

200A type has been added.
High Capacity of Max.
1,000 V DC Cut-off Possible

EP RELAYS(AEP)

Protective construction : Sealed capsule type

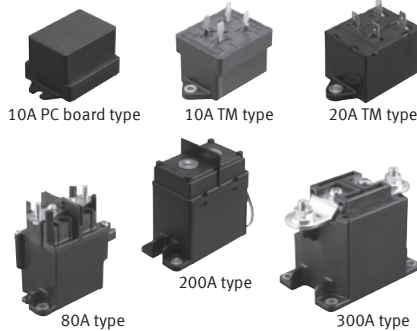

FEATURES

- 1. High-voltage, high-current control capable**
 1,000V DC switching has been achieved thanks to a sealed construction with mixed hydrogen gas and the magnetic arc motion through use of a permanent magnet.
- 2. Compact & Low Operating Sound**
 By using a capsule contact mechanism that is enclosed with hydrogen gas, highcapacity cutoff is possible even with a tiny contact gap. There is little operating sound, which does not change even when large currents are cut off.
- 3. Arc space unnecessary**
 The enclosure box can be made smaller thanks to an arc-space-free construction from which the arc will not get out.
- 4. Safety**
 Since the contacts are enclosed in a sealed capsule structure, the arc will not get out, which ensures safety.
- 5. High contact reliability**
 The contact part is hermetically sealed with H₂ mixed gas, hence the contact resistance remains stable regardless of the ambient conditions.
- 6. Mounting direction is not specified**

The weight of the movable parts is light, and also the restoring force is large, hence the relay is relatively unaffected by gravity.

- 7. Wide selection of models available**
 Types include PC board type (10A), TM type (10A and 20A), Lead wire type (200A) and Connector type (80A and 300A).
- 8. Standard compliance**
 The 10A, 20A, 80A type is UL/C-UL standard certified.

TYPICAL APPLICATIONS

1. Photovoltaic power generation systems
2. Cogeneration systems
3. Construction machinery
4. Welding equipment
5. Battery charge and discharge control
6. AGV (Automatic guided vehicle) (Unmanned transport carts)
7. Inverter control
8. Elevator, etc.

ORDERING INFORMATION

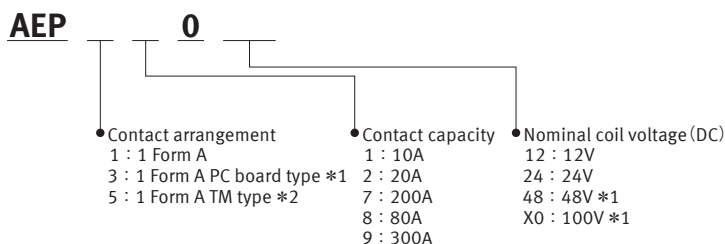

Notes : *1. 10A type only
 *2. 10A and 20A types only
 10A and 80A types are UL/C-UL recognized. 20A type is UL recognized.

TYPES

| Type | Nominal coil voltage | Contact arrangement | Part No. |
|-----------------------|----------------------|---------------------|----------|
| 10A PC board type | 12V DC | 1 Form A | AEP31012 |
| 10A TM type | | | AEP51012 |
| 20A TM type | | | AEP52012 |
| 80A Connector type*1 | | | AEP18012 |
| 200A Lead wire type*2 | | | AEP17012 |
| 300A Connector type*1 | | | AEP19012 |
| 10A PC board type | 24V DC | | AEP31024 |
| 10A TM type | | | AEP51024 |
| 20A TM type | | | AEP52024 |
| 80A Connector type*1 | | | AEP18024 |
| 200A Lead wire type*2 | | | AEP17024 |
| 300A Connector type*1 | | | AEP19024 |
| 10A PC board type | 48V DC | | AEP31048 |
| 10A TM type | | | AEP51048 |
| 10A PC board type | 100V DC | | AEP310X0 |
| 10A TM type | | | AEP510X0 |

Standard packing: 10A: Carton: 25 pcs.; Case: 100 pcs.

20A: Carton: 25 pcs.; Case: 50 pcs.

80A: Carton: 1 pc.; Case: 20 pcs.

200A: Carton: 1 pc.; Case: 10 pcs.

300A: Carton: 1 pc.; Case: 5 pcs.

Notes: *1. One female connector lead wire for connecting is packaged with the 80A and 300A connector types.

-Specifications: Housing: Yazaki 7283-1020 (light gray); Lead wire: 0.5 mm² dia. and 300±10 mm 11.811±.394 inch length

Lead wire coating color: Pin No. 1: white; Pin No. 2: green

*2. Two dedicated M6 bolts is packaged with the 200A type.

RATING

1.Coil data

• Operating characteristics such as 'Operate voltage' and 'Release voltage' are influenced by mounting conditions, ambient temperature, etc.

Therefore, please use the relay within ± 5% of rated coil voltage.

• 'Initial' means the condition of products at the time of delivery.

| Type | Nominal coil voltage | Pick-up voltage (at 20°C 68°F) | Drop-out voltage (at 20°C 68°F) | Nominal coil current [±10%] (at 20°C 68°F) | Nominal operating power (Nominal voltage applied to the coil, at 20°C 68°F) | Max. applied voltage |
|------|---|---|---|--|---|-----------------------------|
| 10A | 12V DC | 75%V or less of nominal voltage (Initial) | 8.3%V or more of nominal voltage (Initial) | 0.103A | 1.24W | 133%V of nominal voltage |
| 20A | | | 4.17%V or more of nominal voltage (Initial) | 0.327A | 3.9W | |
| 80A | | | 8.3%V or more of nominal voltage (Initial) | 0.353A | 4.2W | |
| 200A | | | 8.3%V or more of nominal voltage (Initial) | 0.5A | 6W | |
| 300A | | | 16.7%V or more of nominal voltage (Initial) | 3.3A | When input: 40 W max. (0.1 sec. from time of input) When retained: 4 W max. | |
| 10A | | | 24V DC | 8.3%V or more of nominal voltage (Initial) | 0.052A | |
| 20A | 4.17%V or more of nominal voltage (Initial) | | | 0.163A | 3.9W | |
| 80A | 8.3%V or more of nominal voltage (Initial) | | | 0.176A | 4.2W | |
| 200A | 8.3%V or more of nominal voltage (Initial) | | | 0.25A | 6W | |
| 300A | 16.7%V or more of nominal voltage (Initial) | | | 1.85A | When input: 45 W max. (0.1 sec. from time of input) When retained: 4 W max. | |
| 10A | 48V DC | | | 8.3%V or more of nominal voltage (Initial) | 0.026A | |
| 10A | 100V DC | | | 0.012A | | |

Notes: 1. When using a DC power supply, use one that provides a current capacity leeway of at least 150% of the nominal coil current.

2. The 300A type has a built-in coil current switching circuit. After the nominal coil voltage is applied, it automatically switches in approximately 0.1 seconds.

2. Specifications

| Characteristics | Item | | Specifications | | | | |
|------------------------------------|---|--------------------------|--|--|---|--|--|
| | | | 10A type | 20A type | 80A type | 200A type | 300A type |
| Rating | Contact arrangement | | 1 Form A | | | | |
| | Nominal switching capacity (Resistive load) | | 10A 400V DC | 20A 400V DC | 80A 400V DC | 200A 400V DC | 300A 400V DC |
| | Max. contact allowance voltage | | 1,000V DC | | | | |
| | Short term current (Diameter of connection harness) | | 15A 3min (2mm ²) 30A 30s (2mm ²) | 40A 10min (3mm ²) 60A 1min (3mm ²) | 120A 15min (15mm ²) | 300A 15min (60mm ²) | 400A 10min (100mm ²) |
| | Max. cut-off current | | — | — | 800A 300V DC (1 cycle)* ² | 2,000A 350V DC (1 cycle)* ² | 2,500A 300V DC (3 cycles)* ³ |
| | Overload cut-off rating | | 30A 400V DC (Min. 50 cycles)* ² | 60A 400V DC (Min. 50 cycles)* ² | 120A 400V DC (Min. 50 cycles)* ² | — | 600A 400V DC (Min. 300 cycles) |
| | Reverse cut-off rating | | -20A 200V DC (Min. 10 cycles)* ² | -20A 200V DC (Min. 100 cycles)* ² | -80A 200V DC (Min. 1,000 cycles)* ² | -200A 200V DC (Min. 1,000 cycles)* ² | -300A 200V DC (Min. 100 cycles) |
| | Min. switching capacity | | 1A 6V DC | 1A 12V DC | 1A 12V DC | 1A 12V DC | 1A 24V DC |
| | Contact voltage drop (Initial) | | Max. 0.5V (When carrying current is 10A) | Max. 0.2V (By voltage drop 6V DC 20A) | Max. 0.067V (By voltage drop 6V DC 20A) | Max. 0.1V (When carrying current is 200A) | Max. 0.06V (When carrying current is 300A) |
| Electrical characteristics | Insulation resistance (Initial) | | Min. 100MΩ (at 1,000V DC) Measurement at same location as "Breakdown voltage" section. | | | | |
| | Breakdown voltage (Initial) | Between open contacts | 2,500 Vrms for 1min. (Detection current: 10mA) | | | | |
| | | Between contact and coil | 2,500 Vrms for 1min. (Detection current: 10mA) | | | | |
| | Operate time (at 20°C 68°F) | | Max. 50ms (Nominal voltage applied to the coil, excluding contact bounce time) | | | | |
| | Release time (at 20°C 68°F) | | Max. 30ms (After the nominal operation voltage stops, without diode) | | | | |
| Coil holding voltage* ⁵ | | — | — | 50 to 100% (at 80°C 176°F) | 50 to 100% (at 80°C 176°F) | (Automatic switching) | |
| Mechanical characteristics | Shock resistance | Functional | 10A, 20A (ON), 80A (ON), 200A (ON) and 300A (ON) types: Min. 196 m/s ² (Half-wave pulse of sine wave: 11 ms; detection time: 10μs) 20A (OFF), 80A (OFF), 200A (OFF) and 300A (OFF) types: Min. 98 m/s ² (Half-wave pulse of sine wave: 11 ms; detection time: 10μs) | | | | |
| | | Destructive | Min. 490 m/s ² (Half-wave pulse of sine wave: 6 ms) | | | | |
| | Vibration resistance | Functional | 10 to 200Hz, acceleration 43m/s ² constant (Detection time: 10μs) | | | | |
| | | Destructive | 10 to 200Hz, acceleration 43m/s ² constant (3 directions, each 4 hours) | | | | |
| Expected life | Mechanical | | Min. 10 ⁵ | Min. 2×10 ⁵ | | | |
| | Electrical* ⁴ (Resistive load) | | 10A 400V DC Min. 7.5×10 ⁴ * ² (Switching frequency: 20 times/min) | 20A 400V DC Min. 3×10 ³ * ² 10A 1,000V DC Min. 10 ³ * ² (Switching frequency: 6 times/min) | 80A 400V DC Min. 10 ³ * ² (Switching frequency: 20 times/min) | 200A 400V DC Min. 3×10 ³ * ² (Switching frequency: 20 times/min) 60A 1,000V DC Min. 10 ³ * ² (Switching frequency: 6 times/min) | 300A 400V DC Min. 10 ³ (Switching frequency: 6 times/min) |
| Conditions | Conditions for operation, transport and storage* ¹ | | Ambient temperature: -40°C to +80°C -40°F to +176°F (Storage: Max. +85°C +185°F), Humidity: 5 to 85% R.H. (Not freezing and condensing at low temperature) | | | | |
| Unit weight | | Approx. 80 g 2.820oz | Approx. 180 g 6.349oz | Approx. 400 g 14.11oz | Approx. 600 g 21.16oz | Approx. 750 g 26.46oz | |

Notes: *1. The upper limit of the ambient temperature is the maximum temperature that can satisfy the coil temperature rise value.

Refer to Usage, transport and storage conditions in NOTES.

*2. Conditions: Varistor used for coil surge absorption. Note: if a diode is used the life will be lower.

*3. Condition: Switches rated number of 10 cycles each time there is a 2,500A cut-off.

*4. Please refer to the reference data on the following page for switching and cut-off at 400 V DC and higher.

*5. Coil holding voltage is the coil voltage after 100 ms following application of the nominal coil voltage.

REFERENCE DATA

Note: The switching life curves are rough guides for when using over the nominal values. Be sure to conduct tests with the actual device to verify your specifications.

1.-(1) Ambient temperature characteristics (10A type)

Tested sample : AEP31012, 3 pcs.

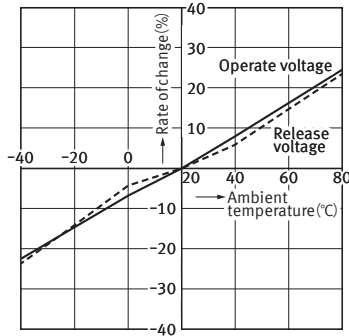

1.-(2) Ambient temperature characteristics (20A type)

Tested sample : AEP52012, 3 pcs.

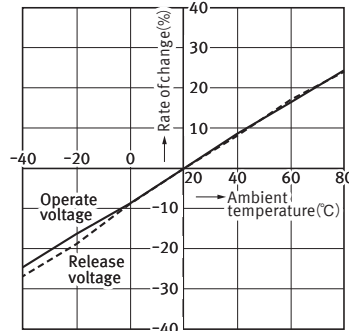

1.-(3) Ambient temperature characteristics (80A type)

Tested sample : AEP18012, 3 pcs.

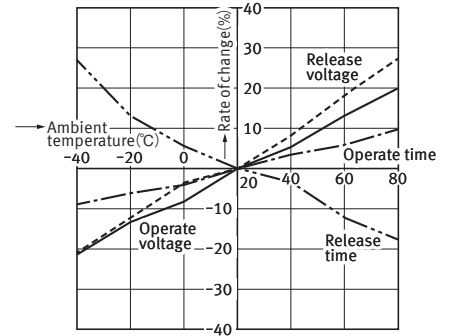

1.-(4) Ambient temperature characteristics (200A type)

Tested sample : AEP17012, 3 pcs.

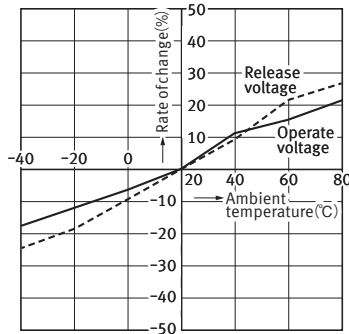

1.-(5) Ambient temperature characteristics (300A type)

Tested sample : AEP19012, 3 pcs.

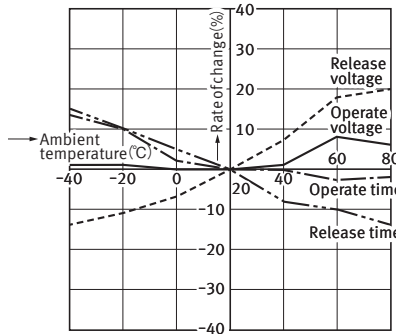

2.-(1) Max. value for switching capacity (10A and 20A types)

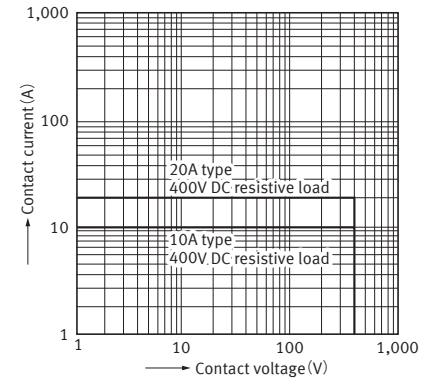

2.-(2) Max. value for switching capacity (80A, 200A and 300A types)

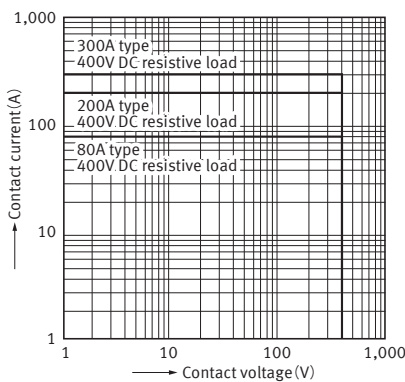

3.-(1) Switching life and cut-off curves (10A type)

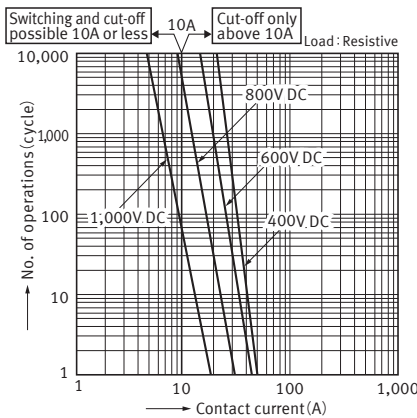

3.-(2) Switching life and cut-off curves (20A type)

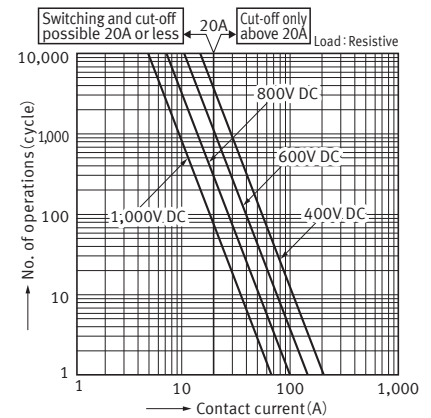

3.-(3) Switching life and cut-off curves (80A type)

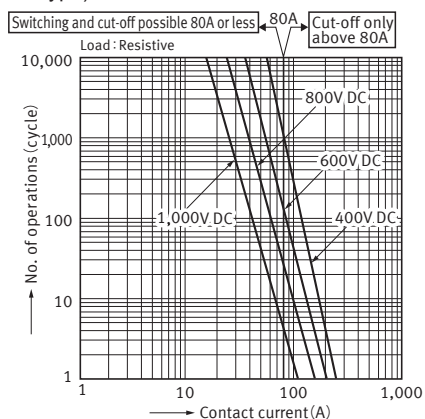

3.-(4) Switching life and cut-off curves (200A type)

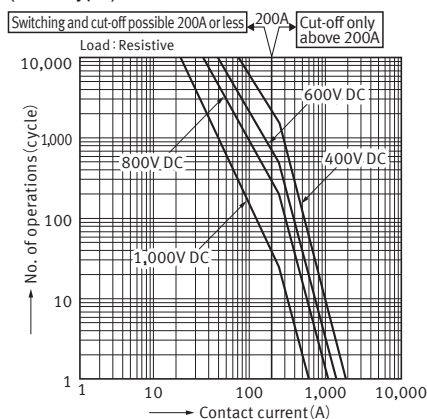

3.-(5) Switching life and cut-off curves (300A type)

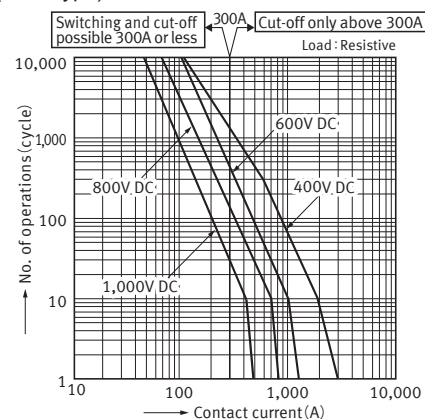

4.-(1) Carrying performance curve (10A and 20A type)

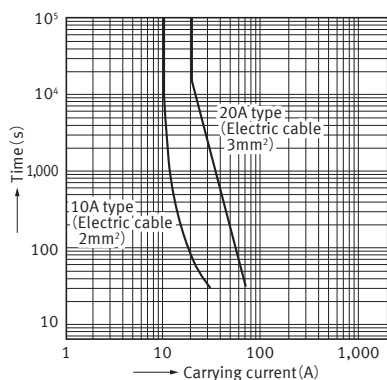

4.-(2) Carrying performance curve (80A, 200A and 300A types)

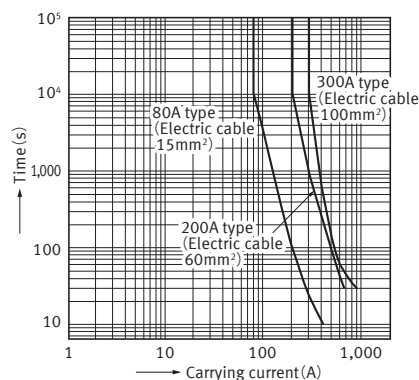

DIMENSIONS (mm)

1. 10A PC board type

CAD The CAD data of the products with a "CAD" mark can be downloaded from our Website.

CAD

External dimensions

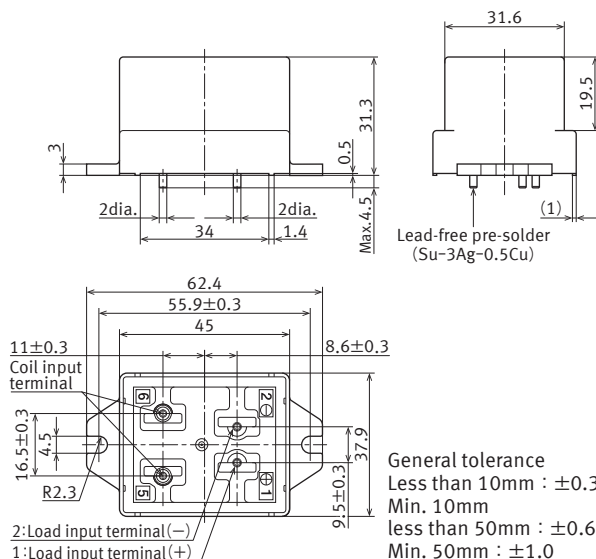

Schematic (Bottom view)

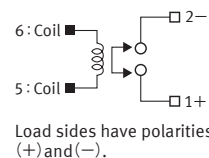

PC board pattern (Bottom view)

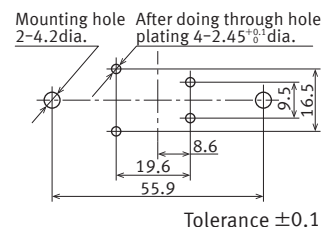

- Notes : 1. We recommend through hole plating with land on both sides.
 2. Be careful of the insulation distance between land patterns with regards to the circuit voltage you will use.

2. 10A TM type

CAD

External dimensions

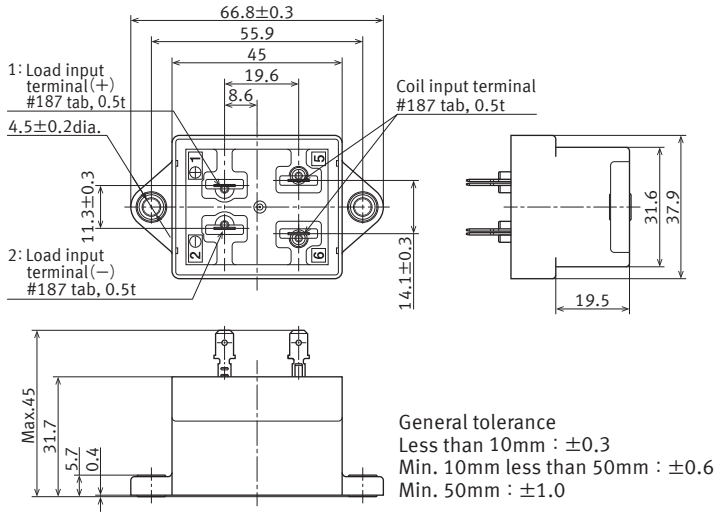

Schematic (Top view)

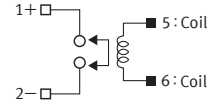

Load sides have polarities (+) and (-).

Panel cut-off

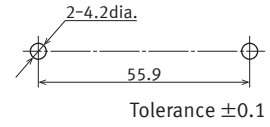

3. 20A TM type

CAD

External dimensions

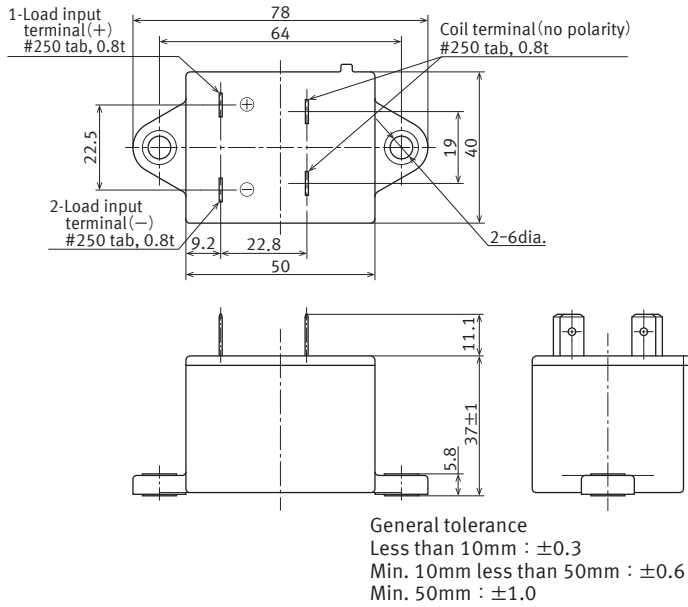

Schematic (Bottom view)

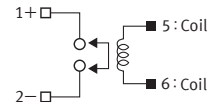

Load sides have polarities (+) and (-).

Panel cut-off

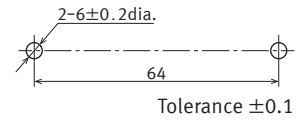

4. 80A Connector type

CAD

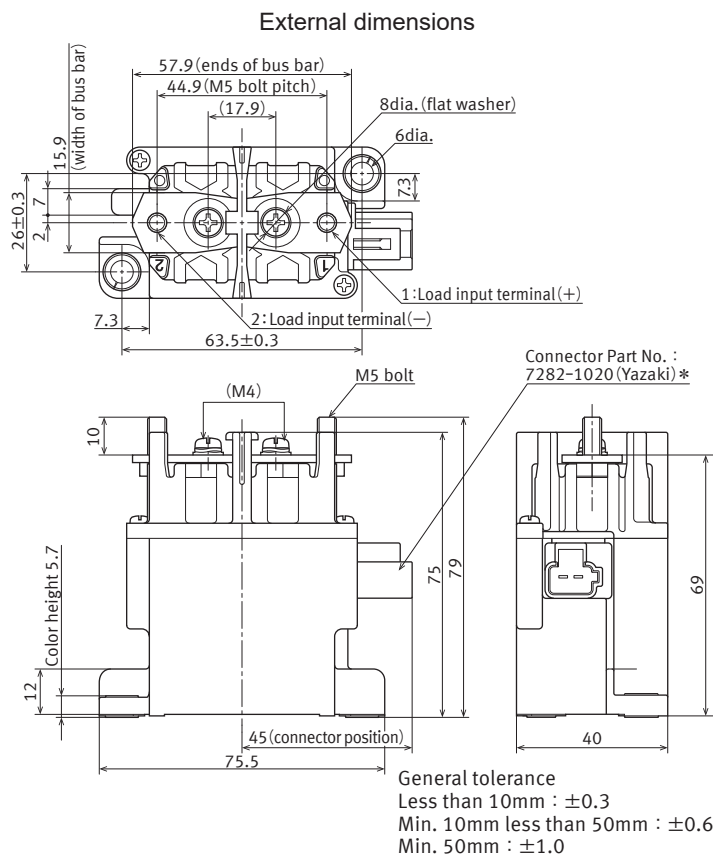

Schematic (Top view)

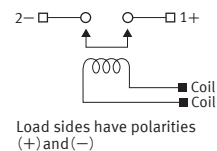

Panel cut-off

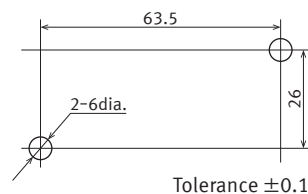

*Accessories (included)

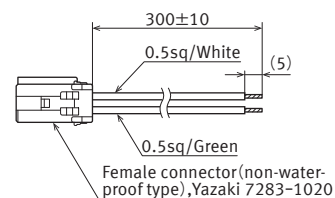

5. 200A Lead wire type

CAD

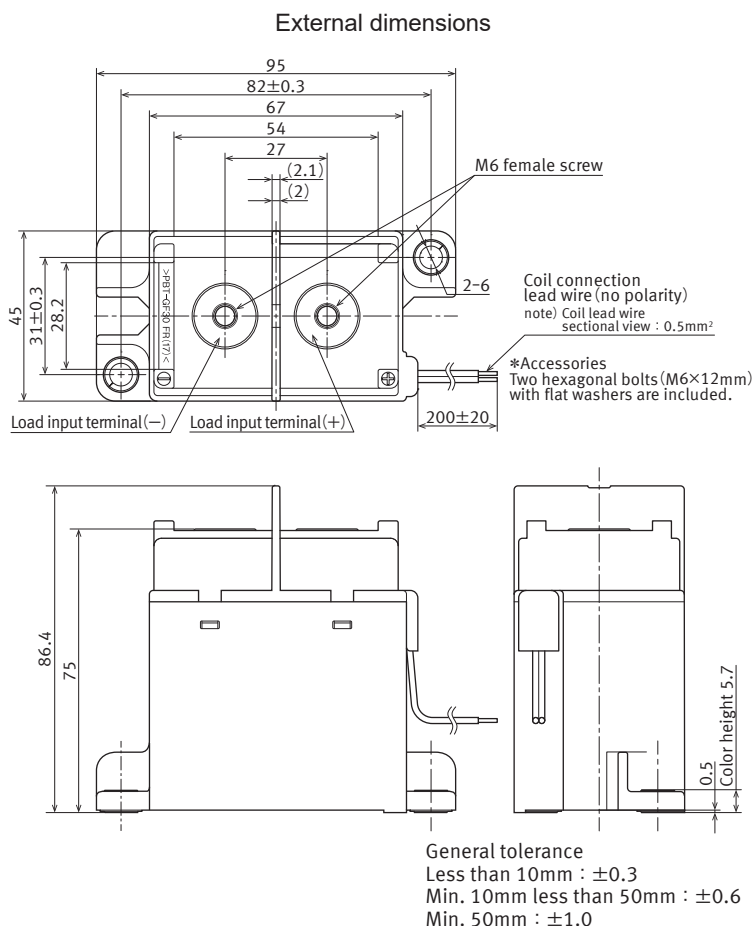

Schematic (Bottom view)

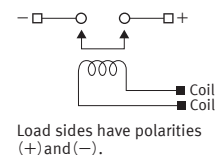

PC board pattern (Bottom view)

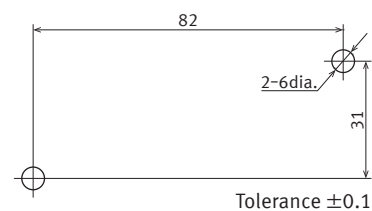

6. 300A Connector type

CAD

External dimensions

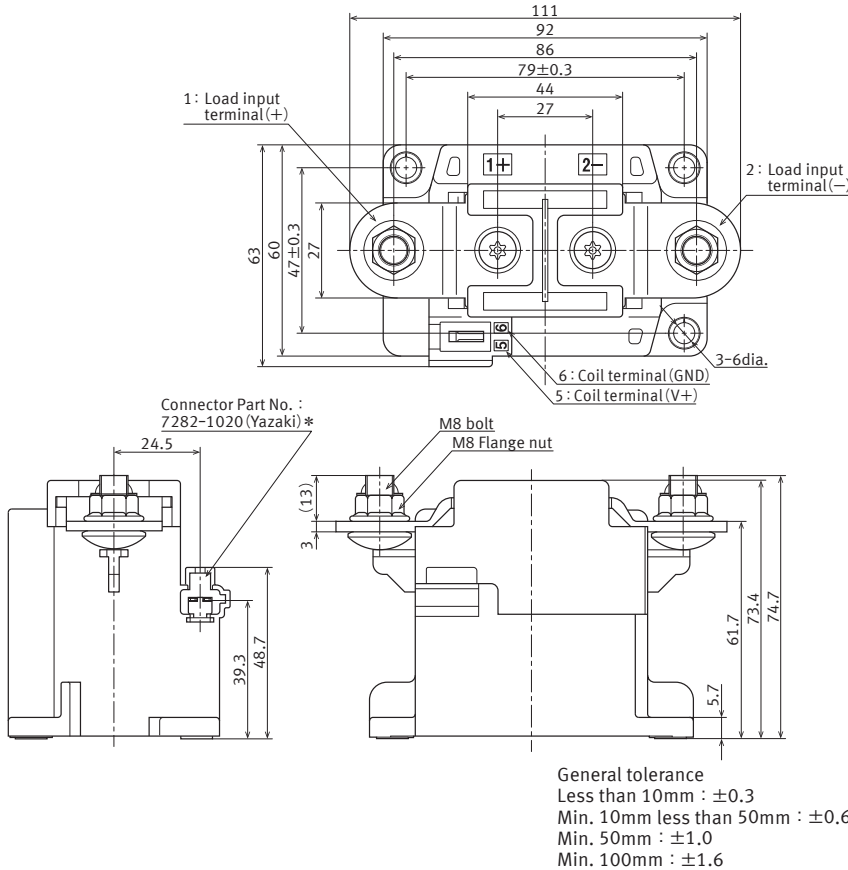

Schematic (Top view)

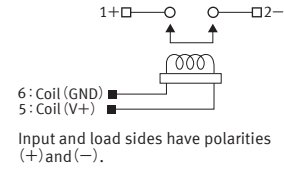

Panel cut-off

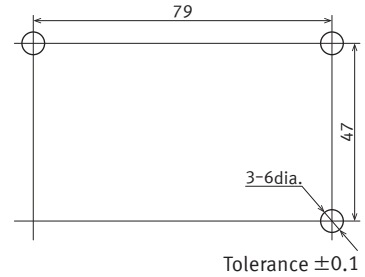

*Accessories (included)

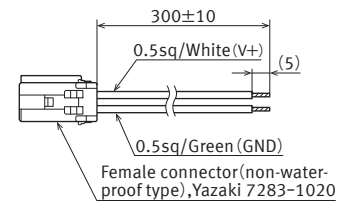

General tolerance
 Less than 10mm : ±0.3
 Min. 10mm less than 50mm : ±0.6
 Min. 50mm : ±1.0
 Min. 100mm : ±1.6

SAFETY STANDARDS

| Product name | File No. | UL/C-UL (Recognized) |
|--------------|----------|--------------------------------------|
| | | Contact rating |
| 10A | E43149 | 10A 400V DC, 10A 277V AC Resistive |
| 20A* | (E43149) | (20A 400V DC, 20A 277V AC Resistive) |
| 80A | E43149 | 80A 400V DC, 80A 277V AC Resistive |

*20A type: only UL (Recognized)

NOTES

- For cautions for use, please read "GENERAL APPLICATION GUIDELINES" on page B-1.
- When installing the relay, always use washers to prevent the screws from loosening.
Tighten each screw within the rated range given below. Exceeding the maximum torque may result in breakage. Mounting is possible in either direction.
 - M5 screw (20A, 80A, 200A and 300A main unit mounting section): 3 to 4N·m
 - M4 screw (10A PC board type main unit mounting section): 0.98 to 1.2N·m (10A TM type main unit mounting section): 1.8 to 2.7N·m

Recommended securing torque on load side terminals

 - 80A/M5 bolt: 3.5 to 6.5 N·m
 - 200A/M6 bolt: 6 to 8 N·m
 - 300A/M8 bolt: 10 to 12 N·m
- The contacts of the relay are polarized. Please follow instructions in the connection schematic when connecting the contacts.
We recommend installing a surge protector varistor for the 10A, 20A, 80A and 200A types. Please note that when using a diode, the switching speed may decrease and cause a reduction in cut-off performance. For the 300A type, separate surge countermeasures are not required, because it contains a built-in surge absorbing element.
 - Recommend varistor; Amount of proof energy: Min. 1 J
 - Varistor voltage: 1.5 to 3.0 times of nominal voltage
- Do not use a relay if it has been dropped.
- Avoid mounting the relay in strong magnetic fields (near a transformer or magnet) or close to an object that radiates heat.
- Electrical life
This relay is a DC high-voltage switch. In its final breakdown mode, it may lose the ability to provide the proper cut-off. Therefore, do not exceed the indicated switching capacity and life. (Please treat the relay as a product with limited life and replace it when necessary.)
In the event that the relay loses cut-off ability, there is a possibility that burning may spread to surrounding parts, so configure the layout so that the power is turned off within one second and from the point of view of safety, consider installing a failsafe circuit in the device. Also, in order to avoid increased contact resistance, do not operate when there is no switching load.

- 7. Permeation life of internal gas**
This relay uses a hermetically encased contact (capsule contact) with gas inside. The gas has a permeation life that is affected by the temperature inside the capsule contact (ambient temperature + temperature rise due to flow of electrical current). Therefore, please do not exceed the operation ambient and storage ambient temperatures given in the specifications.
- 8. Do not disassemble the relay.**
Please note that disassembling the relay will invalidate the warranty.
- 9. If the power is turned off and then immediately on after applying the rated voltage (current) continuously to the relay's coil and contact, the resistance of the coil will increase due to a rise in the coil temperature. This causes the pick-up voltage to rise, and possibly exceed the rated pick-up voltage. In these circumstances, take measures such as reducing the load current, limiting the duration of current flow, and applying a coil voltage higher than the rated operating voltage.**
- 10. Pure DC current should be applied to the coil. If it includes ripple, the ripple factor should be less than 5%. However, check the actual circuit since the characteristics may be slightly different. The power supply waveform supplied to the coil should be rectangular. Also, the 300A type has a built-in dedicated drive circuit. It may not operate normally unless the rise time is 10 ms or less.**
- 11. Don't exceed maximum coil voltage. Exceeding maximum allowable coil voltage on continuous basis will damage the relay and could cause failure.**
If you will be using with a load
- 12. voltage that exceeds 400 V DC, please be sure to verify operation on the actual device, referring to the switching life curves (reference data). You must absolutely avoid continual use in which the load current exceeds the rated value. This will cause abnormal heating.**
- 13. The rated control capacity and life are given as general guides.**
It is important to conduct sufficient tests on the actual device, because contact properties and working life will differ considerably depending on the type of load and conditions.
- 14. Main contact ratings in the ratings apply to when there is a resistive load. If you are using an inductive load (L load) such that $L/R > 1$ ms, add surge protection in parallel with the inductive load. If this is not done, the electrical life will decrease and cut-off failure may occur.**
In order to prevent contact welding when using a capacitive load (C load) such as a capacitor load, please make the inrush current setting more than two times that of the nominal current. Please contact us for more information.
- 15. Be careful that foreign matter and oils and fats kind don't stick to the main terminal parts because it is likely to cause terminal parts to give off unusual heat. Also, please use the following materials for connected harnesses and bus bars.**
10A TM type:
#187, 0.5 mm board thickness
20A TM type:
#250, 0.8 mm board thickness
tab terminal (JIS C289-1999 compliant, flat type connection terminal)
- Harness nominal cross-sectional area
Load input terminal side;
10A TM type: min. 2.0 mm²
20A TM type: min. 3.0 mm²
80A type: min. 15 mm²
200A type: min. 60 mm²
300A type: min. 100 mm²
Coil input terminal side; 10A and 20A TM types: min. 0.3 mm²
- 16. Use 40 to 70N or 50 to 80N of force as a guide to fasten the terminal connected to the 10A TM and 20A TM types. Please use caution when inserting or removing the terminal as the relay tab terminal may cause injury. Also, unstable conductivity and abnormal terminal heating may occur; therefore, please check that there is no deformation of or foreign objects on the faston terminals (blade receptacle) you will be connecting. Use JIS C2809 (or IEC60760) certified products.**
- 17. Place the PC board mount type (10A PC board type) securely by hand soldering after attaching it using M4 screw. Don't submerge assembled board in cleaning solvent or water. Also, be careful not let flux overflow up from the PC board or adhere to the base of the relay.**
Recommended hand soldering conditions
• Soldering iron: 30 to 60 W
• Tip temperature: 400°C 752°F
• Solder time: within approx. 5 seconds
- 18. Make sure the power is turned off when wiring.**
- 19. Incorrect wiring may cause unexpected malfunction and failure.**
- 20. Regarding AC cutoff, although there is no contact polarity, generally it is thought that the electrical life will shorten due to cutoff in the reverse direction, compared to DC cutoff. Confirm electrical life using actual load. In the case of DC cut-off, please note the contact polarity.**
- 21. Lead-free solder (tin, silver and copper) is used as pre-solder for the terminals of the PC board mount type (10A PC board type).**
- 22. The warranted tensile strength of the female connector lead wire used for connection that comes with the 80A and 300A connector type when attaching it to the relay body is 98N. Avoid excessive tension as this is a cause of broken wires and damage. Also, insert the female connector deeply and make sure the connection is secure.**
- 23. Condensation will occur during sudden temperature changes in hot and humid environments. Caution is required, because condensation will cause a decrease in the insulation resistance between the terminals.**
- 24. Please note that if the 80 A type is used only with excessive load, the contact resistance may possibly increase.**

Please refer to "the latest product specifications" when designing your product.

• Requests to customers :

<https://industrial.panasonic.com/ac/e/salespolicies/>

GUIDELINES FOR POWER RELAYS AND HIGH-CAPACITY DC CUT OFF RELAYS USAGE

For cautions for use, please read “GUIDELINES FOR RELAY USAGE”.

https://industrial.panasonic.com/ac/e/control/relay/cautions_use/index.jsp

Precautions for Coil Input

■ Long term current carrying

A circuit that will be carrying a current continuously for long periods without relay switching operation. (circuits for emergency lamps, alarm devices and error inspection that, for example, revert only during malfunction and output warnings with form B contacts) Continuous, long-term current to the coil will facilitate deterioration of coil insulation and characteristics due to heating of the coil itself.

For circuits such as these, please use a magnetic-hold type latching relay. If you need to use a single stable relay, use a sealed type relay that is not easily affected by ambient conditions and make a failsafe circuit design that considers the possibility of contact failure or disconnection.

■ DC Coil operating power

Steady state DC current should be applied to the coil. The wave form should be rectangular. If it includes ripple, the ripple factor should be less than 5%.

However, please check with the actual circuit since the electrical characteristics may vary. The rated coil voltage should be applied to the coil and the set/reset pulse time of latching type relay differs for each relays, please refer to the relay's individual specifications.

■ Coil connection

When connecting coils of polarized relays, please check coil polarity (+,-) at the internal connection diagram (Schematic). If any wrong connection is made, it may cause unexpected malfunction, like abnormal heat, fire and so on, and circuit do not work. Avoid impressing voltages to the set coil and reset coil at the same time.

Ambient Environment

● Usage, Transport, and Storage Conditions

During usage, storage, or transportation, avoid locations subjected to direct sunlight and maintain normal temperature, humidity and pressure conditions.

● Temperature/Humidity/Pressure

When transporting or storing relays while they are tube packaged, there are cases the temperature may differ from the allowable range. In this case be sure to check the individual specifications. Also allowable humidity level is influenced by temperature, please check charts shown below and use relays within mentioned conditions. (Allowable temperature values differ for each relays, please refer to the relay's individual specifications.)

1) Temperature:

The tolerance temperature range differs for each relays, please refer to the relay's individual specifications

2) Humidity:

5 to 85 % RH

3) Pressure:

86 to 106 kPa

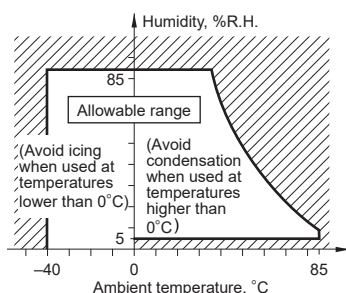

■ Maximum allowable voltage and temperature rise

Proper usage requires that the rated coil voltage be impressed on the coil. Note, however, that if a voltage greater than or equal to the maximum continuous voltage is impressed on the coil, the coil may burn or its layers short due to the temperature rise. Furthermore, do not exceed the usable ambient temperature range listed in the catalog.

■ Operate voltage change due to coil temperature rise (Hot start)

In DC relays, after continuous passage of current in the coil, if the current is turned OFF, then immediately turned ON again, due to the temperature rise in the coil, the pick-up voltage will become somewhat higher. Also, it will be the same as using it in a higher temperature atmosphere. The resistance/temperature relationship for copper wire is about 0.4% for 1°C, and with this ratio the coil resistance increases. That is, in order to operate of the relay, it is necessary that the voltage be higher than the pick-up voltage and the pick-up voltage rises in accordance with the increase in the resistance value. However, for some polarized relays, this rate of change is considerably smaller.

● Dew condensation

Condensation occurs when the ambient temperature drops suddenly from a high temperature and humidity, or the relay is suddenly transferred from a low ambient temperature to a high temperature and humidity. Condensation causes the failures like insulation deterioration, wire disconnection and rust etc. Panasonic Corporation does not guarantee the failures caused by condensation.

The heat conduction by the equipment may accelerate the cooling of device itself, and the condensation may occur.

Please conduct product evaluations in the worst condition of the actual usage. (Special attention should be paid when high temperature heating parts are close to the device. Also please consider the condensation may occur inside of the device.)

● Icing

Condensation or other moisture may freeze on relays when the temperature become lower than 0°C. This icing causes the sticking of movable portion, the operation delay and the contact conduction failure etc. Panasonic Corporation does not guarantee the failures caused by the icing.

The heat conduction by the equipment may accelerate the cooling of relay itself and the icing may occur. Please conduct product evaluations in the worst condition of the actual usage.

● Low temperature and low humidity

The plastic becomes brittle if the switch is exposed to a low temperature, low humidity environment for long periods of time.

● High temperature and high humidity

Storage for extended periods of time (including transportation periods) at high temperature or high humidity levels or in atmospheres with organic gases or sulfide gases may cause a sulfide film or oxide film to form on the surfaces of the contacts and/or it may interfere with the functions. Check out the atmosphere in which the units are to be stored and transported.

GUIDELINES FOR POWER RELAYS AND HIGH-CAPACITY DC CUT OFF RELAYS USAGE

●Package

In terms of the packing format used, make every effort to keep the effects of moisture, organic gases and sulfide gases to the absolute minimum.

●Silicon

When a source of silicone substances (silicone rubber, silicone oil, silicone coating materials and silicone filling materials etc.) is used around the relay, the silicone gas (low molecular siloxane etc.) may be produced.

This silicone gas may penetrate into the inside of the relay. When the relay is kept and used in this condition, silicone compound may adhere to the relay contacts which may cause the contact failure. Do not use any sources of silicone gas around the relay (Including plastic seal types).

●NOx Generation

When relay is used in an atmosphere high in humidity to switch a load which easily produces an arc, the NOx created by the arc and the water absorbed from outside the relay combine to produce nitric acid. This corrodes the internal metal parts and adversely affects operation. Avoid use at an ambient humidity of 85%RH or higher (at 20°C). If use at high humidity is unavoidable, please contact our sales representative.

Others

■Cleaning

- 1) Although the environmentally sealed type relay (plastic sealed type, etc.) can be cleaned, avoid immersing the relay into cold liquid (such as cleaning solvent) immediately after soldering. Doing so may deteriorate the sealing performance.
- 2) Cleaning with the boiling method is recommended(The temperature of cleaning liquid should be 40°C or lower).
Avoid ultrasonic cleaning on relays. Use of ultrasonic cleaning may cause breaks in the coil or slight sticking of the contacts due to ultrasonic energy.

Please refer to **"the latest product specifications"** when designing your product.

•Requests to customers:

<https://industrial.panasonic.com/ac/e/salespolicies/>

Please contact

Panasonic Corporation

Electromechanical Control Business Division

■ 1006, Oaza Kadoma, Kadoma-shi, Osaka 571-8506, Japan
industrial.panasonic.com/ac/e/

Panasonic[®]

©Panasonic Corporation 2019