

## Features

- Ultra low leakage: nA level
- Operating voltage: 24V
- Low Capacitance: 3pF
- Complies with following standards:
  - IEC 61000-4-2 (ESD) immunity test
    - Air discharge:  $\pm 25\text{kV}$
    - Contact discharge:  $\pm 17\text{kV}$
  - IEC 61000-4-4 (EFT) 40A (5/50ns)
- RoHS Compliant

## Ordering Information

Part Number	Qty per Reel	Reel Size
ESD24VB3-1006	10000	7"

## Mechanical Characteristics

- DFN1006-2L package
- Lead Finish: Matte Tin
- UL Flammability Classification Rating 94V-0

## Applications

- USB 2.0 power and data line
- Set-top box and digital TV
- Digital video interface (DVI)
- Notebook Computers
- SIM Ports
- 10/100 Ethernet

## Dimensions

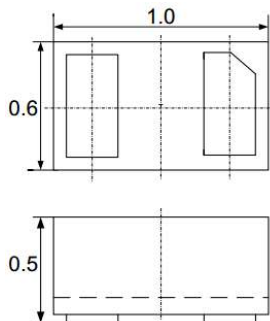

## Pin Configuration

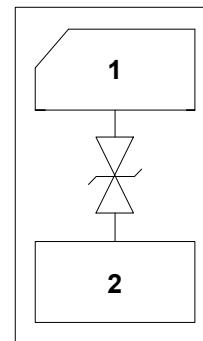

**Marking: EB**

**Absolute Maximum Ratings** (Tamb=25°C unless otherwise specified)

Parameter	Symbol	Value	Unit
ESD per IEC 61000-4-2 (Air)	VESD	± 25	kV
ESD per IEC 61000-4-2 (Contact)		± 17	
Operating Temperature Range	TJ	-55 to +155	°C
Storage Temperature Range	Tstg	-40 to +125	°C

**Electrical Characteristics** (TA=25°C unless otherwise specified)

Symbol	Parameter
$V_{RWM}$	Nominal Reverse Working Voltage
$I_R$	Reverse Leakage Current @ $V_{RWM}$
$V_{BR}$	Reverse Breakdown Voltage @ $I_T$
$I_T$	Test Current for Reverse Breakdown
$V_C$	Clamping Voltage @ $I_{PP}$
$I_{PP}$	Maximum Peak Pulse Current
$C_{ESD}$	Parasitic Capacitance
$V_R$	Reverse Voltage
f	Small Signal Frequency

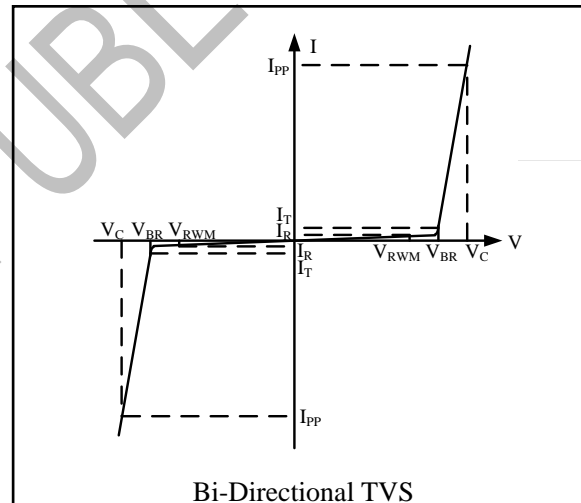

Symbol	Test Condition	Minimum	Typical	Maximum	Units
$V_{RWM}$				24.0	V
$I_R$	$V_{RWM} = 24V, T = 25^\circ C$ Between I/O and I/O		0.01	0.1	$\mu A$
$V_{BR}$	$I_T = 1mA$ Between I/O and I/O	26			V
$V_C$	$I_{PP} = 1A, t_p = 8/20\mu s$ Between I/O and I/O		40		V
$C_{ESD}$	$V_R = 0V, f = 1MHz$ Between I/O and I/O		3	5	pF

## Characteristic Curves

Fig1. 8/20 $\mu$ s Pulse Waveform

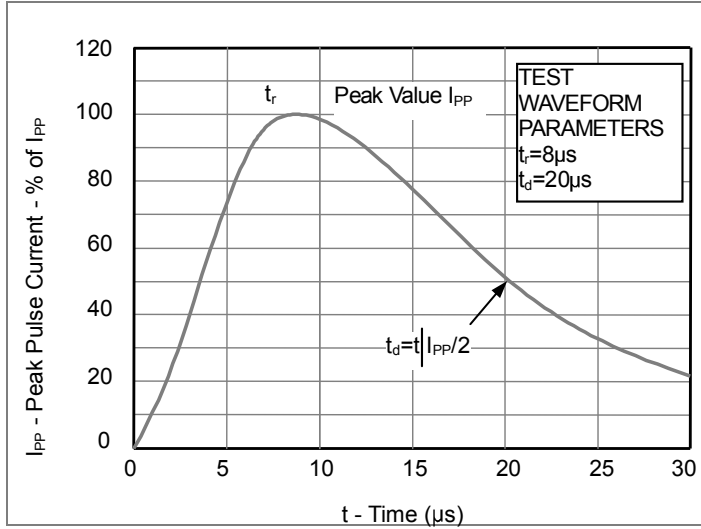

Fig2. ESD Pulse Waveform (according to IEC 61000-4-2)

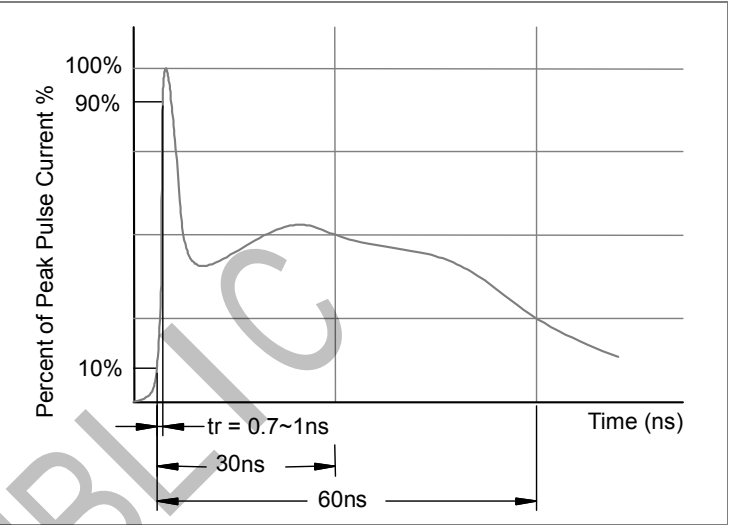
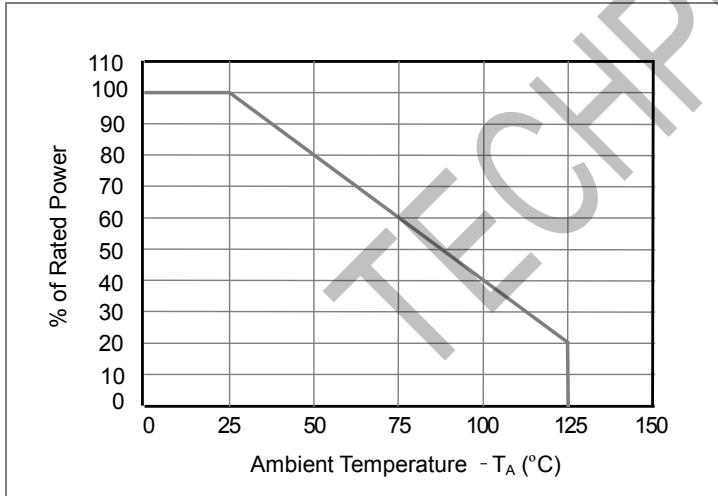
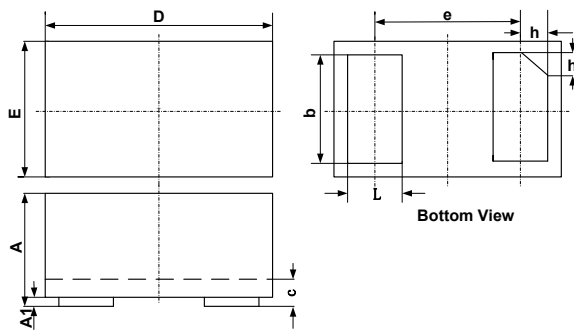

Fig3. Power Derating Curve



### Outline Drawing - DFN1006-2



SYM	DIMENSIONS					
	MILLIMETERS			INCHES		
	MIN	NOM	MAX	MIN	NOM	MAX
A	0.45	0.50	0.55	0.018	0.020	0.022
A1	0.00	0.02	0.05	0.000	0.001	0.002
b	0.45	0.50	0.55	0.018	0.020	0.022
c	0.12	0.15	0.18	0.005	0.006	0.007
D	0.95	1.00	1.05	0.037	0.039	0.041
e	0.65 BSC			0.026 BSC		
E	0.55	0.60	0.65	0.022	0.024	0.026
L	0.20	0.25	0.30	0.008	0.010	0.012
h	0.07	0.12	0.17	0.003	0.005	0.007

### Land Pattern - DFN1006-2

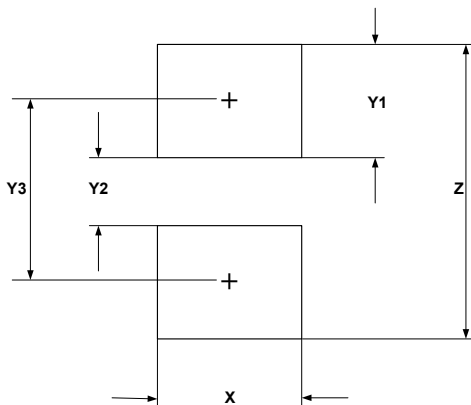

SYM	DIMENSIONS	
	MILLIMETERS	INCHES
X	0.60	0.024
Y1	0.50	0.020
Y2	0.30	0.012
Y3	0.80	0.032
Z	1.30	0.052