

**SUPER-SMALL PACKAGE HIGH-PRECISION
VOLTAGE DETECTOR**

The S-808xxC series is a series of high-precision voltage detectors developed using CMOS process. The detection voltage is fixed internally with an accuracy of $\pm 2.0\%$. Two output forms, Nch open-drain and CMOS output, are available. Super-low current consumption and miniature package lineup can meet demand from the portable device applications.

■ Features

- Super-low current consumption 1.3 μA typ. (detection voltage ≤ 1.4 V, at $V_{\text{DD}} = 1.5$ V)
0.8 μA typ. (detection voltage ≥ 1.5 V, at $V_{\text{DD}} = 3.5$ V)
- High-precision detection voltage $\pm 2.0\%$
- Operating voltage range 0.65 V to 5.0 V (detection voltage ≤ 1.4 V)
0.95 V to 10.0 V (detection voltage ≥ 1.5 V)
- Hysteresis characteristics 5% typ.
- Detection voltage 0.8 V to 6.0 V (0.1 V step)
- Output form Nch open-drain output (Active Low)
CMOS output (Active Low)
- Lead-free, Sn 100%, halogen-free^{*1}

*1. Refer to “**■ Product Name Structure**” for details.

■ Applications

- Battery checkers
- Power failure detectors
- Power monitor for portable equipments such as pagers, calculators, electronic notebooks and remote controllers.
- Constant voltage power monitor for cameras, video equipments and communication devices.
- Power monitor for microcomputers and reset for CPUs.

■ Packages

- SC-82AB
- SOT-23-5
- SOT-89-3
- SNT-4A
- TO-92

■ Block Diagrams

1. Nch Open-drain Output Products



*1. Parasitic diode

Figure 1

2. CMOS Output Products



*1. Parasitic diode

Figure 2

■ **Product Name Structure**

The detection voltage, output form and packages for S-808xxC Series can be selected at the user's request. Refer to the "1. Product Name" for the construction of the product name, "2. Packages" regarding the package drawings and "3. Product Name List" for the full product names.

1. Product Name

1-1. SC-82AB, SOT-23-5, SOT-89-3



*1. Refer to the tape specifications at the end of this book.

*2. Refer to the **Table 1 and 3** in the "3. Product Name List"

1-2. SNT-4A



*1. Refer to the tape specifications at the end of this book.

*2. Refer to the **Table 2 and 4** in the "3. Product Name List"

1-3. TO-92

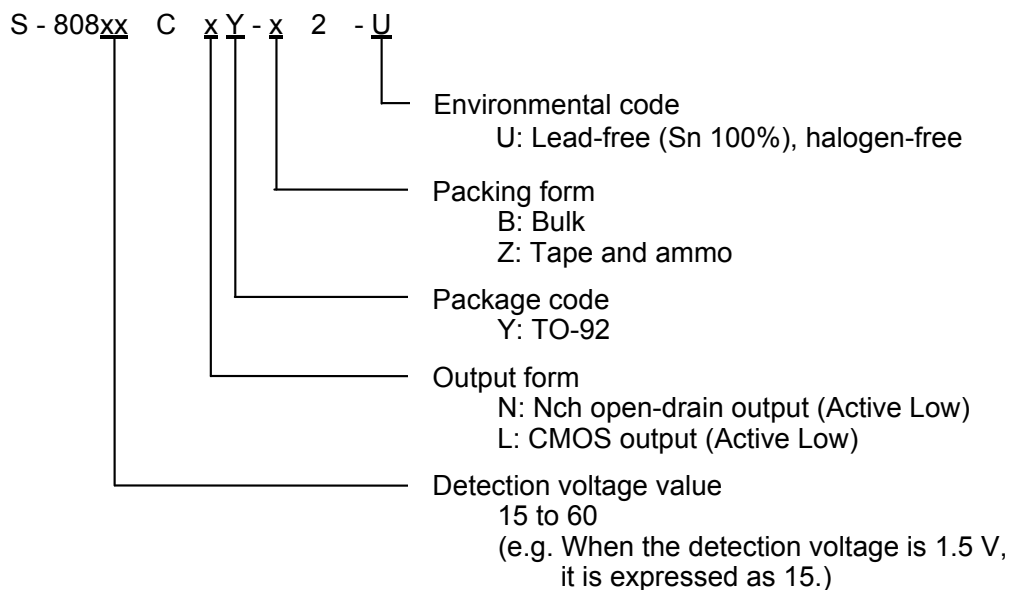

2. Packages

| Package name | Drawing code | | | | |
|-----------------------|--------------|------------------------------|--------------|--------------|--------------|
| | Package | Tape | Reel | Zigzag | Land |
| SC-82AB | NP004-A-P-SD | NP004-A-C-SD NP004-A-C-S1 | NP004-A-R-SD | — | — |
| SOT-23-5 | MP005-A-P-SD | MP005-A-C-SD | MP005-A-R-SD | — | — |
| SOT-89-3 | UP003-A-P-SD | UP003-A-C-SD | UP003-A-R-SD | — | — |
| SNT-4A | PF004-A-P-SD | PF004-A-C-SD | PF004-A-R-SD | — | PF004-A-L-SD |
| TO-92 (Bulk) | YS003-D-P-SD | — | — | — | — |
| TO-92 (Tape and ammo) | YZ003-E-P-SD | YZ003-E-C-SD | — | YZ003-E-Z-SD | — |

3. Product Name List

3-1. Nch Open-drain Output Products

Table 1 (1/2)

| Detection voltage range | Hysteresis width (Typ.) | SC-82AB | SOT-23-5 | SOT-89-3 |
|-------------------------|---------------------------|--------------------|--------------------|----------------------------------|
| 0.8 V±2.0 % | 0.034 V | S-80808CNNB-B9MT2x | — | — |
| 0.9 V±2.0 % | 0.044 V | S-80809CNNB-B9NT2x | — | — |
| 1.0 V±2.0 % | 0.054 V | S-80810CNNB-B9OT2x | — | — |
| 1.1 V±2.0 % | 0.064 V | S-80811CNNB-B9PT2x | — | — |
| 1.2 V±2.0 % | 0.073 V | S-80812CNNB-B9QT2x | — | — |
| 1.3 V±2.0 % | 0.083 V | S-80813CNNB-B9RT2x | — | — |
| 1.4 V±2.0 % | 0.093 V | S-80814CNNB-B9ST2x | — | — |
| 1.5 V±2.0 % | 0.075 V | S-80815CNNB-B8AT2x | S-80815CNMC-B8AT2x | S-80815CNUA-B8AT2x |
| 1.6 V±2.0 % | 0.080 V | S-80816CNNB-B8BT2x | S-80816CNMC-B8BT2x | S-80816CNUA-B8BT2x |
| 1.7 V±2.0 % | 0.085 V | S-80817CNNB-B8CT2x | S-80817CNMC-B8CT2x | S-80817CNUA-B8CT2x |
| 1.8 V±2.0 % | 0.090 V | S-80818CNNB-B8DT2x | S-80818CNMC-B8DT2x | S-80818CNUA-B8DT2x |
| 1.9 V±2.0 % | 0.095 V | S-80819CNNB-B8ET2x | S-80819CNMC-B8ET2x | S-80819CNUA-B8ET2x |
| 2.0 V±2.0 % | 0.100 V | S-80820CNNB-B8FT2x | S-80820CNMC-B8FT2x | S-80820CNUA-B8FT2x |
| 2.1 V±2.0 % | 0.105 V | S-80821CNNB-B8GT2x | S-80821CNMC-B8GT2x | S-80821CNUA-B8GT2x |
| 2.2 V±2.0 % | 0.110 V | S-80822CNNB-B8HT2x | S-80822CNMC-B8HT2x | S-80822CNUA-B8HT2x |
| 2.3 V±2.0 % | 0.115 V | S-80823CNNB-B8IT2x | S-80823CNMC-B8IT2x | S-80823CNUA-B8IT2x |
| 2.4 V±2.0 % | 0.120 V | S-80824CNNB-B8JT2x | S-80824CNMC-B8JT2x | S-80824CNUA-B8JT2x |
| 2.4 V typ. | 4.4 ± 0.1 V ^{*1} | — | — | S-80824KNUA-D2BT2x ^{*2} |
| 2.5 V±2.0 % | 0.125 V | S-80825CNNB-B8KT2x | S-80825CNMC-B8KT2x | S-80825CNUA-B8KT2x |
| 2.6 V±2.0 % | 0.130 V | S-80826CNNB-B8LT2x | S-80826CNMC-B8LT2x | S-80826CNUA-B8LT2x |
| 2.7 V±2.0 % | 0.135 V | S-80827CNNB-B8MT2x | S-80827CNMC-B8MT2x | S-80827CNUA-B8MT2x |
| 2.8 V±2.0 % | 0.140 V | S-80828CNNB-B8NT2x | S-80828CNMC-B8NT2x | S-80828CNUA-B8NT2x |
| 2.9 V±2.0 % | 0.145 V | S-80829CNNB-B8OT2x | S-80829CNMC-B8OT2x | S-80829CNUA-B8OT2x |
| 3.0 V±2.0 % | 0.150 V | S-80830CNNB-B8PT2x | S-80830CNMC-B8PT2x | S-80830CNUA-B8PT2x |
| 3.1 V±2.0 % | 0.155 V | S-80831CNNB-B8QT2x | S-80831CNMC-B8QT2x | S-80831CNUA-B8QT2x |
| 3.2 V±2.0 % | 0.160 V | S-80832CNNB-B8RT2x | S-80832CNMC-B8RT2x | S-80832CNUA-B8RT2x |
| 3.3 V±2.0 % | 0.165 V | S-80833CNNB-B8ST2x | S-80833CNMC-B8ST2x | S-80833CNUA-B8ST2x |
| 3.4 V±2.0 % | 0.170 V | S-80834CNNB-B8TT2x | S-80834CNMC-B8TT2x | S-80834CNUA-B8TT2x |
| 3.5 V±2.0 % | 0.175 V | S-80835CNNB-B8UT2x | S-80835CNMC-B8UT2x | S-80835CNUA-B8UT2x |
| 3.6 V±2.0 % | 0.180 V | S-80836CNNB-B8VT2x | S-80836CNMC-B8VT2x | S-80836CNUA-B8VT2x |
| 3.7 V±2.0 % | 0.185 V | S-80837CNNB-B8WT2x | S-80837CNMC-B8WT2x | S-80837CNUA-B8WT2x |
| 3.8 V±2.0 % | 0.190 V | S-80838CNNB-B8XT2x | S-80838CNMC-B8XT2x | S-80838CNUA-B8XT2x |
| 3.9 V±2.0 % | 0.195 V | S-80839CNNB-B8YT2x | S-80839CNMC-B8YT2x | S-80839CNUA-B8YT2x |

Table 1 (2/2)

| Detection voltage range | Hysteresis width (Typ.) | SC-82AB | SOT-23-5 | SOT-89-3 |
|-------------------------|-------------------------|--------------------|--------------------|----------------------------------|
| 4.0 V±2.0 % | 0.200 V | S-80840CNNB-B8ZT2x | S-80840CNMC-B8ZT2x | S-80840CNUA-B8ZT2x |
| 4.1 V±2.0 % | 0.205 V | S-80841CNNB-B82T2x | S-80841CNMC-B82T2x | S-80841CNUA-B82T2x |
| 4.2 V±2.0 % | 0.210 V | S-80842CNNB-B83T2x | S-80842CNMC-B83T2x | S-80842CNUA-B83T2x |
| 4.3 V±2.0 % | 0.215 V | S-80843CNNB-B84T2x | S-80843CNMC-B84T2x | S-80843CNUA-B84T2x |
| 4.4 V±2.0 % | 0.220 V | S-80844CNNB-B85T2x | S-80844CNMC-B85T2x | S-80844CNUA-B85T2x |
| 4.5 V±2.0 % | 0.225 V | S-80845CNNB-B86T2x | S-80845CNMC-B86T2x | S-80845CNUA-B86T2x |
| 4.6 V±2.0 % | 0.230 V | S-80846CNNB-B87T2x | S-80846CNMC-B87T2x | S-80846CNUA-B87T2x |
| 4.6 V±0.10 V | 0.10 V max. | — | — | S-80846KNUA-D2CT2x ^{*3} |
| 4.7 V±2.0 % | 0.235 V | S-80847CNNB-B88T2x | S-80847CNMC-B88T2x | S-80847CNUA-B88T2x |
| 4.8 V±2.0 % | 0.240 V | S-80848CNNB-B89T2x | S-80848CNMC-B89T2x | S-80848CNUA-B89T2x |
| 4.9 V±2.0 % | 0.245 V | S-80849CNNB-B9AT2x | S-80849CNMC-B9AT2x | S-80849CNUA-B9AT2x |
| 5.0 V±2.0 % | 0.250 V | S-80850CNNB-B9BT2x | S-80850CNMC-B9BT2x | S-80850CNUA-B9BT2x |
| 5.1 V±2.0 % | 0.255 V | S-80851CNNB-B9CT2x | S-80851CNMC-B9CT2x | S-80851CNUA-B9CT2x |
| 5.2 V±2.0 % | 0.260 V | S-80852CNNB-B9DT2x | S-80852CNMC-B9DT2x | S-80852CNUA-B9DT2x |
| 5.3 V±2.0 % | 0.265 V | S-80853CNNB-B9ET2x | S-80853CNMC-B9ET2x | S-80853CNUA-B9ET2x |
| 5.4 V±2.0 % | 0.270 V | S-80854CNNB-B9FT2x | S-80854CNMC-B9FT2x | S-80854CNUA-B9FT2x |
| 5.5 V±2.0 % | 0.275 V | S-80855CNNB-B9GT2x | S-80855CNMC-B9GT2x | S-80855CNUA-B9GT2x |
| 5.6 V±2.0 % | 0.280 V | S-80856CNNB-B9HT2x | S-80856CNMC-B9HT2x | S-80856CNUA-B9HT2x |
| 5.7 V±2.0 % | 0.285 V | S-80857CNNB-B9IT2x | S-80857CNMC-B9IT2x | S-80857CNUA-B9IT2x |
| 5.8 V±2.0 % | 0.290 V | S-80858CNNB-B9JT2x | S-80858CNMC-B9JT2x | S-80858CNUA-B9JT2x |
| 5.9 V±2.0 % | 0.295 V | S-80859CNNB-B9KT2x | S-80859CNMC-B9KT2x | S-80859CNUA-B9KT2x |
| 6.0 V±2.0 % | 0.300 V | S-80860CNNB-B9LT2x | S-80860CNMC-B9LT2x | S-80860CNUA-B9LT2x |

*1. Describes the release voltage.

*2. Refer to the **Table 18** in “■ Electrical Characteristics for Customized Products” for electrical characteristics.

*3. Refer to the **Table 20** in “■ Electrical Characteristics for Customized Products” for electrical characteristics

Remark 1. x: G or U

2. Please select products of environmental code = U for Sn 100%, halogen-free products.

Table 2 (1/2)

| Detection voltage range | Hysteresis width (Typ.) | SNT-4A | TO-92*1 |
|-------------------------|-------------------------|---------------------|-------------------|
| 0.8 V±2.0 % | 0.034 V | S-80808CNPFB-B9MTFU | — |
| 0.9 V±2.0 % | 0.044 V | S-80809CNPFB-B9NTFU | — |
| 1.0 V±2.0 % | 0.054 V | S-80810CNPFB-B9OTFU | — |
| 1.1 V±2.0 % | 0.064 V | S-80811CNPFB-B9PTFU | — |
| 1.2 V±2.0 % | 0.073 V | S-80812CNPFB-B9QTFU | — |
| 1.3 V±2.0 % | 0.083 V | S-80813CNPFB-B9RTFU | — |
| 1.4 V±2.0 % | 0.093 V | S-80814CNPFB-B9STFU | — |
| 1.5 V±2.0 % | 0.075 V | S-80815CNPFB-B8ATFU | S-80815CNY-n2-U |
| 1.6 V±2.0 % | 0.080 V | S-80816CNPFB-B8BTFU | S-80816CNY-n2-U |
| 1.7 V±2.0 % | 0.085 V | S-80817CNPFB-B8CTFU | S-80817CNY-n2-U |
| 1.8 V±2.0 % | 0.090 V | S-80818CNPFB-B8DTFU | S-80818CNY-n2-U |
| 1.9 V±2.0 % | 0.095 V | S-80819CNPFB-B8ETFU | S-80819CNY-n2-U |
| 2.0 V±2.0 % | 0.100 V | S-80820CNPFB-B8FTFU | S-80820CNY-n2-U |
| 2.1 V±2.0 % | 0.105 V | S-80821CNPFB-B8GTFU | S-80821CNY-n2-U |
| 2.2 V±2.0 % | 0.110 V | S-80822CNPFB-B8HTFU | S-80822CNY-n2-U |
| 2.3 V±2.0 % | 0.115 V | S-80823CNPFB-B8ITFU | S-80823CNY-n2-U |
| 2.4 V±2.0 % | 0.120 V | S-80824CNPFB-B8JTFU | S-80824CNY-n2-U |
| 2.4 V typ. | 4.4 ± 0.1 V*2 | — | S-80824KNY-n2-U*3 |
| 2.5 V±2.0 % | 0.125 V | S-80825CNPFB-B8KTFU | S-80825CNY-n2-U |
| 2.6 V±2.0 % | 0.130 V | S-80826CNPFB-B8LTFU | S-80826CNY-n2-U |
| 2.7 V±2.0 % | 0.135 V | S-80827CNPFB-B8MTFU | S-80827CNY-n2-U |
| 2.8 V±2.0 % | 0.140 V | S-80828CNPFB-B8NTFU | S-80828CNY-n2-U |
| 2.9 V±2.0 % | 0.145 V | S-80829CNPFB-B8OTFU | S-80829CNY-n2-U |
| 3.0 V±2.0 % | 0.150 V | S-80830CNPFB-B8PTFU | S-80830CNY-n2-U |
| 3.1 V±2.0 % | 0.155 V | S-80831CNPFB-B8QTFU | S-80831CNY-n2-U |
| 3.2 V±2.0 % | 0.160 V | S-80832CNPFB-B8RTFU | S-80832CNY-n2-U |
| 3.3 V±2.0 % | 0.165 V | S-80833CNPFB-B8STFU | S-80833CNY-n2-U |
| 3.4 V±2.0 % | 0.170 V | S-80834CNPFB-B8TTFU | S-80834CNY-n2-U |
| 3.5 V±2.0 % | 0.175 V | S-80835CNPFB-B8UTFU | S-80835CNY-n2-U |
| 3.6 V±2.0 % | 0.180 V | S-80836CNPFB-B8VTFU | S-80836CNY-n2-U |
| 3.7 V±2.0 % | 0.185 V | S-80837CNPFB-B8WTFU | S-80837CNY-n2-U |
| 3.8 V±2.0 % | 0.190 V | S-80838CNPFB-B8XTFU | S-80838CNY-n2-U |
| 3.9 V±2.0 % | 0.195 V | S-80839CNPFB-B8YTFU | S-80839CNY-n2-U |
| 4.0 V±2.0 % | 0.200 V | S-80840CNPFB-B8ZTFU | S-80840CNY-n2-U |
| 4.1 V±2.0 % | 0.205 V | S-80841CNPFB-B82TFU | S-80841CNY-n2-U |
| 4.2 V±2.0 % | 0.210 V | S-80842CNPFB-B83TFU | S-80842CNY-n2-U |
| 4.3 V±2.0 % | 0.215 V | S-80843CNPFB-B84TFU | S-80843CNY-n2-U |
| 4.4 V±2.0 % | 0.220 V | S-80844CNPFB-B85TFU | S-80844CNY-n2-U |
| 4.5 V±2.0 % | 0.225 V | S-80845CNPFB-B86TFU | S-80845CNY-n2-U |
| 4.6 V±2.0 % | 0.230 V | S-80846CNPFB-B87TFU | S-80846CNY-n2-U |
| 4.6 V±0.10 V | 0.10 V max. | — | S-80846KNY-n2-U*4 |
| 4.7 V±2.0 % | 0.235 V | S-80847CNPFB-B88TFU | S-80847CNY-n2-U |
| 4.8 V±2.0 % | 0.240 V | S-80848CNPFB-B89TFU | S-80848CNY-n2-U |
| 4.9 V±2.0 % | 0.245 V | S-80849CNPFB-B9ATFU | S-80849CNY-n2-U |
| 5.0 V±2.0 % | 0.250 V | S-80850CNPFB-B9BTFU | S-80850CNY-n2-U |
| 5.1 V±2.0 % | 0.255 V | S-80851CNPFB-B9CTFU | S-80851CNY-n2-U |

Table 2 (2/2)

| Detection voltage range | Hysteresis width (Typ.) | SNT-4A | TO-92*1 |
|-------------------------|-------------------------|--------------------|-----------------|
| 5.2 V±2.0 % | 0.260 V | S-80852CNPF-B9DTFU | S-80852CNY-n2-U |
| 5.3 V±2.0 % | 0.265 V | S-80853CNPF-B9ETFU | S-80853CNY-n2-U |
| 5.4 V±2.0 % | 0.270 V | S-80854CNPF-B9FTFU | S-80854CNY-n2-U |
| 5.5 V±2.0 % | 0.275 V | S-80855CNPF-B9GTFU | S-80855CNY-n2-U |
| 5.6 V±2.0 % | 0.280 V | S-80856CNPF-B9HTFU | S-80856CNY-n2-U |
| 5.7 V±2.0 % | 0.285 V | S-80857CNPF-B9ITFU | S-80857CNY-n2-U |
| 5.8 V±2.0 % | 0.290 V | S-80858CNPF-B9JTFU | S-80858CNY-n2-U |
| 5.9 V±2.0 % | 0.295 V | S-80859CNPF-B9KTFU | S-80859CNY-n2-U |
| 6.0 V±2.0 % | 0.300 V | S-80860CNPF-B9LTFU | S-80860CNY-n2-U |

*1. n changes according to the packing form in TO-92. B: Bulk, Z: Tape and ammo

*2. Describes the release voltage.

*3. Refer to the **Table 18** in “■ Electrical Characteristics for Customized Products” for electrical characteristics.

*4. Refer to the **Table 20** in “■ Electrical Characteristics for Customized Products” for electrical characteristics.

SUPER-SMALL PACKAGE HIGH-PRECISION VOLTAGE DETECTOR

Rev.6.2_02

S-808xxC Series

3-2. CMOS Output Products

Table 3 (1/2)

| Detection voltage range | Hysteresis width (Typ.) | SC-82AB | SOT-23-5 | SOT-89-3 |
|-------------------------|-------------------------|--------------------|--------------------|----------------------|
| 0.8 V±2.0 % | 0.034 V | S-80808CLNB-B7MT2x | — | — |
| 0.9 V±2.0 % | 0.044 V | S-80809CLNB-B7NT2x | — | — |
| 1.0 V±2.0 % | 0.054 V | S-80810CLNB-B7OT2x | — | — |
| 1.1 V±2.0 % | 0.064 V | S-80811CLNB-B7PT2x | — | — |
| 1.2 V±2.0 % | 0.073 V | S-80812CLNB-B7QT2x | — | — |
| 1.3 V±2.0 % | 0.083 V | S-80813CLNB-B7RT2x | — | — |
| 1.4 V±2.0 % | 0.093 V | S-80814CLNB-B7ST2x | — | — |
| 1.5 V±2.0 % | 0.075 V | S-80815CLNB-B6AT2x | S-80815CLMC-B6AT2x | S-80815CLUA-B6AT2x |
| 1.6 V±2.0 % | 0.080 V | S-80816CLNB-B6BT2x | S-80816CLMC-B6BT2x | S-80816CLUA-B6BT2x |
| 1.7 V±2.0 % | 0.085 V | S-80817CLNB-B6CT2x | S-80817CLMC-B6CT2x | S-80817CLUA-B6CT2x |
| 1.8 V±2.0 % | 0.090 V | S-80818CLNB-B6DT2x | S-80818CLMC-B6DT2x | S-80818CLUA-B6DT2x |
| 1.9 V±2.0 % | 0.095 V | S-80819CLNB-B6ET2x | S-80819CLMC-B6ET2x | S-80819CLUA-B6ET2x |
| 2.0 V±2.0 % | 0.100 V | S-80820CLNB-B6FT2x | S-80820CLMC-B6FT2x | S-80820CLUA-B6FT2x |
| 2.1 V±2.0 % | 0.105 V | S-80821CLNB-B6GT2x | S-80821CLMC-B6GT2x | S-80821CLUA-B6GT2x |
| 2.2 V±2.0 % | 0.110 V | S-80822CLNB-B6HT2x | S-80822CLMC-B6HT2x | S-80822CLUA-B6HT2x |
| 2.3 V±2.0 % | 0.115 V | S-80823CLNB-B6IT2x | S-80823CLMC-B6IT2x | S-80823CLUA-B6IT2x |
| 2.4 V±2.0 % | 0.120 V | S-80824CLNB-B6JT2x | S-80824CLMC-B6JT2x | S-80824CLUA-B6JT2x |
| 2.5 V±2.0 % | 0.125 V | S-80825CLNB-B6KT2x | S-80825CLMC-B6KT2x | S-80825CLUA-B6KT2x |
| 2.6 V±2.0 % | 0.130 V | S-80826CLNB-B6LT2x | S-80826CLMC-B6LT2x | S-80826CLUA-B6LT2x |
| 2.7 V±2.0 % | 0.135 V | S-80827CLNB-B6MT2x | S-80827CLMC-B6MT2x | S-80827CLUA-B6MT2x |
| 2.8 V±2.0 % | 0.140 V | S-80828CLNB-B6NT2x | S-80828CLMC-B6NT2x | S-80828CLUA-B6NT2x |
| 2.9 V±2.0 % | 0.145 V | S-80829CLNB-B6OT2x | S-80829CLMC-B6OT2x | S-80829CLUA-B6OT2x |
| 3.0 V±2.0 % | 0.150 V | S-80830CLNB-B6PT2x | S-80830CLMC-B6PT2x | S-80830CLUA-B6PT2x |
| 3.1 V±2.0 % | 0.155 V | S-80831CLNB-B6QT2x | S-80831CLMC-B6QT2x | S-80831CLUA-B6QT2x |
| 3.2 V±2.0 % | 0.160 V | S-80832CLNB-B6RT2x | S-80832CLMC-B6RT2x | S-80832CLUA-B6RT2x |
| 3.3 V±2.0 % | 0.165 V | S-80833CLNB-B6ST2x | S-80833CLMC-B6ST2x | S-80833CLUA-B6ST2x |
| 3.4 V±2.0 % | 0.170 V | S-80834CLNB-B6TT2x | S-80834CLMC-B6TT2x | S-80834CLUA-B6TT2x |
| 3.5 V±2.0 % | 0.175 V | S-80835CLNB-B6UT2x | S-80835CLMC-B6UT2x | S-80835CLUA-B6UT2x |
| 3.6 V±2.0 % | 0.180 V | S-80836CLNB-B6VT2x | S-80836CLMC-B6VT2x | S-80836CLUA-B6VT2x |
| 3.7 V±2.0 % | 0.185 V | S-80837CLNB-B6WT2x | S-80837CLMC-B6WT2x | S-80837CLUA-B6WT2x |
| 3.8 V±2.0 % | 0.190 V | S-80838CLNB-B6XT2x | S-80838CLMC-B6XT2x | S-80838CLUA-B6XT2x |
| 3.9 V±2.0 % | 0.195 V | S-80839CLNB-B6YT2x | S-80839CLMC-B6YT2x | S-80839CLUA-B6YT2x |
| 4.0 V±2.0 % | 0.200 V | S-80840CLNB-B6ZT2x | S-80840CLMC-B6ZT2x | S-80840CLUA-B6ZT2x |
| 4.1 V±2.0 % | 0.205 V | S-80841CLNB-B62T2x | S-80841CLMC-B62T2x | S-80841CLUA-B62T2x |
| 4.2 V±2.0 % | 0.210 V | S-80842CLNB-B63T2x | S-80842CLMC-B63T2x | S-80842CLUA-B63T2x |
| 4.3 V±2.0 % | 0.215 V | S-80843CLNB-B64T2x | S-80843CLMC-B64T2x | S-80843CLUA-B64T2x |
| 4.4 V±2.0 % | 0.220 V | S-80844CLNB-B65T2x | S-80844CLMC-B65T2x | S-80844CLUA-B65T2x |
| 4.45 V typ. | 4.70 V max.*1 | — | — | S-80844KLUA-D2AT2x*2 |
| 4.5 V±2.0 % | 0.225 V | S-80845CLNB-B66T2x | S-80845CLMC-B66T2x | S-80845CLUA-B66T2x |
| 4.6 V±2.0 % | 0.230 V | S-80846CLNB-B67T2x | S-80846CLMC-B67T2x | S-80846CLUA-B67T2x |
| 4.7 V±2.0 % | 0.235 V | S-80847CLNB-B68T2x | S-80847CLMC-B68T2x | S-80847CLUA-B68T2x |
| 4.8 V±2.0 % | 0.240 V | S-80848CLNB-B69T2x | S-80848CLMC-B69T2x | S-80848CLUA-B69T2x |
| 4.9 V±2.0 % | 0.245 V | S-80849CLNB-B7AT2x | S-80849CLMC-B7AT2x | S-80849CLUA-B7AT2x |
| 5.0 V±2.0 % | 0.250 V | S-80850CLNB-B7BT2x | S-80850CLMC-B7BT2x | S-80850CLUA-B7BT2x |
| 5.1 V±2.0 % | 0.255 V | S-80851CLNB-B7CT2x | S-80851CLMC-B7CT2x | S-80851CLUA-B7CT2x |

Table 3 (2/2)

| Detection voltage range | Hysteresis width (Typ.) | SC-82AB | SOT-23-5 | SOT-89-3 |
|-------------------------|-------------------------|--------------------|--------------------|--------------------|
| 5.2 V±2.0 % | 0.260 V | S-80852CLNB-B7DT2x | S-80852CLMC-B7DT2x | S-80852CLUA-B7DT2x |
| 5.3 V±2.0 % | 0.265 V | S-80853CLNB-B7ET2x | S-80853CLMC-B7ET2x | S-80853CLUA-B7ET2x |
| 5.4 V±2.0 % | 0.270 V | S-80854CLNB-B7FT2x | S-80854CLMC-B7FT2x | S-80854CLUA-B7FT2x |
| 5.5 V±2.0 % | 0.275 V | S-80855CLNB-B7GT2x | S-80855CLMC-B7GT2x | S-80855CLUA-B7GT2x |
| 5.6 V±2.0 % | 0.280 V | S-80856CLNB-B7HT2x | S-80856CLMC-B7HT2x | S-80856CLUA-B7HT2x |
| 5.7 V±2.0 % | 0.285 V | S-80857CLNB-B7IT2x | S-80857CLMC-B7IT2x | S-80857CLUA-B7IT2x |
| 5.8 V±2.0 % | 0.290 V | S-80858CLNB-B7JT2x | S-80858CLMC-B7JT2x | S-80858CLUA-B7JT2x |
| 5.9 V±2.0 % | 0.295 V | S-80859CLNB-B7KT2x | S-80859CLMC-B7KT2x | S-80859CLUA-B7KT2x |
| 6.0 V±2.0 % | 0.300 V | S-80860CLNB-B7LT2x | S-80860CLMC-B7LT2x | S-80860CLUA-B7LT2x |

*1. Describes the release voltage.

*2. Refer to the **Table 19** in “■ Electrical Characteristics for Customized Products” for electrical characteristics.

Remark 1. x: G or U

2. Please select products of environmental code = U for Sn 100%, halogen-free products.

Table 4 (1/2)

| Detection voltage range | Hysteresis width (Typ.) | SNT-4A | TO-92*1 |
|-------------------------|-------------------------|--------------------|-----------------|
| 0.8 V±2.0 % | 0.034 V | S-80808CLPF-B7MTFU | — |
| 0.9 V±2.0 % | 0.044 V | S-80809CLPF-B7NTFU | — |
| 1.0 V±2.0 % | 0.054 V | S-80810CLPF-B7OTFU | — |
| 1.1 V±2.0 % | 0.064 V | S-80811CLPF-B7PTFU | — |
| 1.2 V±2.0 % | 0.073 V | S-80812CLPF-B7QTFU | — |
| 1.3 V±2.0 % | 0.083 V | S-80813CLPF-B7RTFU | — |
| 1.4 V±2.0 % | 0.093 V | S-80814CLPF-B7STFU | — |
| 1.5 V±2.0 % | 0.075 V | S-80815CLPF-B6ATFU | S-80815CLY-n2-U |
| 1.6 V±2.0 % | 0.080 V | S-80816CLPF-B6BTFU | S-80816CLY-n2-U |
| 1.7 V±2.0 % | 0.085 V | S-80817CLPF-B6CTFU | S-80817CLY-n2-U |
| 1.8 V±2.0 % | 0.090 V | S-80818CLPF-B6DTFU | S-80818CLY-n2-U |
| 1.9 V±2.0 % | 0.095 V | S-80819CLPF-B6ETFU | S-80819CLY-n2-U |
| 2.0 V±2.0 % | 0.100 V | S-80820CLPF-B6FTFU | S-80820CLY-n2-U |
| 2.1 V±2.0 % | 0.105 V | S-80821CLPF-B6GTFU | S-80821CLY-n2-U |
| 2.2 V±2.0 % | 0.110 V | S-80822CLPF-B6HTFU | S-80822CLY-n2-U |
| 2.3 V±2.0 % | 0.115 V | S-80823CLPF-B6ITFU | S-80823CLY-n2-U |
| 2.4 V±2.0 % | 0.120 V | S-80824CLPF-B6JTFU | S-80824CLY-n2-U |
| 2.5 V±2.0 % | 0.125 V | S-80825CLPF-B6KTFU | S-80825CLY-n2-U |
| 2.6 V±2.0 % | 0.130 V | S-80826CLPF-B6LTFU | S-80826CLY-n2-U |
| 2.7 V±2.0 % | 0.135 V | S-80827CLPF-B6MTFU | S-80827CLY-n2-U |
| 2.8 V±2.0 % | 0.140 V | S-80828CLPF-B6NTFU | S-80828CLY-n2-U |
| 2.9 V±2.0 % | 0.145 V | S-80829CLPF-B6OTFU | S-80829CLY-n2-U |
| 3.0 V±2.0 % | 0.150 V | S-80830CLPF-B6PTFU | S-80830CLY-n2-U |
| 3.1 V±2.0 % | 0.155 V | S-80831CLPF-B6QTFU | S-80831CLY-n2-U |
| 3.2 V±2.0 % | 0.160 V | S-80832CLPF-B6RTFU | S-80832CLY-n2-U |
| 3.3 V±2.0 % | 0.165 V | S-80833CLPF-B6STFU | S-80833CLY-n2-U |
| 3.4 V±2.0 % | 0.170 V | S-80834CLPF-B6TTFU | S-80834CLY-n2-U |
| 3.5 V±2.0 % | 0.175 V | S-80835CLPF-B6UTFU | S-80835CLY-n2-U |
| 3.6 V±2.0 % | 0.180 V | S-80836CLPF-B6VTFU | S-80836CLY-n2-U |
| 3.7 V±2.0 % | 0.185 V | S-80837CLPF-B6WTFU | S-80837CLY-n2-U |
| 3.8 V±2.0 % | 0.190 V | S-80838CLPF-B6XTFU | S-80838CLY-n2-U |

Table 4 (2/2)

| Detection voltage range | Hysteresis width (Typ.) | SNT-4A | TO-92*1 |
|-------------------------|---------------------------|--------------------|-------------------------------|
| 3.9 V±2.0 % | 0.195 V | S-80839CLPF-B6YTFU | S-80839CLY-n2-U |
| 4.0 V±2.0 % | 0.200 V | S-80840CLPF-B6ZTFU | S-80840CLY-n2-U |
| 4.1 V±2.0 % | 0.205 V | S-80841CLPF-B62TFU | S-80841CLY-n2-U |
| 4.2 V±2.0 % | 0.210 V | S-80842CLPF-B63TFU | S-80842CLY-n2-U |
| 4.3 V±2.0 % | 0.215 V | S-80843CLPF-B64TFU | S-80843CLY-n2-U |
| 4.4 V±2.0 % | 0.220 V | S-80844CLPF-B65TFU | S-80844CLY-n2-U |
| 4.45 V typ. | 4.70 V max. ^{*2} | — | S-80844KLY-n2-U ^{*3} |
| 4.5 V±2.0 % | 0.225 V | S-80845CLPF-B66TFU | S-80845CLY-n2-U |
| 4.6 V±2.0 % | 0.230 V | S-80846CLPF-B67TFU | S-80846CLY-n2-U |
| 4.7 V±2.0 % | 0.235 V | S-80847CLPF-B68TFU | S-80847CLY-n2-U |
| 4.8 V±2.0 % | 0.240 V | S-80848CLPF-B69TFU | S-80848CLY-n2-U |
| 4.9 V±2.0 % | 0.245 V | S-80849CLPF-B7ATFU | S-80849CLY-n2-U |
| 5.0 V±2.0 % | 0.250 V | S-80850CLPF-B7BTFU | S-80850CLY-n2-U |
| 5.1 V±2.0 % | 0.255 V | S-80851CLPF-B7CTFU | S-80851CLY-n2-U |
| 5.2 V±2.0 % | 0.260 V | S-80852CLPF-B7DTFU | S-80852CLY-n2-U |
| 5.3 V±2.0 % | 0.265 V | S-80853CLPF-B7ETFU | S-80853CLY-n2-U |
| 5.4 V±2.0 % | 0.270 V | S-80854CLPF-B7FTFU | S-80854CLY-n2-U |
| 5.5 V±2.0 % | 0.275 V | S-80855CLPF-B7GTFU | S-80855CLY-n2-U |
| 5.6 V±2.0 % | 0.280 V | S-80856CLPF-B7HTFU | S-80856CLY-n2-U |
| 5.7 V±2.0 % | 0.285 V | S-80857CLPF-B7ITFU | S-80857CLY-n2-U |
| 5.8 V±2.0 % | 0.290 V | S-80858CLPF-B7JTFU | S-80858CLY-n2-U |
| 5.9 V±2.0 % | 0.295 V | S-80859CLPF-B7KTFU | S-80859CLY-n2-U |
| 6.0 V±2.0 % | 0.300 V | S-80860CLPF-B7LTFU | S-80860CLY-n2-U |

*1. n changes according to the packing form in TO-92. B: Bulk, Z: Tape and ammo

*2. Describes the release voltage.

*3. Refer to the **Table 19** in “■ Electrical Characteristics for Customized Products” for electrical characteristics.

■ **Output Forms**

1. **Output Forms in S-808xxC Series**

Table 5

| | Nch open-drain output products (Active Low) | CMOS output products (Active Low) |
|-----------------|---|---|
| S-808xxC Series | “N” is the last letter of the product name. e.g. S-80815CN | “L” is the last letter of the product name. e.g. S-80815CL |

2. **Output Forms and Their Usage**

Table 6

| Usage | Nch open-drain output products (Active Low) | CMOS output products (Active Low) |
|--|--|--------------------------------------|
| Different power supplies | Yes | No |
| Active Low reset for CPUs | Yes | Yes |
| Active High reset for CPUs | No | No |
| Detection voltage change by resistor divider | Yes | No |

- Example for two power supplies
- Example for one power supply



Figure 3

■ **Pin Configurations**



Figure 4



Figure 5



Figure 6



Figure 7

Table 7

| Pin No. | Symbol | Description |
|---------|------------------|------------------------------|
| 1 | OUT | Voltage detection output pin |
| 2 | VDD | Voltage input pin |
| 3 | NC ^{*1} | No connection |
| 4 | VSS | GND pin |

*1. The NC pin is electrically open.
 The NC pin can be connected to VDD or VSS.

Table 8

| Pin No. | Symbol | Description |
|---------|------------------|------------------------------|
| 1 | OUT | Voltage detection output pin |
| 2 | VDD | Voltage input pin |
| 3 | VSS | GND pin |
| 4 | NC ^{*1} | No connection |
| 5 | NC ^{*1} | No connection |

*1. The NC pin is electrically open.
 The NC pin can be connected to VDD or VSS.

Table 9

| Pin No. | Symbol | Description |
|---------|--------|------------------------------|
| 1 | OUT | Voltage detection output pin |
| 2 | VDD | Voltage input pin |
| 3 | VSS | GND pin |

Table 10

| Pin No. | Symbol | Description |
|---------|------------------|------------------------------|
| 1 | OUT | Voltage detection output pin |
| 2 | VSS | GND pin |
| 3 | NC ^{*1} | No connection |
| 4 | VDD | Voltage input pin |

*1. The NC pin is electrically open.
 The NC pin can be connected to VDD or VSS.



Figure 8

Table 11

| Pin No. | Symbol | Description |
|---------|--------|------------------------------|
| 1 | OUT | Voltage detection output pin |
| 2 | VDD | Voltage input pin |
| 3 | VSS | GND pin |

■ **Absolute Maximum Ratings**

1. **Detection Voltage Typ. 1.4 V or Less Products**

Table 12

(Ta = 25 °C unless otherwise specified)

| Item | | Symbol | Absolute maximum ratings | Unit |
|-------------------------------|--------------------------------|-----------------|---------------------------------|------|
| Power supply voltage | | $V_{DD}-V_{SS}$ | 7 | V |
| Output voltage | Nch open-drain output products | V_{OUT} | $V_{SS}-0.3$ to $V_{SS}+7$ | V |
| | CMOS output products | | $V_{SS}-0.3$ to $V_{DD}+0.3$ | V |
| Output current | | I_{OUT} | 50 | mA |
| Power dissipation | SC-82AB | P_D | 150 (When not mounted on board) | mW |
| | | | 350 ^{*1} | mW |
| | SNT-4A | | 140 (When not mounted on board) | mW |
| | | | 300 ^{*1} | mW |
| Operating ambient temperature | | T_{opr} | -40 to +85 | °C |
| Storage temperature | | T_{stg} | -40 to +125 | °C |

*1. When mounted on board
 [Mounted board]

- (1) Board size: 114.3 mm × 76.2 mm × t1.6 mm
- (2) Board name: JEDEC STANDARD51-7

Caution The absolute maximum ratings are rated values exceeding which the product could suffer physical damage. These values must therefore not be exceeded under any conditions.



Figure 9 Power Dissipation of Package (When Mounted on Board)

2. Detection Voltage Typ. 1.5 V or More Products

Table 13

(Ta = 25 °C unless otherwise specified)

| Item | | Symbol | Absolute maximum ratings | Unit |
|-------------------------------|---------------------------------|-----------------|---------------------------------|------|
| Power supply voltage | | $V_{DD}-V_{SS}$ | 12 | V |
| Output voltage | Nch open-drain output products | V_{OUT} | $V_{SS}-0.3$ to $V_{SS}+12$ | V |
| | CMOS output products | | $V_{SS}-0.3$ to $V_{DD}+0.3$ | V |
| Output current | | I_{OUT} | 50 | mA |
| Power dissipation | SC-82AB | P_D | 150 (When not mounted on board) | mW |
| | | | 350 ^{*1} | mW |
| | SOT-23-5 | | 250 (When not mounted on board) | mW |
| | | | 600 ^{*1} | mW |
| | SOT-89-3 | | 500 (When not mounted on board) | mW |
| | | | 1000 ^{*1} | mW |
| | SNT-4A | | 140 (When not mounted on board) | mW |
| | | | 300 ^{*1} | mW |
| TO-92 | 400 (When not mounted on board) | mW | | |
| | 800 ^{*1} | mW | | |
| Operating ambient temperature | | T_{opr} | -40 to +85 | °C |
| Storage temperature | | T_{stg} | -40 to +125 | °C |

*1. When mounted on board

[Mounted board]

(1) Board size: 114.3 mm × 76.2 mm × t1.6 mm

(2) Board name: JEDEC STANDARD51-7

Caution The absolute maximum ratings are rated values exceeding which the product could suffer physical damage. These values must therefore not be exceeded under any conditions.

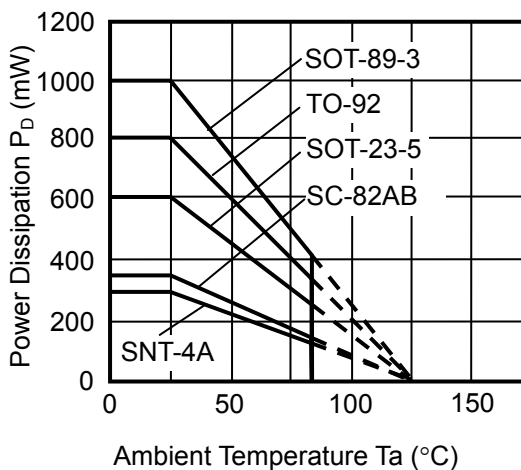

Figure 10 Power Dissipation of Package (When Mounted on Board)

■ Electrical Characteristics

1. Nch Open-drain Output Products

1-1. Detection Voltage Typ.1.4 V or Less Products

Table 14

(Ta = 25 °C unless otherwise specified)

| Item | Symbol | Condition | Min. | Typ. | Max. | Unit | Test circuit |
|---|---|--|---------------------------|---------------|---------------------------|--------------------------|--------------|
| Detection voltage*1 | $-V_{DET}$ | — | $-V_{DET(S)} \times 0.98$ | $-V_{DET(S)}$ | $-V_{DET(S)} \times 1.02$ | V | 1 |
| Release voltage | $+V_{DET}$ | S-80808 | 0.802 | 0.834 | 0.867 | V | 1 |
| | | S-80809 | 0.910 | 0.944 | 0.979 | V | 1 |
| | | S-80810 | 1.017 | 1.054 | 1.091 | V | 1 |
| | | S-80811 | 1.125 | 1.164 | 1.203 | V | 1 |
| | | S-80812 | 1.232 | 1.273 | 1.315 | V | 1 |
| | | S-80813 | 1.340 | 1.383 | 1.427 | V | 1 |
| | | S-80814 | 1.448 | 1.493 | 1.538 | V | 1 |
| Hysteresis width | V_{HYS} | S-80808 | 0.018 | 0.034 | 0.051 | V | 1 |
| | | S-80809 | 0.028 | 0.044 | 0.061 | V | 1 |
| | | S-80810 | 0.037 | 0.054 | 0.071 | V | 1 |
| | | S-80811 | 0.047 | 0.064 | 0.081 | V | 1 |
| | | S-80812 | 0.056 | 0.073 | 0.091 | V | 1 |
| | | S-80813 | 0.066 | 0.083 | 0.101 | V | 1 |
| | | S-80814 | 0.076 | 0.093 | 0.110 | V | 1 |
| Current consumption | I_{SS} | $V_{DD} = 1.5\text{ V}$ S-80808 to 09 | — | 1.3 | 3.5 | μA | 2 |
| | | $V_{DD} = 2.0\text{ V}$ S-80810 to 14 | — | 1.3 | 3.5 | μA | 2 |
| Operating voltage | V_{DD} | — | 0.65 | — | 5.0 | V | 1 |
| Output current | I_{OUT} | Output transistor, Nch, $V_{DS} = 0.5\text{ V}$, $V_{DD} = 0.7\text{ V}$ | 0.04 | 0.2 | — | mA | 3 |
| Leakage current | I_{LEAK} | Output transistor, Nch, $V_{DS} = 5.0\text{ V}$, $V_{DD} = 5.0\text{ V}$ | — | — | 60 | nA | 3 |
| Response time | t_{PLH} | — | — | — | 60 | μs | 1 |
| Detection voltage temperature coefficient*2 | $\frac{\Delta - V_{DET}}{\Delta Ta \bullet -V_{DET}}$ | $Ta = -40\text{ to }+85\text{ }^\circ\text{C}$ | — | ± 100 | ± 350 | ppm/ $^\circ\text{C}$ | 1 |

*1. $-V_{DET}$: Actual detection voltage value, $-V_{DET(S)}$: Specified detection voltage value (The center value of the detection voltage range in **Table 1 to 2**.)

*2. The temperature change of the detection voltage [mV/°C] is calculated by using the following equation.

$$\frac{\Delta - V_{DET}}{\Delta Ta} [\text{mV}/^\circ\text{C}]^{*1} = -V_{DET(S)}(\text{Typ.})[\text{V}]^{*2} \times \frac{\Delta - V_{DET}}{\Delta Ta \bullet -V_{DET}} [\text{ppm}/^\circ\text{C}]^{*3} \div 1000$$

*1. Temperature change of the detection voltage

*2. Specified detection voltage

*3. Detection voltage temperature coefficient

1-2. Detection Voltage Typ.1.5 V or More Products

Table 15

(Ta = 25 °C unless otherwise specified)

| Item | Symbol | Condition | Min. | Typ. | Max. | Unit | Test circuit | |
|---|---|---|--|----------------------------|-------------------------------|------------|--------------|---|
| Detection voltage* ¹ | -V _{DET} | — | -V _{DET(S)} ×0.98 | -V _{DET(S)} | -V _{DET(S)} ×1.02 | V | 1 | |
| Hysteresis width | V _{HYS} | — | -V _{DET} ×0.03 | -V _{DET} ×0.05 | -V _{DET} ×0.08 | V | 1 | |
| Current consumption | I _{SS} | V _{DD} = 3.5 V | S-80815 to 26 | — | 0.8 | 2.4 | μA | 2 |
| | | V _{DD} = 4.5 V | S-80827 to 39 | — | 0.8 | 2.4 | μA | 2 |
| | | V _{DD} = 6.0 V | S-80840 to 56 | — | 0.9 | 2.7 | μA | 2 |
| | | V _{DD} = 7.5 V | S-80857 to 60 | — | 0.9 | 2.7 | μA | 2 |
| Operating voltage | V _{DD} | — | 0.95 | — | 10.0 | V | 1 | |
| Output current | I _{OUT} | Output transistor, Nch, V _{DS} = 0.5 V | V _{DD} = 1.2 V S-80815 to 60 | 0.59 | 1.36 | — | mA | 3 |
| | | | V _{DD} = 2.4 V S-80827 to 60 | 2.88 | 4.98 | — | mA | 3 |
| Leakage current | I _{LEAK} | Output transistor, Nch, V _{DS} = 10.0 V, V _{DD} = 10.0 V | — | — | 100 | nA | 3 | |
| Response time | t _{PLH} | — | — | — | 60 | μs | 1 | |
| Detection voltage temperature coefficient* ² | $\frac{\Delta - V_{DET}}{\Delta Ta \bullet -V_{DET}}$ | Ta = -40 to +85 °C | — | ±100 | ±350 | ppm/ °C | 1 | |

*1. -V_{DET}: Actual detection voltage value, -V_{DET(S)}: Specified detection voltage value (The center value of the detection voltage range in **Table 1 to 2.**)

*2. The temperature change of the detection voltage [mV/°C] is calculated by using the following equation.

$$\frac{\Delta - V_{DET}}{\Delta Ta} [\text{mV}/^\circ\text{C}]^{*1} = -V_{DET(S)}(\text{Typ.})[\text{V}]^{*2} \times \frac{\Delta - V_{DET}}{\Delta Ta \bullet -V_{DET}} [\text{ppm}/^\circ\text{C}]^{*3} \div 1000$$

*1. Temperature change of the detection voltage

*2. Specified detection voltage

*3. Detection voltage temperature coefficient

SUPER-SMALL PACKAGE HIGH-PRECISION VOLTAGE DETECTOR
S-808xxC Series

Rev.6.2_02

2. CMOS Output Products

2-1. Detection Voltage Typ.1.4 V or Less Products

Table 16

(Ta = 25 °C unless otherwise specified)

| Item | Symbol | Condition | Min. | Typ. | Max. | Unit | Test circuit |
|---|---|---|---------------------------|---------------|---------------------------|---------------|--------------|
| Detection voltage*1 | $-V_{DET}$ | — | $-V_{DET(S)} \times 0.98$ | $-V_{DET(S)}$ | $-V_{DET(S)} \times 1.02$ | V | 1 |
| Release voltage | $+V_{DET}$ | S-80808 | 0.802 | 0.834 | 0.867 | V | 1 |
| | | S-80809 | 0.910 | 0.944 | 0.979 | V | 1 |
| | | S-80810 | 1.017 | 1.054 | 1.091 | V | 1 |
| | | S-80811 | 1.125 | 1.164 | 1.203 | V | 1 |
| | | S-80812 | 1.232 | 1.273 | 1.315 | V | 1 |
| | | S-80813 | 1.340 | 1.383 | 1.427 | V | 1 |
| | | S-80814 | 1.448 | 1.493 | 1.538 | V | 1 |
| Hysteresis width | V_{HYS} | S-80808 | 0.018 | 0.034 | 0.051 | V | 1 |
| | | S-80809 | 0.028 | 0.044 | 0.061 | V | 1 |
| | | S-80810 | 0.037 | 0.054 | 0.071 | V | 1 |
| | | S-80811 | 0.047 | 0.064 | 0.081 | V | 1 |
| | | S-80812 | 0.056 | 0.073 | 0.091 | V | 1 |
| | | S-80813 | 0.066 | 0.083 | 0.101 | V | 1 |
| | | S-80814 | 0.076 | 0.093 | 0.110 | V | 1 |
| Current consumption | I_{SS} | $V_{DD} = 1.5\text{ V}$ S-80808 to 09 | — | 1.3 | 3.5 | μA | 2 |
| | | $V_{DD} = 2.0\text{ V}$ S-80810 to 14 | — | 1.3 | 3.5 | μA | 2 |
| Operating voltage | V_{DD} | — | 0.65 | — | 5.0 | V | 1 |
| Output current | I_{OUT} | Output transistor, Nch, $V_{DS} = 0.5\text{ V}$, $V_{DD} = 0.7\text{ V}$ | 0.04 | 0.2 | — | mA | 3 |
| | | Output transistor, Pch, $V_{DS} = 2.1\text{ V}$, $V_{DD} = 4.5\text{ V}$ | 2.9 | 5.8 | — | mA | 4 |
| Response time | t_{PLH} | — | — | — | 60 | μs | 1 |
| Detection voltage temperature coefficient*2 | $\frac{\Delta - V_{DET}}{\Delta Ta \bullet -V_{DET}}$ | Ta = -40 to +85 °C | — | ± 100 | ± 350 | ppm/°C | 1 |

*1. $-V_{DET}$: Actual detection voltage value, $-V_{DET(S)}$: Specified detection voltage value (The center value of the detection voltage range in **Table 3 to 4**.)

*2. The temperature change of the detection voltage [mV/°C] is calculated by using the following equation.

$$\frac{\Delta - V_{DET}}{\Delta Ta} [\text{mV}/^\circ\text{C}]^{*1} = -V_{DET(S)}(\text{Typ.})[\text{V}]^{*2} \times \frac{\Delta - V_{DET}}{\Delta Ta \bullet -V_{DET}} [\text{ppm}/^\circ\text{C}]^{*3} \div 1000$$

*1. Temperature change of the detection voltage

*2. Specified detection voltage

*3. Detection voltage temperature coefficient

2-2. Detection Voltage Typ.1.5 V or More Products

Table 17

(Ta = 25 °C unless otherwise specified)

| Item | Symbol | Condition | Min. | Typ. | Max. | Unit | Test circuit | |
|---|---|--|--|----------------------------|-------------------------------|------------|--------------|---|
| Detection voltage* ¹ | -V _{DET} | — | -V _{DET(S)} ×0.98 | -V _{DET(S)} | -V _{DET(S)} ×1.02 | V | 1 | |
| Hysteresis width | V _{HYS} | — | -V _{DET} ×0.03 | -V _{DET} ×0.05 | -V _{DET} ×0.08 | V | 1 | |
| Current consumption | I _{SS} | V _{DD} = 3.5 V | S-80815 to 26 | — | 0.8 | 2.4 | μA | 2 |
| | | V _{DD} = 4.5 V | S-80827 to 39 | — | 0.8 | 2.4 | μA | 2 |
| | | V _{DD} = 6.0 V | S-80840 to 56 | — | 0.9 | 2.7 | μA | 2 |
| | | V _{DD} = 7.5 V | S-80857 to 60 | — | 0.9 | 2.7 | μA | 2 |
| Operating voltage | V _{DD} | — | 0.95 | — | 10.0 | V | 1 | |
| Output current | I _{OUT} | Output transistor, Nch, V _{DS} = 0.5 V | V _{DD} = 1.2 V S-80815 to 60 | 0.59 | 1.36 | — | mA | 3 |
| | | | V _{DD} = 2.4 V S-80827 to 60 | 2.88 | 4.98 | — | mA | 3 |
| | | Output transistor, Pch, V _{DS} = 0.5 V | V _{DD} = 4.8 V S-80815 to 39 | 1.43 | 2.39 | — | mA | 4 |
| | | | V _{DD} = 6.0 V S-80840 to 56 | 1.68 | 2.78 | — | mA | 4 |
| | | | V _{DD} = 8.4 V S-80857 to 60 | 2.08 | 3.42 | — | mA | 4 |
| Response time | t _{PLH} | — | — | — | 60 | μs | 1 | |
| Detection voltage temperature coefficient* ² | $\frac{\Delta - V_{DET}}{\Delta Ta \bullet -V_{DET}}$ | Ta = -40 to +85 °C | — | ±100 | ±350 | ppm/ °C | 1 | |

*1. -V_{DET}: Actual detection voltage value, -V_{DET(S)}: Specified detection voltage value (The center value of the detection voltage range in **Table 3 to 4.**)

*2. The temperature change of the detection voltage [mV/°C] is calculated by using the following equation.

$$\frac{\Delta - V_{DET}}{\Delta Ta} [\text{mV}/^{\circ}\text{C}]^{*1} = -V_{DET(S)}(\text{Typ.})[\text{V}]^{*2} \times \frac{\Delta - V_{DET}}{\Delta Ta \bullet -V_{DET}} [\text{ppm}/^{\circ}\text{C}]^{*3} \div 1000$$

*1. Temperature change of the detection voltage

*2. Specified detection voltage

*3. Detection voltage temperature coefficient

■ **Test Circuits**

1.



*1. R is unnecessary for CMOS output products.

Figure 11

2.



Figure 12

3.



Figure 13

4.



Figure 14

■ **Timing Chart**

1. Nch Open-drain Output Products



Figure 15

2. CMOS Output Products

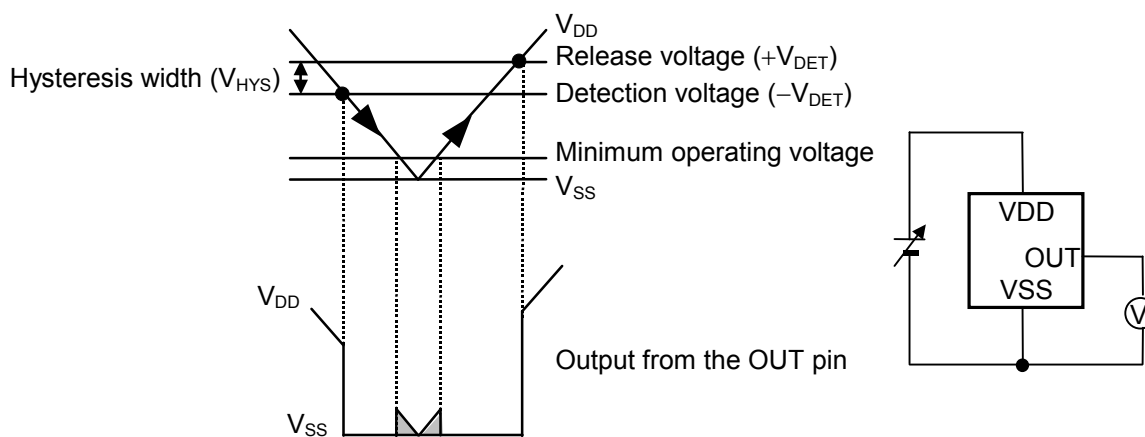

Remark For values of V_{DD} less than minimum operating voltage, values of OUT terminal output is free in the shaded region.

Figure 16

■ **Operation**

1. Basic Operation: CMOS Output (Active Low)

1-1. When the power supply voltage (V_{DD}) is higher than the release voltage ($+V_{DET}$), the Nch transistor is OFF and the Pch transistor is ON to provide V_{DD} (high) at the output. Since the Nch transistor N1 in

Figure 17 is OFF, the comparator input voltage is $\frac{(R_B + R_C) \cdot V_{DD}}{R_A + R_B + R_C}$.

1-2. When the V_{DD} goes below $+V_{DET}$, the output provides the V_{DD} level, as long as the V_{DD} remains above the detection voltage $-V_{DET}$. When the V_{DD} falls below $-V_{DET}$ (point A in **Figure 18**), the Nch transistor becomes ON, the Pch transistor becomes OFF, and the V_{SS} level appears at the output. At this time the Nch transistor N1 in **Figure 17** becomes ON, the comparator input voltage is changed to

$$\frac{R_B \cdot V_{DD}}{R_A + R_B}$$

1-3. When the V_{DD} falls below the minimum operating voltage, the output becomes undefined, or goes to the V_{DD} when the output is pulled up to the V_{DD} .

1-4. The V_{SS} level appears when the V_{DD} rises above the minimum operating voltage. The V_{SS} level still appears even when the V_{DD} surpasses $-V_{DET}$, as long as it does not exceed the release voltage $+V_{DET}$.

1-5. When the V_{DD} rises above $+V_{DET}$ (point B in **Figure 18**), the Nch transistor becomes OFF and the Pch transistor becomes ON to provide V_{DD} level at the output.



*1. Parasitic diode

Figure 17 Operation 1



Figure 18 Operation 2

2. Other Characteristics

2-1. Temperature Characteristics of Detection Voltage

The shaded area in **Figure 19** shows the temperature characteristics of the detection voltage.



*1. □ $-V_{DET25}$ is an actual detection voltage value at 25°C.

Figure 19 Temperature Characteristics of Detection Voltage (Example for S-80827C)

2-2. Temperature Characteristics of Release Voltage

The temperature change $\frac{\Delta + V_{DET}}{\Delta Ta}$ of the release voltage is calculated by using the temperature

change $\frac{\Delta - V_{DET}}{\Delta Ta}$ of the detection voltage as follows:

$$\frac{\Delta + V_{DET}}{\Delta Ta} = \frac{+V_{DET}}{-V_{DET}} \times \frac{\Delta - V_{DET}}{\Delta Ta}$$

The temperature change of the release voltage and the detection voltage have the same sign consequently.

2-3. Temperature Characteristics of Hysteresis Voltage

The temperature change of the hysteresis voltage is expressed as $\frac{\Delta + V_{DET}}{\Delta T_a} - \frac{\Delta - V_{DET}}{\Delta T_a}$ and is calculated

as follows:

$$\frac{\Delta + V_{DET}}{\Delta T_a} - \frac{\Delta - V_{DET}}{\Delta T_a} = \frac{V_{HYS}}{-V_{DET}} \times \frac{\Delta - V_{DET}}{\Delta T_a}$$

■ **Standard Circuit**



*1. R is unnecessary for CMOS output products.

Figure 20

Caution The above connection diagram and constants do not guarantee correct operation. Perform sufficient evaluation using the actual application to set the constants.

■ **Technical Terms**

1. Detection Voltage ($-V_{DET}$), Release Voltage ($+V_{DET}$)

The detection voltage ($-V_{DET}$) is a voltage at which the output turns to low. The detection voltage varies slightly among products of the same specification. The variation of detection voltage between the specified minimum ($-V_{DET}$) Min. and the maximum ($-V_{DET}$) Max. is called the detection voltage range (Refer to **Figure 21**).

Example: For the S-80815CN, the detection voltage lies in the range of $1.470 \leq (-V_{DET}) \leq 1.530$.
 This means that some S-80815CNs have 1.470 V for $-V_{DET}$ and some have 1.530 V.

The release voltage ($+V_{DET}$) is a voltage at which the output turns to high. The release voltage varies slightly among products of the same specification. The variation of release voltages between the specified minimum ($+V_{DET}$) Min. and the maximum ($+V_{DET}$) Max. is called the release voltage range (Refer to **Figure 22**). The range is calculated from the actual detection voltage ($-V_{DET}$) of a product and is expressed by $-V_{DET} \times 1.03 \leq +V_{DET} \leq -V_{DET} \times 1.08$.

Example: For the S-80815CN, the release voltage lies in the range of $1.514 \leq (+V_{DET}) \leq 1.652$.
 This means that some S-80815CNs have 1.514 V for $+V_{DET}$ and some have 1.652 V.



Figure 21 Detection Voltage (CMOS Output Products)



Figure 22 Release Voltage (CMOS Output Products)

Remark Although the detection voltage and release voltage overlap in the range of 1.514 V to 1.530 V, $+V_{DET}$ is always larger than $-V_{DET}$.

2. Hysteresis Width (V_{HYS})

The hysteresis width is the voltage difference between the detection voltage and the release voltage (The voltage at point B – The voltage at point A = V_{HYS} in **Figure 18**). The existence of the hysteresis width prevents malfunction caused by noise on input signal.

3. Through-type Current

The through-type current refers to the current that flows instantaneously at the time of detection and release of a voltage detector. The through-type current is large in CMOS output products, small in Nch open-drain output products.

4. Oscillation

In applications where a resistor is connected to the voltage detector input (**Figure 23**), taking a CMOS active low product for example, the through-type current which is generated when the output goes from low to high (release) causes a voltage drop equal to [through-type current] × [input resistance] across the resistor. When the input voltage drops below the detection voltage ($-V_{DET}$) as a result, the output voltage goes to low level. In this state, the through-type current stops and its resultant voltage drop disappears, and the output goes from low to high. A through-type current is again generated, a voltage drop appears, and repeating the process finally induces oscillation.



Figure 23 An Example for Bad Implementation of Input Voltage Divider

■ **Electrical Characteristics for Customized Products**

1. S-80824KNUA-D2BT2x, S-80824KNY-n2-U

Table 18

(Ta = 25 °C unless otherwise specified)

| Item | Symbol | Condition | Min. | Typ. | Max. | Unit | Test circuit |
|---|---|---|-------|-----------|-----------|-----------------------------|--------------|
| Detection voltage*1 | $-V_{DET}$ | — | 2.295 | 2.400*2 | 2.505 | V | 1 |
| Release voltage | $+V_{DET}$ | — | 4.300 | 4.400 | 4.500 | V | 1 |
| Current consumption | I_{SS} | $V_{DD}=6.0\text{ V}$ | — | 0.8 | 2.4 | μA | 2 |
| Operating voltage | V_{DD} | — | 0.95 | — | 10.0 | V | 1 |
| Output current | I_{OUT} | Output transistor, $V_{DD} = 0.95\text{ V}$ | 0.03 | 0.24 | — | mA | 3 |
| | | Nch, $V_{DS} = 0.5\text{ V}$ $V_{DD} = 1.2\text{ V}$ | 0.23 | 0.50 | — | mA | 3 |
| Leakage current | I_{LEAK} | Output transistor, Nch, $V_{DD} = 10.0\text{ V}$, $V_{DS} = 10.0\text{ V}$ | — | — | 0.1 | μA | 3 |
| Response time | t_{PLH} | — | — | — | 60 | μs | 1 |
| Detection voltage temperature coefficient*3 | $\frac{\Delta - V_{DET}}{\Delta Ta \bullet -V_{DET}}$ | $Ta = -40\text{ to }85\text{ }^\circ\text{C}$ | — | ± 100 | ± 350 | $\text{ppm}/^\circ\text{C}$ | 1 |

*1. $-V_{DET}$: Actual detection voltage value

*2. Specified detection voltage value ($-V_{DET(S)}$)

*3. The temperature change of the detection voltage [$\text{mV}/^\circ\text{C}$] is calculated by using the following equation.

$$\frac{\Delta - V_{DET}}{\Delta Ta} [\text{mV}/^\circ\text{C}]^*1 = -V_{DET(S)}(\text{Typ.})[\text{V}]^*2 \times \frac{\Delta - V_{DET}}{\Delta Ta \bullet -V_{DET}} [\text{ppm}/^\circ\text{C}]^*3 \div 1000$$

*1. Temperature change of the detection voltage

*2. Specified detection voltage

*3. Detection voltage temperature coefficient

2. S-80844KLUA-D2AT2x, S-80844KLY-n2-U

Table 19

(Ta = 25 °C unless otherwise specified)

| Item | Symbol | Condition | Min. | Typ. | Max. | Unit | Test circuit | |
|---|---|---|-------------------------|-----------|-----------|---------------|--------------|---|
| Detection voltage*1 | $-V_{DET}$ | — | 4.295 | 4.450*2 | 4.605 | V | 1 | |
| Release voltage | $+V_{DET}$ | — | — | — | 4.700 | V | 1 | |
| Current consumption | I_{SS} | $V_{DD} = 6.0\text{ V}$ | — | 1.0 | 3.0 | μA | 2 | |
| Operating voltage | V_{DD} | — | 0.95 | — | 10.0 | V | 1 | |
| Output current | I_{OUT} | Output transistor, Nch, $V_{DS} = 0.5\text{ V}$ | $V_{DD} = 1.2\text{ V}$ | 0.23 | 0.50 | — | mA | 3 |
| | | | $V_{DD} = 2.4\text{ V}$ | 1.60 | 3.70 | — | mA | 3 |
| | | Output transistor, Pch, $V_{DS} = 0.5\text{ V}$ | $V_{DD} = 4.8\text{ V}$ | 0.36 | 0.62 | — | mA | 4 |
| Response time | t_{PLH} | — | — | — | 60 | μs | 1 | |
| Detection voltage temperature coefficient*3 | $\frac{\Delta - V_{DET}}{\Delta Ta \bullet -V_{DET}}$ | $Ta = -40\text{ to }85\text{ }^\circ\text{C}$ | — | ± 100 | ± 350 | ppm/°C | 1 | |

*1. $-V_{DET}$: Actual detection voltage value

*2. Specified detection voltage value ($-V_{DET(S)}$)

*3. The temperature change of the detection voltage [mV/°C] is calculated by using the following equation.

$$\frac{\Delta - V_{DET}}{\Delta Ta} [\text{mV}/^\circ\text{C}]^{*1} = -V_{DET(S)}(\text{Typ.})[\text{V}]^{*2} \times \frac{\Delta - V_{DET}}{\Delta Ta \bullet -V_{DET}} [\text{ppm}/^\circ\text{C}]^{*3} \div 1000$$

*1. Temperature change of the detection voltage

*2. Specified detection voltage

*3. Detection voltage temperature coefficient

3. S-80846KNUA-D2CT2x, S-80846KNY-n2-U

Table 20

(Ta = 25 °C unless otherwise specified)

| Item | Symbol | Condition | Min. | Typ. | Max. | Unit | Test circuit |
|---|---|---|-------|-----------|-----------|---------------|--------------|
| Detection voltage*1 | $-V_{DET}$ | — | 4.500 | 4.600*2 | 4.700 | V | 1 |
| Hysteresis width | V_{HYS} | — | — | 0.05 | 0.10 | V | 1 |
| Current consumption | I_{SS} | $V_{DD} = 6.0\text{ V}$ | — | 0.9 | 2.7 | μA | 2 |
| Operating voltage | V_{DD} | — | 0.95 | — | 10.0 | V | 1 |
| Output current | I_{OUT} | Output transistor, $V_{DD} = 1.2\text{ V}$ | 0.59 | 1.36 | — | mA | 3 |
| | | Nch, $V_{DS} = 0.5\text{ V}$ | 2.88 | 4.98 | — | mA | 3 |
| Leakage current | I_{LEAK} | Output transistor, $V_{DD} = 10.0\text{ V}$ | — | — | 0.1 | μA | 3 |
| | | Nch, $V_{DS} = 10.0\text{ V}$ | — | — | 0.1 | μA | 3 |
| Response time | t_{PLH} | — | — | — | 60 | μs | 1 |
| Detection voltage temperature coefficient*3 | $\frac{\Delta - V_{DET}}{\Delta Ta \bullet -V_{DET}}$ | Ta = -40 to 85 °C | — | ± 100 | ± 350 | ppm/°C | 1 |

*1. $-V_{DET}$: Actual detection voltage value

*2. Specified detection voltage value ($-V_{DET(S)}$)

*3. The temperature change of the detection voltage [mV/°C] is calculated by using the following equation.

$$\frac{\Delta - V_{DET}}{\Delta Ta} [\text{mV}/^\circ\text{C}]^{*1} = -V_{DET(S)}(\text{Typ.})[\text{V}]^{*2} \times \frac{\Delta - V_{DET}}{\Delta Ta \bullet -V_{DET}} [\text{ppm}/^\circ\text{C}]^{*3} \div 1000$$

*1. Temperature change of the detection voltage

*2. Specified detection voltage

*3. Detection voltage temperature coefficient

■ Precautions

- Do not apply an electrostatic discharge to this IC that exceeds the performance ratings of the built-in electrostatic protection circuit.
- In CMOS output products of the S-808xxC series, the through-type current flows at the detection and the release. If the input impedance is high, oscillation may occur due to the voltage drop by the through-type current during releasing.
- In CMOS output products oscillation may occur when a pull-down resistor is used, and falling speed of the power supply voltage (V_{DD}) is slow near the detection voltage.
- When designing for mass production using an application circuit described herein, the product deviation and temperature characteristics should be taken into consideration. ABLIC Inc. shall not bear any responsibility for the products on the circuits described herein.
- ABLIC Inc. claims no responsibility for any and all disputes arising out of or in connection with any infringement of the products including this IC upon patents owned by a third party.

■ **Typical Characteristics (Typical Data)**

1. Detection Voltage (V_{DET}) - Temperature (T_a)



2. Hysteresis Voltage Width (V_{HYS}) - Temperature (T_a)



3. Current Consumption (I_{SS}) - Input Voltage (V_{DD})



4. Current Consumption (I_{SS}) - Temperature (T_a)

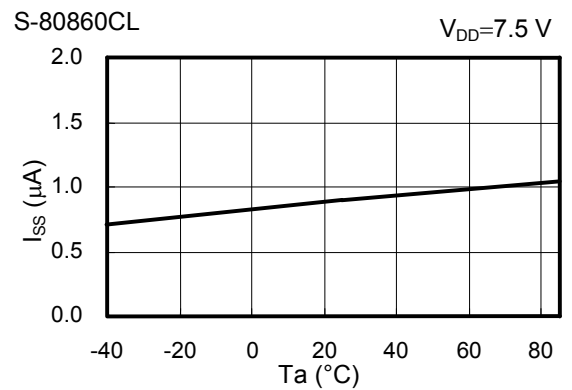
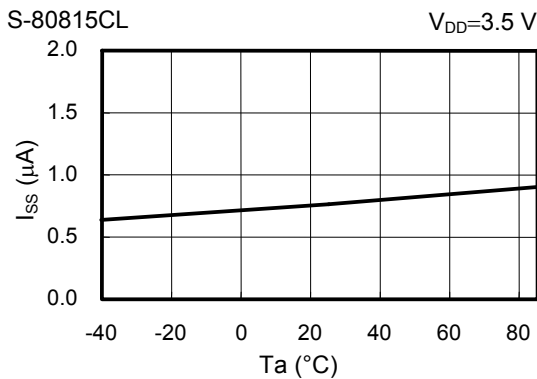

5. Nch Transistor Output Current (I_{OUT}) - V_{DS}



6. Pch Transistor Output Current (I_{OUT}) - V_{DS}

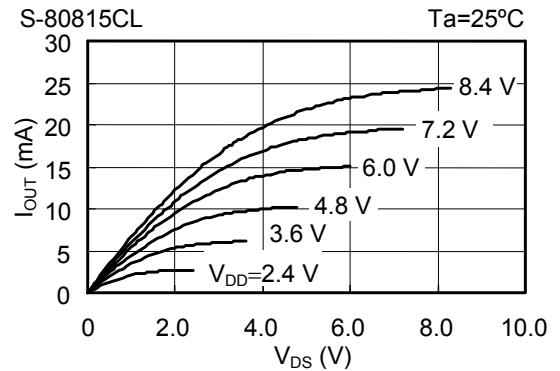

7. Nch Transistor Output Current (I_{OUT}) - Input Voltage (V_{DD})



8. Pch Transistor Output Current (I_{OUT}) - Input Voltage (V_{DD})



9. Minimum Operating Voltage - Input Voltage (V_{DD})

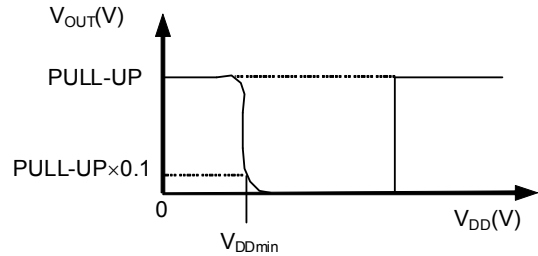
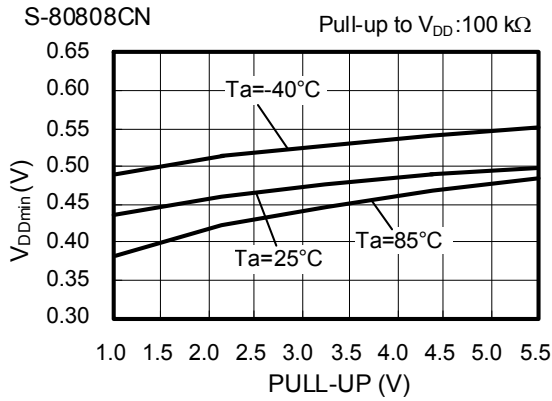
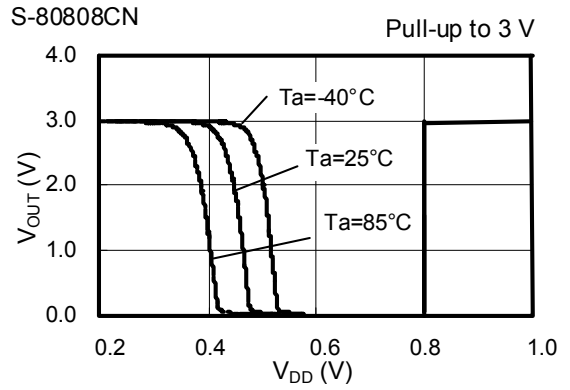
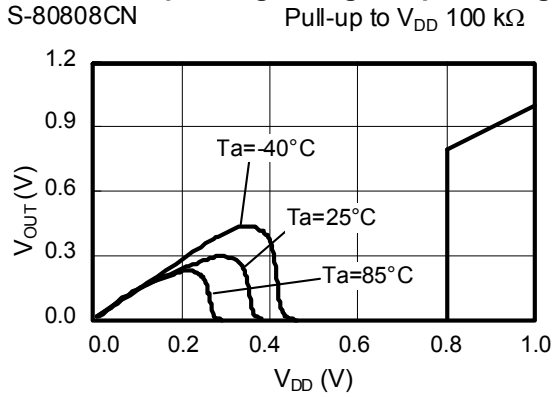

Remark V_{DDmin} is defined by the V_{DD} voltage at which V_{OUT} goes below 10% of PULL-UP voltage when the V_{DD} increase from 0 V.



Figure 24

10. Dynamic Response - C_{OUT}





Figure 25 Measurement Condition for Response Time



Figure 26 Measurement Circuit for Response Time
 *1. R is unnecessary for CMOS output products.

Caution The above connection diagram and constants do not guarantee correct operation. Perform sufficient evaluation using the actual application to set the constants.

■ **Application Circuit Examples**

1. Microcomputer Reset Circuits

If the power supply voltage to a microcomputer falls below the specified level, an unspecified operation may be performed or the contents of the memory register may be lost. When power supply voltage returns to normal, the microcomputer needs to be initialized before normal operations can be done. Reset circuits protect microcomputers in the event of current being momentarily switched off or lowered. Reset circuits shown in **Figures 27 to 28** can be easily constructed with the help of the S-808xxC series, that has low operating voltage, a high-precision detection voltage and hysteresis.

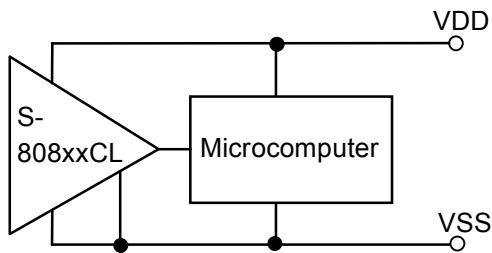
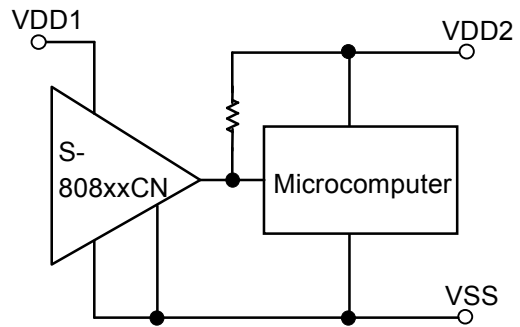

Figure 27 Reset Circuit Example(S-808xxCL)



(Only for Nch open-drain products)

Figure 28 Reset Circuit Example (S-808xxCN)

Caution The above connection diagram and constants do not guarantee correct operation. Perform sufficient evaluation using the actual application to set the constants.

2. Power-on Reset Circuit

A power-on reset circuit can be constructed using Nch open-drain output product of S-808xxC Series.



- *1. Resistor R should be 75 kΩ or less to prevent oscillation.
- *2. Diode Di instantaneously discharges the charge stored in the capacitor (C) at the power falling, Di can be removed when the delay of the falling time is not important.

Figure 29



Figure 30

Remark When the power rises sharply as shown in the **Figure 31** left, the output may goes to the high level for an instant in the undefined region where the output voltage is undefined since the power voltage is less than the minimum operation voltage.



Figure 31

3. Change of Detection Voltage

In Nch open-drain output products of the S-808xxC series, detection voltage can be changed using resistance dividers or diodes as shown in **Figures 32 to 33**. In **Figure 32**, hysteresis width also changes.



$$\text{Detection voltage} = \frac{R_A + R_B}{R_B} \cdot -V_{DET}$$

$$\text{Hysteresis width} = \frac{R_A + R_B}{R_B} \cdot V_{HYS}$$

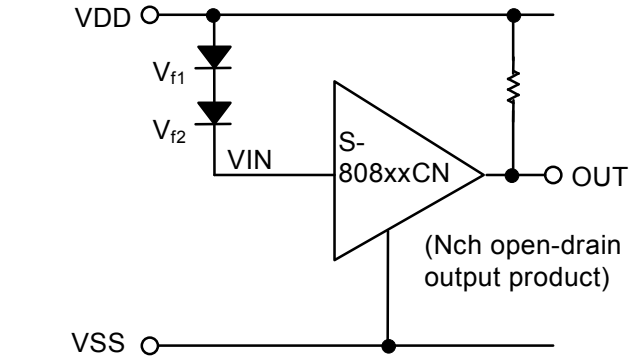

$$\text{Detection voltage} = V_{f1} + V_{f2} + (-V_{DET})$$

*1. R_A should be 75 kΩ or less to prevent oscillation.

Caution If R_A and R_B are large, the hysteresis width may also be larger than the value given by the above equation due to the through-type current (which flows slightly in an Nch open-drain product).

Figure 32

Figure 33

Caution The above connection diagram and constants do not guarantee correct operation. Perform sufficient evaluation using the actual application to set the constants.



No. NP004-A-P-SD-2.0

| | |
|-------------------|-------------------------|
| TITLE | SC82AB-A-PKG Dimensions |
| No. | NP004-A-P-SD-2.0 |
| ANGLE | |
| UNIT | mm |
| ABLIC Inc. | |



No. NP004-A-C-SD-3.0

| | |
|-------------------|-----------------------|
| TITLE | SC82AB-A-Carrier Tape |
| No. | NP004-A-C-SD-3.0 |
| ANGLE | |
| UNIT | mm |
| | |
| ABLIC Inc. | |

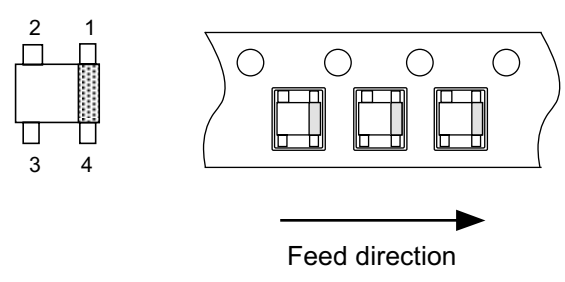

No. NP004-A-C-S1-2.0

| | |
|-------------------|-----------------------|
| TITLE | SC82AB-A-Carrier Tape |
| No. | NP004-A-C-S1-2.0 |
| ANGLE | |
| UNIT | mm |
| ABLIC Inc. | |



Enlarged drawing in the central part



No. NP004-A-R-SD-1.1

| | | | |
|-------------------|------------------|------|-------|
| TITLE | SC82AB-A-Reel | | |
| No. | NP004-A-R-SD-1.1 | | |
| ANGLE | | QTY. | 3,000 |
| UNIT | mm | | |
| | | | |
| ABLIC Inc. | | | |



No. MP005-A-P-SD-1.3

| | |
|-------------------|-------------------------|
| TITLE | SOT235-A-PKG Dimensions |
| No. | MP005-A-P-SD-1.3 |
| ANGLE | |
| UNIT | mm |
| ABLIC Inc. | |



→ Feed direction

No. MP005-A-C-SD-2.1

| | |
|-------------------|-----------------------|
| TITLE | SOT235-A-Carrier Tape |
| No. | MP005-A-C-SD-2.1 |
| ANGLE | |
| UNIT | mm |
| ABLIC Inc. | |



Enlarged drawing in the central part



No. MP005-A-R-SD-1.1

| | | | |
|-------------------|------------------|------|-------|
| TITLE | SOT235-A-Reel | | |
| No. | MP005-A-R-SD-1.1 | | |
| ANGLE | | QTY. | 3,000 |
| UNIT | mm | | |
| | | | |
| ABLIC Inc. | | | |



No. UP003-A-P-SD-2.0

| | |
|-------|-------------------------|
| TITLE | SOT893-A-PKG Dimensions |
| No. | UP003-A-P-SD-2.0 |
| ANGLE | |
| UNIT | mm |
| | |

ABLIC Inc.



→
Feed direction

No. UP003-A-C-SD-2.0

| | |
|-------------------|-----------------------|
| TITLE | SOT893-A-Carrier Tape |
| No. | UP003-A-C-SD-2.0 |
| ANGLE | |
| UNIT | mm |
| | |
| ABLIC Inc. | |



Enlarged drawing in the central part



No. UP003-A-R-SD-1.1

| | | | |
|-------------------|------------------|------|-------|
| TITLE | SOT893-A-Reel | | |
| No. | UP003-A-R-SD-1.1 | | |
| ANGLE | | QTY. | 1,000 |
| UNIT | mm | | |
| | | | |
| ABLIC Inc. | | | |



No. PF004-A-P-SD-6.0

| | |
|-------------------|-------------------------|
| TITLE | SNT-4A-A-PKG Dimensions |
| No. | PF004-A-P-SD-6.0 |
| ANGLE | |
| UNIT | mm |
| ABLIC Inc. | |



Feed direction →

No. PF004-A-C-SD-2.0

| | |
|-------------------|-----------------------|
| TITLE | SNT-4A-A-Carrier Tape |
| No. | PF004-A-C-SD-2.0 |
| ANGLE | |
| UNIT | mm |
| | |
| ABLIC Inc. | |



Enlarged drawing in the central part



No. PF004-A-R-SD-1.0

| | | | |
|-------------------|------------------|------|-------|
| TITLE | SNT-4A-A-Reel | | |
| No. | PF004-A-R-SD-1.0 | | |
| ANGLE | | QTY. | 5,000 |
| UNIT | mm | | |
| | | | |
| ABLIC Inc. | | | |



※1. ランドパターンの幅に注意してください (0.25 mm min. / 0.30 mm typ.).

※2. パッケージ中央にランドパターンを広げないでください (1.10 mm ~ 1.20 mm)。

- 注意
1. パッケージのモールド樹脂下にシルク印刷やハンダ印刷などしないでください。
 2. パッケージ下の配線上のソルダーレジストなどの厚みをランドパターン表面から0.03 mm 以下にしてください。
 3. マスク開口サイズと開口位置はランドパターンと合わせてください。
 4. 詳細は "SNTパッケージ活用の手引き" を参照してください。

※1. Pay attention to the land pattern width (0.25 mm min. / 0.30 mm typ.).

※2. Do not widen the land pattern to the center of the package (1.10 mm to 1.20 mm).

- Caution**
1. Do not do silkscreen printing and solder printing under the mold resin of the package.
 2. The thickness of the solder resist on the wire pattern under the package should be 0.03 mm or less from the land pattern surface.
 3. Match the mask aperture size and aperture position with the land pattern.
 4. Refer to "SNT Package User's Guide" for details.

※1. 请注意焊盘模式的宽度 (0.25 mm min. / 0.30 mm typ.).

※2. 请勿向封装中间扩展焊盘模式 (1.10 mm ~ 1.20 mm)。

- 注意
1. 请勿在树脂型封装的下面印刷丝网、焊锡。
 2. 在封装下、布线上的阻焊膜厚度 (从焊盘模式表面起) 请控制在 0.03 mm 以下。
 3. 钢网的开口尺寸和开口位置请与焊盘模式对齐。
 4. 详细内容请参阅 "SNT 封装的应用指南"。

No. PF004-A-L-SD-4.1

| | |
|-------------------|----------------------------------|
| TITLE | SNT-4A-A -Land Recommendation |
| No. | PF004-A-L-SD-4.1 |
| ANGLE | |
| UNIT | mm |
| ABLIC Inc. | |



No. YS003-D-P-SD-2.1

| | |
|------------|-----------------------|
| TITLE | TO92-D-PKG Dimensions |
| No. | YS003-D-P-SD-2.1 |
| ANGLE | |
| UNIT | mm |
| ABLIC Inc. | |



No. YZ003-E-P-SD-2.1

| | |
|-------------------|-----------------------|
| TITLE | TO92-E-PKG Dimensions |
| No. | YZ003-E-P-SD-2.1 |
| ANGLE | |
| UNIT | mm |
| ABLIC Inc. | |



Z type



Feed direction

No. YZ003-E-C-SD-1.1

| | |
|-------------------|--------------------|
| TITLE | TO92-E-Radial Tape |
| No. | YZ003-E-C-SD-1.1 |
| ANGLE | |
| UNIT | mm |
| ABLIC Inc. | |



Side spacer placed in front side



Space more than 4 strokes



No. YZ003-E-Z-SD-2.0

| | | | |
|-------------------|---------------------|------|-------|
| TITLE | TO92-E-Ammo Packing | | |
| No. | YZ003-E-Z-SD-2.0 | | |
| ANGLE | | QTY. | 2,000 |
| UNIT | mm | | |
| | | | |
| ABLIC Inc. | | | |

Disclaimers (Handling Precautions)

1. All the information described herein (product data, specifications, figures, tables, programs, algorithms and application circuit examples, etc.) is current as of publishing date of this document and is subject to change without notice.
2. The circuit examples and the usages described herein are for reference only, and do not guarantee the success of any specific mass-production design.
ABLIC Inc. is not liable for any losses, damages, claims or demands caused by the reasons other than the products described herein (hereinafter "the products") or infringement of third-party intellectual property right and any other right due to the use of the information described herein.
3. ABLIC Inc. is not liable for any losses, damages, claims or demands caused by the incorrect information described herein.
4. Be careful to use the products within their ranges described herein. Pay special attention for use to the absolute maximum ratings, operation voltage range and electrical characteristics, etc.
ABLIC Inc. is not liable for any losses, damages, claims or demands caused by failures and / or accidents, etc. due to the use of the products outside their specified ranges.
5. Before using the products, confirm their applications, and the laws and regulations of the region or country where they are used and verify suitability, safety and other factors for the intended use.
6. When exporting the products, comply with the Foreign Exchange and Foreign Trade Act and all other export-related laws, and follow the required procedures.
7. The products are strictly prohibited from using, providing or exporting for the purposes of the development of weapons of mass destruction or military use. ABLIC Inc. is not liable for any losses, damages, claims or demands caused by any provision or export to the person or entity who intends to develop, manufacture, use or store nuclear, biological or chemical weapons or missiles, or use any other military purposes.
8. The products are not designed to be used as part of any device or equipment that may affect the human body, human life, or assets (such as medical equipment, disaster prevention systems, security systems, combustion control systems, infrastructure control systems, vehicle equipment, traffic systems, in-vehicle equipment, aviation equipment, aerospace equipment, and nuclear-related equipment), excluding when specified for in-vehicle use or other uses by ABLIC, Inc. Do not apply the products to the above listed devices and equipments.
ABLIC Inc. is not liable for any losses, damages, claims or demands caused by unauthorized or unspecified use of the products.
9. In general, semiconductor products may fail or malfunction with some probability. The user of the products should therefore take responsibility to give thorough consideration to safety design including redundancy, fire spread prevention measures, and malfunction prevention to prevent accidents causing injury or death, fires and social damage, etc. that may ensue from the products' failure or malfunction.
The entire system in which the products are used must be sufficiently evaluated and judged whether the products are allowed to apply for the system on customer's own responsibility.
10. The products are not designed to be radiation-proof. The necessary radiation measures should be taken in the product design by the customer depending on the intended use.
11. The products do not affect human health under normal use. However, they contain chemical substances and heavy metals and should therefore not be put in the mouth. The fracture surfaces of wafers and chips may be sharp. Be careful when handling these with the bare hands to prevent injuries, etc.
12. When disposing of the products, comply with the laws and ordinances of the country or region where they are used.
13. The information described herein contains copyright information and know-how of ABLIC Inc. The information described herein does not convey any license under any intellectual property rights or any other rights belonging to ABLIC Inc. or a third party. Reproduction or copying of the information from this document or any part of this document described herein for the purpose of disclosing it to a third-party is strictly prohibited without the express permission of ABLIC Inc.
14. For more details on the information described herein or any other questions, please contact ABLIC Inc.'s sales representative.
15. This Disclaimers have been delivered in a text using the Japanese language, which text, despite any translations into the English language and the Chinese language, shall be controlling.

2.4-2019.07