

Features

- ◆ 128K x 36, 256K x 18 memory configurations
- ◆ Supports fast access times:
 - Commercial:
 - 6.5ns up to 133MHz clock frequency (TQFP package only)
 - Commercial and Industrial:
 - 7.5ns up to 117MHz clock frequency
 - 8.0ns up to 100MHz clock frequency
 - 8.5ns up to 87MHz clock frequency
- ◆ $\overline{\text{LBO}}$ input selects interleaved or linear burst mode
- ◆ Self-timed write cycle with global write control ($\overline{\text{GW}}$), byte write enable ($\overline{\text{BWE}}$), and byte writes ($\overline{\text{BWx}}$)
- ◆ 3.3V core power supply
- ◆ Power down controlled by ZZ input
- ◆ 3.3V I/O
- ◆ Optional - Boundary Scan JTAG Interface (IEEE 1149.1 compliant)
- ◆ Packaged in a JEDEC Standard 100-pin plastic thin quad flatpack (TQFP), 119 ball grid array (BGA) and 165 fine pitch ball grid array

Description

The IDT71V3577/79 are high-speed SRAMs organized as 128K x 36/256K x 18. The IDT71V3577/79 SRAMs contain write, data, address and control registers. There are no registers in the data output path (flow-through architecture). Internal logic allows the SRAM to generate a self-timed write based upon a decision which can be left until the end of the write cycle.

The burst mode feature offers the highest level of performance to the system designer, as the IDT71V3577/79 can provide four cycles of data for a single address presented to the SRAM. An internal burst address counter accepts the first cycle address from the processor, initiating the access sequence. The first cycle of output data will flow-through from the array after a clock-to-data access time delay from the rising clock edge of the same cycle. If burst mode operation is selected ($\overline{\text{ADV}}=\text{LOW}$), the subsequent three cycles of output data will be available to the user on the next three rising clock edges. The order of these three addresses are defined by the internal burst counter and the $\overline{\text{LBO}}$ input pin.

The IDT71V3577/79 SRAMs utilize IDT's latest high-performance CMOS process and are packaged in a JEDEC standard 14mm x 20mm 100-pin thin plastic quad flatpack (TQFP) as well as a 119 ball grid array (BGA) and a 165 fine pitch ball grid array (fBGA).

Pin Description Summary

A0-A17	Address Inputs	Input	Synchronous
$\overline{\text{CE}}$	Chip Enable	Input	Synchronous
CS ₀ , $\overline{\text{CS}}_1$	Chip Selects	Input	Synchronous
$\overline{\text{OE}}$	Output Enable	Input	Asynchronous
$\overline{\text{GW}}$	Global Write Enable	Input	Synchronous
$\overline{\text{BWE}}$	Byte Write Enable	Input	Synchronous
$\overline{\text{BW}}_1$, $\overline{\text{BW}}_2$, $\overline{\text{BW}}_3$, $\overline{\text{BW}}_4^{(1)}$	Individual Byte Write Selects	Input	Synchronous
CLK	Clock	Input	N/A
$\overline{\text{ADV}}$	Burst Address Advance	Input	Synchronous
$\overline{\text{ADSC}}$	Address Status (Cache Controller)	Input	Synchronous
$\overline{\text{ADSP}}$	Address Status (Processor)	Input	Synchronous
$\overline{\text{LBO}}$	Linear / Interleaved Burst Order	Input	DC
TMS	Test Mode Select	Input	Synchronous
TDI	Test Data Input	Input	Synchronous
TCK	Test Clock	Input	N/A
TDO	Test Data Output	Output	Synchronous
$\overline{\text{TRST}}$	JTAG Reset (Optional)	Input	Asynchronous
ZZ	Sleep Mode	Input	Asynchronous
I/O ₀ -I/O ₃₁ , I/OP ₁ -I/OP ₄	Data Input / Output	I/O	Synchronous
V _{DD} , V _{DDQ}	Core Power, I/O Power	Supply	N/A
V _{SS}	Ground	Supply	N/A

NOTE:

1. $\overline{\text{BW}}_3$ and $\overline{\text{BW}}_4$ are not applicable for the IDT71V3579.

Pin Definitions⁽¹⁾

Symbol	Pin Function	I/O	Active	Description
A0-A17	Address Inputs	I	N/A	Synchronous Address inputs. The address register is triggered by a combination of the rising edge of CLK and \overline{ADSC} Low or \overline{ADSP} Low and \overline{CE} Low.
\overline{ADSC}	Address Status (Cache Controller)	I	LOW	Synchronous Address Status from Cache Controller. \overline{ADSC} is an active LOW input that is used to load the address registers with new addresses.
\overline{ADSP}	Address Status (Processor)	I	LOW	Synchronous Address Status from Processor. \overline{ADSP} is an active LOW input that is used to load the address registers with new addresses. \overline{ADSP} is gated by \overline{CE} .
\overline{ADV}	Burst Address Advance	I	LOW	Synchronous Address Advance. \overline{ADV} is an active LOW input that is used to advance the internal burst counter, controlling burst access after the initial address is loaded. When the input is HIGH the burst counter is not incremented; that is, there is no address advance.
\overline{BWE}	Byte Write Enable	I	LOW	Synchronous byte write enable gates the byte write inputs $\overline{BW1}$ - $\overline{BW4}$. If \overline{BWE} is LOW at the rising edge of CLK then \overline{BWx} inputs are passed to the next stage in the circuit. If \overline{BWE} is HIGH then the byte write inputs are blocked and only \overline{GW} can initiate a write cycle.
$\overline{BW1}$ - $\overline{BW4}$	Individual Byte Write Enables	I	LOW	Synchronous byte write enables. $\overline{BW1}$ controls I/O0-7, I/OP1, $\overline{BW2}$ controls I/O8-15, I/OP2, etc. Any active byte write causes all outputs to be disabled.
\overline{CE}	Chip Enable	I	LOW	Synchronous chip enable. \overline{CE} is used with CS_0 and \overline{CS}_1 to enable the IDT71V3577/79. \overline{CE} also gates \overline{ADSP} .
CLK	Clock	I	N/A	This is the clock input. All timing references for the device are made with respect to this input.
CS_0	Chip Select 0	I	HIGH	Synchronous active HIGH chip select. CS_0 is used with \overline{CE} and \overline{CS}_1 to enable the chip.
\overline{CS}_1	Chip Select 1	I	LOW	Synchronous active LOW chip select. \overline{CS}_1 is used with \overline{CE} and CS_0 to enable the chip.
\overline{GW}	Global Write Enable	I	LOW	Synchronous global write enable. This input will write all four 9-bit data bytes when LOW on the rising edge of CLK. \overline{GW} supersedes individual byte write enables.
I/O0-I/O31 I/OP1-I/OP4	Data Input/Output	I/O	N/A	Synchronous data input/output (I/O) pins. The data input path is registered, triggered by the rising edge of CLK. The data output path is flow-through (no output register).
\overline{LBO}	Linear Burst Order	I	LOW	Asynchronous burst order selection input. When \overline{LBO} is HIGH, the inter-leaved burst sequence is selected. When \overline{LBO} is LOW the Linear burst sequence is selected. \overline{LBO} is a static input and must not change state while the device is operating.
\overline{OE}	Output Enable	I	LOW	Asynchronous output enable. When \overline{OE} is LOW the data output drivers are enabled on the I/O pins if the chip is also selected. When \overline{OE} is HIGH the I/O pins are in a high-impedance state.
TMS	Test ModeSelect	I	N/A	Gives input command for TAP controller. Sampled on rising edge of TDK. This pin has an internal pullup.
TDI	Test Data Input	I	N/A	Serial input of registers placed between TDI and TDO. Sampled on rising edge of TCK. This pin has an internal pullup.
TCK	Test Clock	I	N/A	Clock input of TAP controller. Each TAP event is clocked. Test inputs are captured on rising edge of TCK, while test outputs are driven from the falling edge of TCK. This pin has an internal pullup.
TDO	Test DataOutput	O	N/A	Serial output of registers placed between TDI and TDO. This output is active depending on the state of the TAP controller.
\overline{TRST}	JTAG Reset (Optional)	I	LOW	Optional Asynchronous JTAG reset. Can be used to reset the TAP controller, but not required. JTAG reset occurs automatically at power up and also resets using TMS and TCK per IEEE 1149.1. If not used \overline{TRST} can be left floating. This pin has an internal pullup. Only available in BGA package.
ZZ	Sleep Mode	I	HIGH	Asynchronous sleep mode input. ZZ HIGH will gate the CLK internally and power down the IDT71V3577/79 to its lowest power consumption level. Data retention is guaranteed in Sleep Mode. This pin has an internal pull down.
VDD	Power Supply	N/A	N/A	3.3V core power supply.
VDDO	Power Supply	N/A	N/A	3.3V I/O Supply.
VSS	Ground	N/A	N/A	Ground.
NC	No Connect	N/A	N/A	NC pins are not electrically connected to the device.

6450 tbl 02

NOTE:

1. All synchronous inputs must meet specified setup and hold times with respect to CLK.

Functional Block Diagram



Absolute Maximum Ratings⁽¹⁾

Symbol	Rating	Commercial & Industrial Values	Unit
V _{TERM} ⁽²⁾	Terminal Voltage with Respect to GND	-0.5 to +4.6	V
V _{TERM} ^(3,6)	Terminal Voltage with Respect to GND	-0.5 to V _{DD}	V
V _{TERM} ^(4,6)	Terminal Voltage with Respect to GND	-0.5 to V _{DD} +0.5	V
V _{TERM} ^(5,6)	Terminal Voltage with Respect to GND	-0.5 to V _{DDQ} +0.5	V
T _A ⁽⁷⁾	Commercial Operating Temperature	-0 to +70	°C
	Industrial Operating Temperature	-40 to +85	°C
T _{BIAS}	Temperature Under Bias	-55 to +125	°C
T _{STG}	Storage Temperature	-55 to +125	°C
P _T	Power Dissipation	2.0	W
I _{OUT}	DC Output Current	50	mA

6450 tbl 03

NOTES:

- Stresses greater than those listed under ABSOLUTE MAXIMUM RATINGS may cause permanent damage to the device. This is a stress rating only and functional operation of the device at these or any other conditions above those indicated in the operational sections of this specification is not implied. Exposure to absolute maximum rating conditions for extended periods may affect reliability.
- V_{DD} terminals only.
- V_{DDQ} terminals only.
- Input terminals only.
- I/O terminals only.
- This is a steady-state DC parameter that applies after the power supplies have ramped up. Power supply sequencing is not necessary; however, the voltage on any input or I/O pin cannot exceed V_{DDQ} during power supply ramp up.
- T_A is the "instant on" case temperature.

Recommended Operating Temperature Supply Voltage

Grade	Temperature ⁽¹⁾	V _{SS}	V _{DD}	V _{DDQ}
Commercial	0°C to +70°C	0V	3.3V±5%	3.3V±5%
Industrial	-40°C to +85°C	0V	3.3V±5%	3.3V±5%

6450 tbl 04

NOTES:

- T_A is the "instant on" case temperature.

Recommended DC Operating Conditions

Symbol	Parameter	Min.	Typ.	Max.	Unit
V _{DD}	Core Supply Voltage	3.135	3.3	3.465	V
V _{DDQ}	I/O Supply Voltage	3.135	3.3	3.465	V
V _{SS}	Supply Voltage	0	0	0	V
V _{IH}	Input High Voltage - Inputs	2.0	—	V _{DD} +0.3	V
V _{IH}	Input High Voltage - I/O	2.0	—	V _{DDQ} +0.3 ⁽¹⁾	V
V _{IL}	Input Low Voltage	-0.3 ⁽²⁾	—	0.8	V

6450 tbl 06

NOTES:

- V_{IH} (max) = V_{DDQ} + 1.0V for pulse width less than t_{CVCI/2}, once per cycle.
- V_{IL} (min) = -1.0V for pulse width less than t_{CVCI/2}, once per cycle.

100 Pin TQFP Capacitance

(T_A = +25° C, f = 1.0mhz)

Symbol	Parameter ⁽¹⁾	Conditions	Max.	Unit
C _{IN}	Input Capacitance	V _{IN} = 3dV	5	pF
C _{IO}	I/O Capacitance	V _{OUT} = 3dV	7	pF

6450 tbl 07

119 BGA Capacitance

(T_A = +25° C, f = 1.0mhz)

Symbol	Parameter ⁽¹⁾	Conditions	Max.	Unit
C _{IN}	Input Capacitance	V _{IN} = 3dV	7	pF
C _{IO}	I/O Capacitance	V _{OUT} = 3dV	7	pF

6450 tbl 07a

165 fBGA Capacitance

(T_A = +25° C, f = 1.0mhz)

Symbol	Parameter ⁽¹⁾	Conditions	Max.	Unit
C _{IN}	Input Capacitance	V _{IN} = 3dV	7	pF
C _{IO}	I/O Capacitance	V _{OUT} = 3dV	7	pF

6450 tbl 07b

NOTE:

- This parameter is guaranteed by device characterization, but not production tested.

Pin Configuration – 128K x 36



100 TOFP Top View

NOTES:

1. Pin 14 does not have to be directly connected to Vss as long as the input voltage is $\leq V_{IL}$.
2. Pin 64 can be left unconnected and the device will always remain in active mode.

Pin Configuration – 256K x 18



100 TQFP Top View

NOTES:

1. Pin 14 does not have to be directly connected to Vss as long as the input voltage is $\leq V_{IL}$.
2. Pin 64 can be left unconnected and the device will always remain in active mode.

Pin Configuration – 128K x 36, 119 BGA

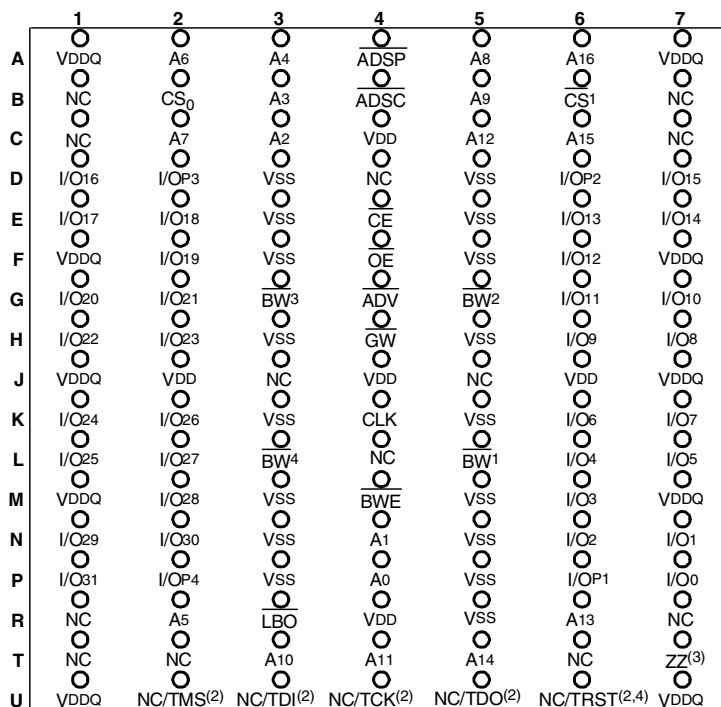

6450 drw 02c

Top View

Pin Configuration – 256K x 18, 119 BGA

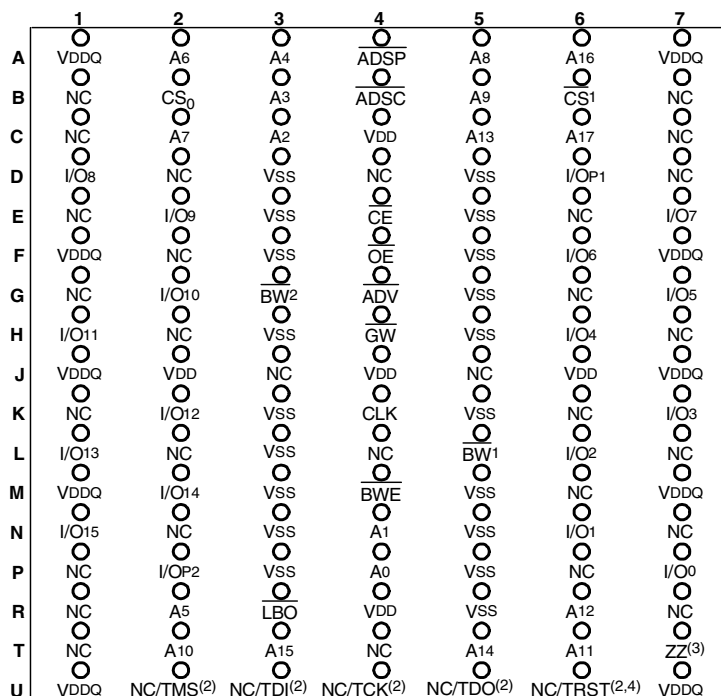

6450 drw 02d

Top View

NOTES:

1. R5 does not have to be directly connected to Vss as long as the input voltage is $\leq V_{IL}$.
2. These pins are NC for the "S" version or the JTAG signal listed for the "SA" version. Note: If NC, these pins can either be tied to Vss, Vdd or left floating.
3. T7 can be left unconnected and the device will always remain in active mode.
4. TRST is offered as an optional JTAG Reset if required in the application. If not needed, can be left floating and will internally be pulled to Vdd.

Pin Configuration – 128K x 36, 165 fBGA

	1	2	3	4	5	6	7	8	9	10	11
A	NC ⁽⁴⁾	A7	\overline{CE}_1	\overline{BW}_3	\overline{BW}_2	\overline{CS}_1	\overline{BWE}	\overline{ADSC}	\overline{ADV}	A8	NC
B	NC	A6	CS0	\overline{BW}_4	\overline{BW}_1	CLK	\overline{GW}	\overline{OE}	\overline{ADSP}	A9	NC ⁽⁴⁾
C	I/OP3	NC	VDDQ	VSS	VSS	VSS	VSS	VSS	VDDQ	NC	I/OP2
D	I/O17	I/O16	VDDQ	VDD	VSS	VSS	VSS	VDD	VDDQ	I/O15	I/O14
E	I/O19	I/O18	VDDQ	VDD	VSS	VSS	VSS	VDD	VDDQ	I/O13	I/O12
F	I/O21	I/O20	VDDQ	VDD	VSS	VSS	VSS	VDD	VDDQ	I/O11	I/O10
G	I/O23	I/O22	VDDQ	VDD	VSS	VSS	VSS	VDD	VDDQ	I/O9	I/O8
H	VSS ⁽¹⁾	NC	NC	VDD	VSS	VSS	VSS	VDD	NC	NC	ZZ ⁽³⁾
J	I/O25	I/O24	VDDQ	VDD	VSS	VSS	VSS	VDD	VDDQ	I/O7	I/O6
K	I/O27	I/O26	VDDQ	VDD	VSS	VSS	VSS	VDD	VDDQ	I/O5	I/O4
L	I/O29	I/O28	VDDQ	VDD	VSS	VSS	VSS	VDD	VDDQ	I/O3	I/O2
M	I/O31	I/O30	VDDQ	VDD	VSS	VSS	VSS	VDD	VDDQ	I/O1	I/O0
N	I/OP4	NC	VDDQ	VSS	NC/TRST ^(2,5)	NC ⁽⁴⁾	NC	VSS	VDDQ	NC	I/OP1
P	NC	NC ⁽⁴⁾	A5	A2	NC/TDI ⁽²⁾	A1	NC/TDO ⁽²⁾	A10	A13	A14	NC ⁽⁴⁾
R	\overline{LBO}	NC ⁽⁴⁾	A4	A3	NC/TMS ⁽²⁾	A0	NC/TCK ⁽²⁾	A11	A12	A15	A16

6450 tbl 17

Pin Configuration – 256K x 18, 165 fBGA

	1	2	3	4	5	6	7	8	9	10	11
A	NC ⁽⁴⁾	A7	\overline{CE}_1	\overline{BW}_2	NC	\overline{CS}_1	\overline{BWE}	\overline{ADSC}	\overline{ADV}	A8	A10
B	NC	A6	CS0	NC	\overline{BW}_1	CLK	\overline{GW}	\overline{OE}	\overline{ADSP}	A9	NC ⁽⁴⁾
C	NC	NC	VDDQ	VSS	VSS	VSS	VSS	VSS	VDDQ	NC	I/OP1
D	NC	I/O8	VDDQ	VDD	VSS	VSS	VSS	VDD	VDDQ	NC	I/O7
E	NC	I/O9	VDDQ	VDD	VSS	VSS	VSS	VDD	VDDQ	NC	I/O6
F	NC	I/O10	VDDQ	VDD	VSS	VSS	VSS	VDD	VDDQ	NC	I/O5
G	NC	I/O11	VDDQ	VDD	VSS	VSS	VSS	VDD	VDDQ	NC	I/O4
H	VSS ⁽¹⁾	NC	NC	VDD	VSS	VSS	VSS	VDD	NC	NC	ZZ ⁽³⁾
J	I/O12	NC	VDDQ	VDD	VSS	VSS	VSS	VDD	VDDQ	I/O3	NC
K	I/O13	NC	VDDQ	VDD	VSS	VSS	VSS	VDD	VDDQ	I/O2	NC
L	I/O14	NC	VDDQ	VDD	VSS	VSS	VSS	VDD	VDDQ	I/O1	NC
M	I/O15	NC	VDDQ	VDD	VSS	VSS	VSS	VDD	VDDQ	I/O0	NC
N	I/OP2	NC	VDDQ	VSS	NC/TRST ^(2,5)	NC ⁽⁴⁾	NC	VSS	VDDQ	NC	NC
P	NC	NC ⁽⁴⁾	A5	A2	NC/TDI ⁽²⁾	A1	NC/TDO ⁽²⁾	A11	A14	A15	NC ⁽⁴⁾
R	\overline{LBO}	NC ⁽⁴⁾	A4	A3	NC/TMS ⁽²⁾	A0	NC/TCK ⁽²⁾	A12	A13	A16	A17

6450 tbl 17a

NOTES:

- H1 does not have to be directly Vss as long as input voltage is $\leq V_{IL}$.
- These pins are NC for the "S" version or the JTAG signal listed for the "SA" version. Note: If NC, these pins can either be tied to Vss, VDD or left floating.
- H11 can be left unconnected and the device will always remain in active mode.
- Pins P11, N6, B11, A1, R2 and P2 are reserved for 9M, 18M, 36M, 72M, 144M and 288M respectively.
- TRST is offered as an optional JTAG Reset if required in the application. If not needed, can be left floating and will internally be pulled to VDD.

DC Electrical Characteristics Over the Operating Temperature and Supply Voltage Range ($V_{DD} = 3.3V \pm 5\%$)

Symbol	Parameter	Test Conditions	Min.	Max.	Unit
$ I_{L} $	Input Leakage Current	$V_{DD} = \text{Max.}, V_{IN} = 0V \text{ to } V_{DD}$	—	5	μA
$ I_{L} $	ZZ, \overline{LBO} and JTAG Input Leakage Current ⁽¹⁾	$V_{DD} = \text{Max.}, V_{IN} = 0V \text{ to } V_{DD}$	—	30	μA
$ I_{LO} $	Output Leakage Current	$V_{OUT} = 0V \text{ to } V_{DDQ}, \text{ Device Deselected}$	—	5	μA
V_{OL}	Output Low Voltage	$I_{OL} = +8mA, V_{DD} = \text{Min.}$	—	0.4	V
V_{OH}	Output High Voltage	$I_{OH} = -8mA, V_{DD} = \text{Min.}$	2.4	—	V

6450 tbl 08

NOTE:

- The \overline{LBO} , TMS, TDI, TCK and \overline{TRST} pins will be internally pulled to V_{DD} and the ZZ in will be internally pulled to V_{SS} if they are not actively driven in the application.

DC Electrical Characteristics Over the Operating Temperature and Supply Voltage Range ⁽¹⁾

Symbol	Parameter	Test Conditions	6.5ns		7.5ns		8ns		8.5ns		Unit
			Com'l Only	Com'l	Ind	Com'l	Ind	Com'l	Ind		
I_{DD}	Operating Power Supply Current	Device Selected, Outputs Open, $V_{DD} = \text{Max.}, V_{DDQ} = \text{Max.}, V_{IN} \geq V_{IH} \text{ or } \leq V_{IL}, f = f_{MAX}^{(2)}$	300	255	265	200	210	180	190	mA	
I_{SB1}	CMOS Standby Power Supply Current	Device Deselected, Outputs Open, $V_{DD} = \text{Max.}, V_{DDQ} = \text{Max.}, V_{IN} \geq V_{HD} \text{ or } \leq V_{LD}, f = 0^{(2,3)}$	30	30	35	30	35	30	35	mA	
I_{SB2}	Clock Running Power Supply Current	Device Deselected, Outputs Open, $V_{DD} = \text{Max.}, V_{DDQ} = \text{Max.}, V_{IN} \geq V_{HD} \text{ or } \leq V_{LD}, f = f_{MAX}^{(2,3)}$	110	90	100	85	95	80	90	mA	
I_{ZZ}	Full Sleep Mode Supply Current	$ZZ \geq V_{HD}, V_{DD} = \text{Max.}$	30	30	35	30	35	30	35	mA	

6450 tbl 09a

NOTES:

- All values are maximum guaranteed values.
- At $f = f_{MAX}$, inputs are cycling at the maximum frequency of read cycles of 1/t_{cy} while $\overline{ADSC} = \text{LOW}$; $f=0$ means no input lines are changing.
- For I/Os $V_{HD} = V_{DDQ} - 0.2V, V_{LD} = 0.2V$. For other inputs $V_{HD} = V_{DD} - 0.2V, V_{LD} = 0.2V$.

AC Test Conditions ($V_{DDQ} = 3.3V$)

Input Pulse Levels	0 to 3V
Input Rise/Fall Times	2ns
Input Timing Reference Levels	1.5V
Output Timing Reference Levels	1.5V
AC Test Load	See Figure 1

6450 tbl 10

AC Test Load

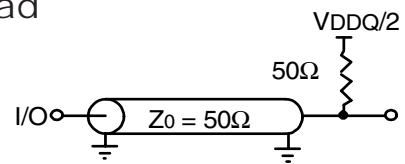

6450 drw 03

Figure 1. AC Test Load



6450 drw 05

Figure 2. Lumped Capacitive Load, Typical Derating

Synchronous Truth Table ^(1,3)

Operation	Address Used	\overline{CE}	CS ₀	\overline{CS}_1	\overline{ADSP}	\overline{ADSC}	\overline{ADV}	\overline{GW}	\overline{BWE}	\overline{BW}_x	$\overline{OE}^{(2)}$	CLK	I/O
Deselected Cycle, Power Down	None	H	X	X	X	L	X	X	X	X	X	↑	HI-Z
Deselected Cycle, Power Down	None	L	X	H	L	X	X	X	X	X	X	↑	HI-Z
Deselected Cycle, Power Down	None	L	L	X	L	X	X	X	X	X	X	↑	HI-Z
Deselected Cycle, Power Down	None	L	X	H	X	L	X	X	X	X	X	↑	HI-Z
Deselected Cycle, Power Down	None	L	L	X	X	L	X	X	X	X	X	↑	HI-Z
Read Cycle, Begin Burst	External	L	H	L	L	X	X	X	X	X	L	↑	DOUT
Read Cycle, Begin Burst	External	L	H	L	L	X	X	X	X	X	H	↑	HI-Z
Read Cycle, Begin Burst	External	L	H	L	H	L	X	H	H	X	L	↑	DOUT
Read Cycle, Begin Burst	External	L	H	L	H	L	X	H	L	H	L	↑	DOUT
Read Cycle, Begin Burst	External	L	H	L	H	L	X	H	L	H	H	↑	HI-Z
Write Cycle, Begin Burst	External	L	H	L	H	L	X	H	L	L	X	↑	DIN
Write Cycle, Begin Burst	External	L	H	L	H	L	X	L	X	X	X	↑	DIN
Read Cycle, Continue Burst	Next	X	X	X	H	H	L	H	H	X	L	↑	DOUT
Read Cycle, Continue Burst	Next	X	X	X	H	H	L	H	H	X	H	↑	HI-Z
Read Cycle, Continue Burst	Next	X	X	X	H	H	L	H	X	H	L	↑	DOUT
Read Cycle, Continue Burst	Next	X	X	X	H	H	L	H	X	H	H	↑	HI-Z
Read Cycle, Continue Burst	Next	H	X	X	X	H	L	H	H	X	L	↑	DOUT
Read Cycle, Continue Burst	Next	H	X	X	X	H	L	H	H	X	H	↑	HI-Z
Read Cycle, Continue Burst	Next	H	X	X	X	H	L	H	X	H	L	↑	DOUT
Read Cycle, Continue Burst	Next	H	X	X	X	H	L	H	X	H	H	↑	HI-Z
Write Cycle, Continue Burst	Next	X	X	X	H	H	L	H	L	L	X	↑	DIN
Write Cycle, Continue Burst	Next	X	X	X	H	H	L	L	X	X	X	↑	DIN
Write Cycle, Continue Burst	Next	H	X	X	X	H	L	H	L	L	X	↑	DIN
Write Cycle, Continue Burst	Next	H	X	X	X	H	L	L	X	X	X	↑	DIN
Read Cycle, Suspend Burst	Current	X	X	X	H	H	H	H	H	X	L	↑	DOUT
Read Cycle, Suspend Burst	Current	X	X	X	H	H	H	H	H	X	H	↑	HI-Z
Read Cycle, Suspend Burst	Current	X	X	X	H	H	H	H	X	H	L	↑	DOUT
Read Cycle, Suspend Burst	Current	X	X	X	H	H	H	H	X	H	H	↑	HI-Z
Read Cycle, Suspend Burst	Current	H	X	X	X	H	H	H	H	X	L	↑	DOUT
Read Cycle, Suspend Burst	Current	H	X	X	X	H	H	H	H	X	H	↑	HI-Z
Read Cycle, Suspend Burst	Current	H	X	X	X	H	H	H	X	H	L	↑	DOUT
Read Cycle, Suspend Burst	Current	H	X	X	X	H	H	H	X	H	H	↑	HI-Z
Write Cycle, Suspend Burst	Current	X	X	X	H	H	H	H	L	L	X	↑	DIN
Write Cycle, Suspend Burst	Current	X	X	X	H	H	H	L	X	X	X	↑	DIN
Write Cycle, Suspend Burst	Current	H	X	X	X	H	H	H	L	L	X	↑	DIN
Write Cycle, Suspend Burst	Current	H	X	X	X	H	H	L	X	X	X	↑	DIN

NOTES:

1. L = V_{IL}, H = V_{IH}, X = Don't Care.
2. \overline{OE} is an asynchronous input.
3. ZZ - low for the table.

6450 tbl 11

Synchronous Write Function Truth Table ^(1, 2)

Operation	\overline{GW}	BWE	BW ₁	\overline{BW}_2	\overline{BW}_3	\overline{BW}_4
Read	H	H	X	X	X	X
Read	H	L	H	H	H	H
Write all Bytes	L	X	X	X	X	X
Write all Bytes	H	L	L	L	L	L
Write Byte 1 ⁽³⁾	H	L	L	H	H	H
Write Byte 2 ⁽³⁾	H	L	H	L	H	H
Write Byte 3 ⁽³⁾	H	L	H	H	L	H
Write Byte 4 ⁽³⁾	H	L	H	H	H	L

6450 tbl 12

NOTES:

1. L = V_{IL}, H = V_{IH}, X = Don't Care.
2. \overline{BW}_3 and \overline{BW}_4 are not applicable for the IDT71V3579.
3. Multiple bytes may be selected during the same cycle.

Asynchronous Truth Table ⁽¹⁾

Operation ⁽²⁾	\overline{OE}	ZZ	I/O Status	Power
Read	L	L	Data Out	Active
Read	H	L	High-Z	Active
Write	X	L	High-Z - Data In	Active
Deselected	X	L	High-Z	Standby
Sleep Mode	X	H	High-Z	Sleep

6450 tbl 13

NOTES:

1. L = V_{IL}, H = V_{IH}, X = Don't Care.
2. Synchronous function pins must be biased appropriately to satisfy operation requirements.

Interleaved Burst Sequence Table ($\overline{LBO} = V_{DD}$)

	Sequence 1		Sequence 2		Sequence 3		Sequence 4	
	A1	A0	A1	A0	A1	A0	A1	A0
First Address	0	0	0	1	1	0	1	1
Second Address	0	1	0	0	1	1	1	0
Third Address	1	0	1	1	0	0	0	1
Fourth Address ⁽¹⁾	1	1	1	0	0	1	0	0

6450 tbl 14

NOTE:

1. Upon completion of the Burst sequence the counter wraps around to its initial state.

Linear Burst Sequence Table ($\overline{LBO} = V_{SS}$)

	Sequence 1		Sequence 2		Sequence 3		Sequence 4	
	A1	A0	A1	A0	A1	A0	A1	A0
First Address	0	0	0	1	1	0	1	1
Second Address	0	1	1	0	1	1	0	0
Third Address	1	0	1	1	0	0	0	1
Fourth Address ⁽¹⁾	1	1	0	0	0	1	1	0

6450 tbl 15

NOTE:

1. Upon completion of the Burst sequence the counter wraps around to its initial state.

AC Electrical Characteristics

(VDD = 3.3V ±5%, Commercial and Industrial Temperature Ranges)

Symbol	Parameter	6.5ns ⁽⁵⁾		7.5ns		8ns		8.5ns		Unit
		Min.	Max.	Min.	Max.	Min.	Max.	Min.	Max.	
Clock Parameter										
t _{CYC}	Clock Cycle Time	7.5	—	8.5	—	10	—	11.5	—	ns
t _{CH} ⁽¹⁾	Clock High Pulse Width	2.5	—	3	—	4	—	4.5	—	ns
t _{CL} ⁽¹⁾	Clock Low Pulse Width	2.5	—	3	—	4	—	4.5	—	ns
Output Parameters										
t _{CD}	Clock High to Valid Data	—	6.5	—	7.5	—	8	—	8.5	ns
t _{CDC}	Clock High to Data Change	2	—	2	—	2	—	2	—	ns
t _{CLZ} ⁽²⁾	Clock High to Output Active	0	—	0	—	0	—	0	—	ns
t _{CHZ} ⁽²⁾	Clock High to Data High-Z	2	3.5	2	3.5	2	3.5	2	3.5	ns
t _{OE}	Output Enable Access Time	—	3.5	—	3.5	—	3.5	—	3.5	ns
t _{OLZ} ⁽²⁾	Output Enable Low to Output Active	0	—	0	—	0	—	0	—	ns
t _{OHZ} ⁽²⁾	Output Enable High to Output High-Z	—	3.5	—	3.5	—	3.5	—	3.5	ns
Set Up Times										
t _{SA}	Address Setup Time	1.5	—	1.5	—	2	—	2	—	ns
t _{SS}	Address Status Setup Time	1.5	—	1.5	—	2	—	2	—	ns
t _{SD}	Data In Setup Time	1.5	—	1.5	—	2	—	2	—	ns
t _{SW}	Write Setup Time	1.5	—	1.5	—	2	—	2	—	ns
t _{SAV}	Address Advance Setup Time	1.5	—	1.5	—	2	—	2	—	ns
t _{SC}	Chip Enable/Select Setup Time	1.5	—	1.5	—	2	—	2	—	ns
Hold Times										
t _{HA}	Address Hold Time	0.5	—	0.5	—	0.5	—	0.5	—	ns
t _{HS}	Address Status Hold Time	0.5	—	0.5	—	0.5	—	0.5	—	ns
t _{HD}	Data In Hold Time	0.5	—	0.5	—	0.5	—	0.5	—	ns
t _{HW}	Write Hold Time	0.5	—	0.5	—	0.5	—	0.5	—	ns
t _{HAV}	Address Advance Hold Time	0.5	—	0.5	—	0.5	—	0.5	—	ns
t _{HC}	Chip Enable/Select Hold Time	0.5	—	0.5	—	0.5	—	0.5	—	ns
Sleep Mode and Configuration Parameters										
t _{ZZPW}	ZZ Pulse Width	100	—	100	—	100	—	100	—	ns
t _{ZZR} ⁽³⁾	ZZ Recovery Time	100	—	100	—	100	—	100	—	ns
t _{CFG} ⁽⁴⁾	Configuration Set-up Time	30	—	34	—	40	—	50	—	ns

NOTES:

1. Measured as HIGH above V_{IH} and LOW below V_{IL}.
2. Transition is measured ±200mV from steady-state.
3. Device must be deselected when powered-up from sleep mode.
4. t_{CFG} is the minimum time required to configure the device based on the $\overline{\text{LBO}}$ input. $\overline{\text{LBO}}$ is a static input and must not change during normal operation.
5. 6.5ns speed only available in TQFP package and in commercial temp range.

6450 tbl 16

Timing Waveform of Combined Flow-Through Read and Write Cycles (1,2,3)



6450 dtw 07

NOTES:

1. Device is selected through entire cycle; \overline{CE} and $\overline{CS_1}$ are LOW, $\overline{CS_0}$ is HIGH.
2. ZZ input is LOW and LBO is Don't Care for this cycle.
3. O1 (Ax) represents the first output from the external address Ax. I1 (Ay) represents the first input from the external address Ay. O1 (Az) represents the first output from the external address Az. O2 (Az) represents the next output data in the burst sequence of the base address Az, etc. where A0 and A1 are advancing for the four word burst in the sequence defined by the state of the LBO input.

Timing Waveform of Write Cycle No. 1 - **GW** Controlled (1,2,3)



6450 drw 08

NOTES:

1. Z \bar{Z} input is LOW, \overline{BWE} is HIGH and \overline{LBO} is Don't Care for this cycle.
2. $O_4(A_w)$ represents the final output data in the burst sequence of the base address A_w . $I_1(A_x)$ represents the first input from the external address A_y ; $I_2(A_y)$ represents the next input data in the burst sequence of the base address A_y , etc. where A_0 and A_1 are advancing for the four word burst in the sequence defined by the state of the \overline{LBO} input. In the case of input $I_2(A_y)$ this data is valid for two cycles because \overline{ADV} is high and has suspended the burst.
3. $\overline{CS0}$ timing transitions are identical but inverted to the \overline{CE} and $\overline{CS1}$ signals. For example, when \overline{CE} and $\overline{CS1}$ are LOW on this waveform, $\overline{CS0}$ is HIGH.

Timing Waveform of Write Cycle No. 2 - Byte Controlled (1,2,3)

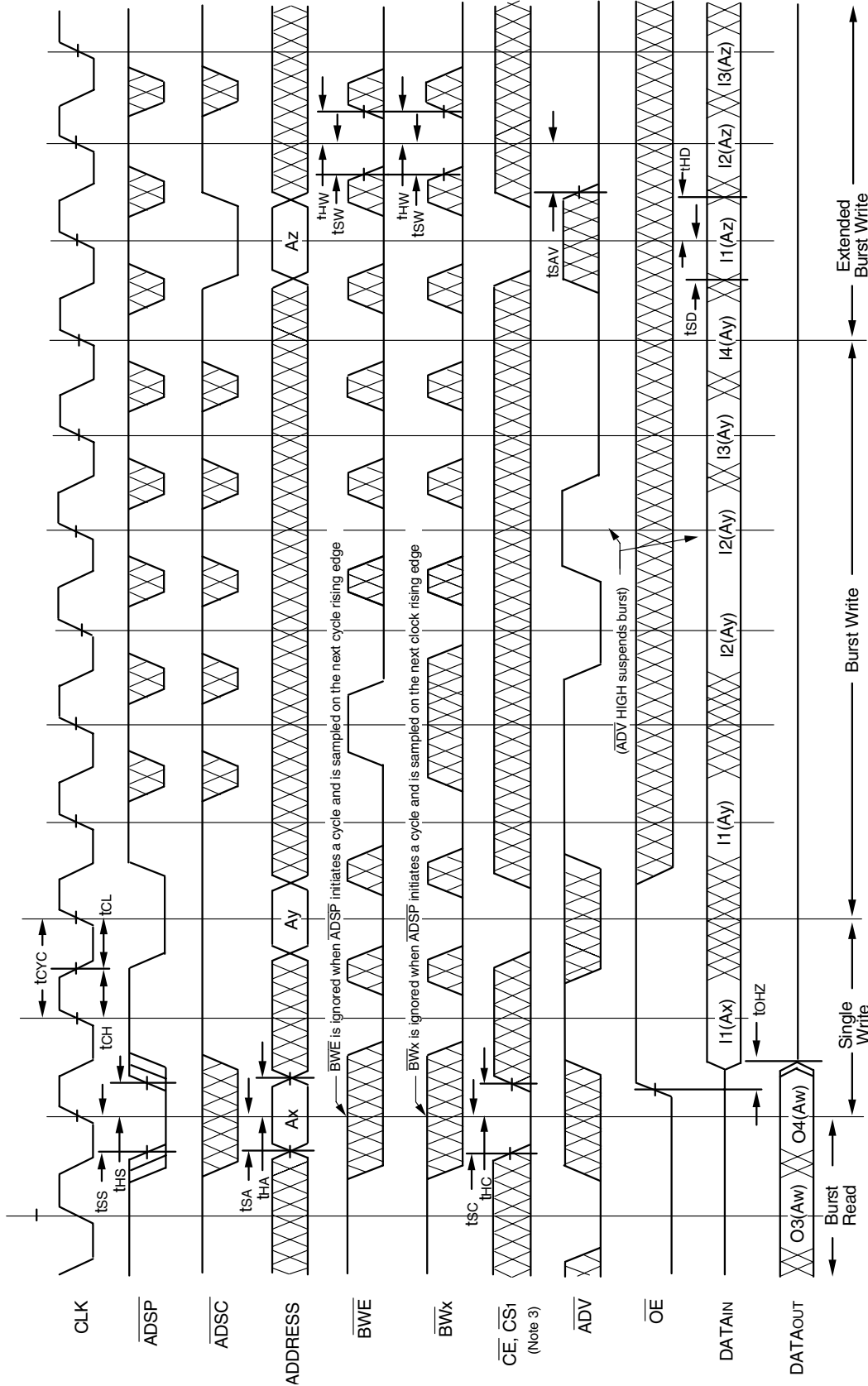

6450 drw.09

NOTES:

1. ZZ input is LOW, \overline{GW} is HIGH and \overline{LBO} is Don't Care for this cycle.
2. O4 (Aw) represents the final output data in the burst sequence of the base address Aw. I1 (Ax) represents the first input from the external address Ay; I2 (Ay) represents the next input data in the burst sequence of the base address Ay, etc. where A0 and A1 are advancing for the four word burst in the sequence defined by the state of the LBO input. In the case of input I2 (Ay) this data is valid for two cycles because ADV is high and has suspended the burst.
3. CS0 timing transitions are identical but inverted to the \overline{CE} and $\overline{CS1}$ signals. For example, when \overline{CE} and $\overline{CS1}$ are LOW on this waveform, CS0 is HIGH.

Timing Waveform of Sleep (ZZ) and Power-Down Modes (1,2,3)



6450 drw 13

NOTES:

1. Device must power up in deselected Mode.
2. LBO is Don't Care for this cycle.
3. It is not necessary to retain the state of the input registers throughout the Power-down cycle.
4. CS0 timing transitions are identical but inverted to the CE and CS1 signals. For example, when CE and CS1 are LOW on this waveform, CS0 is HIGH.

Non-Burst Read Cycle Timing Waveform

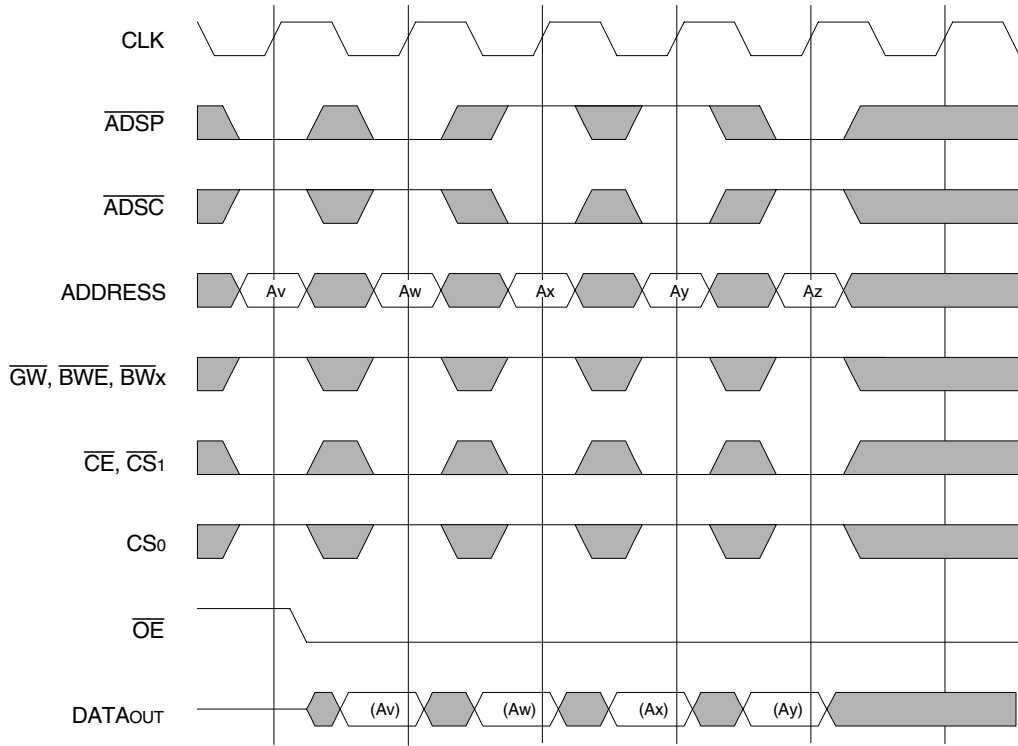

NOTES:

1. ZZ input is LOW, \overline{ADV} is HIGH and \overline{LBO} is Don't Care for this cycle.
2. (Ax) represents the data for address Ax, etc.
3. For read cycles, \overline{ADSP} and \overline{ADSC} function identically and are therefore interchangeable.

6450 drw 10

Non-Burst Write Cycle Timing Waveform

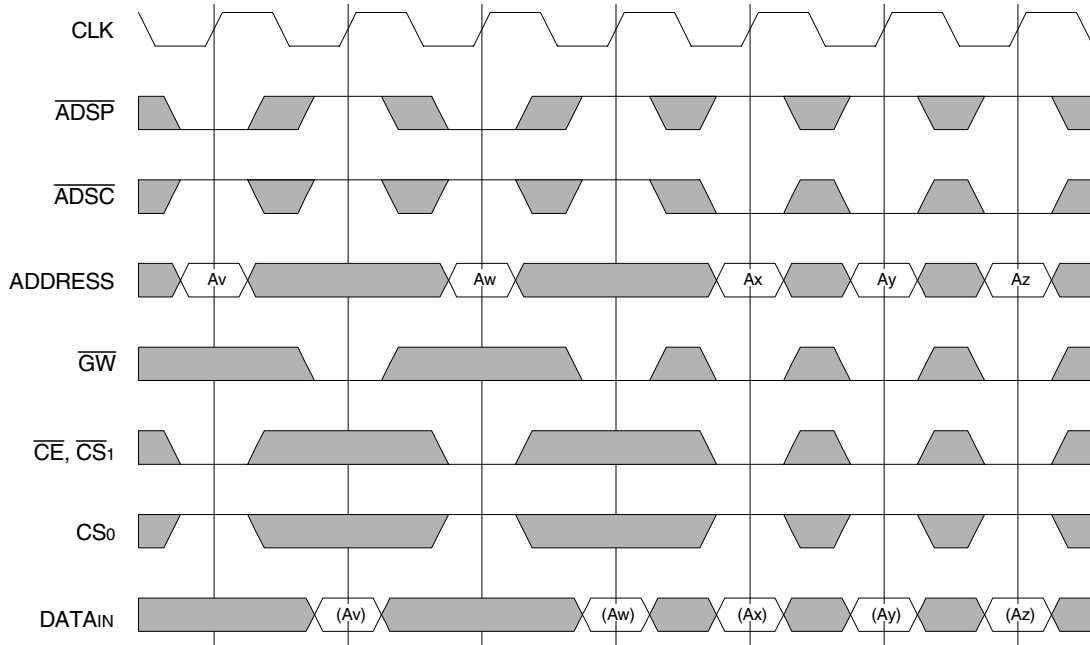

NOTES:

1. ZZ input is LOW, \overline{ADV} and \overline{OE} are HIGH, and \overline{LBO} is Don't Care for this cycle.
2. (Ax) represents the data for address Ax, etc.
3. Although only \overline{GW} writes are shown, the functionality of \overline{BWE} and \overline{BWx} together is the same as \overline{GW} .
4. For write cycles, \overline{ADSP} and \overline{ADSC} have different limitations.

6450 drw 11

JTAG Interface Specification (SA Version only)

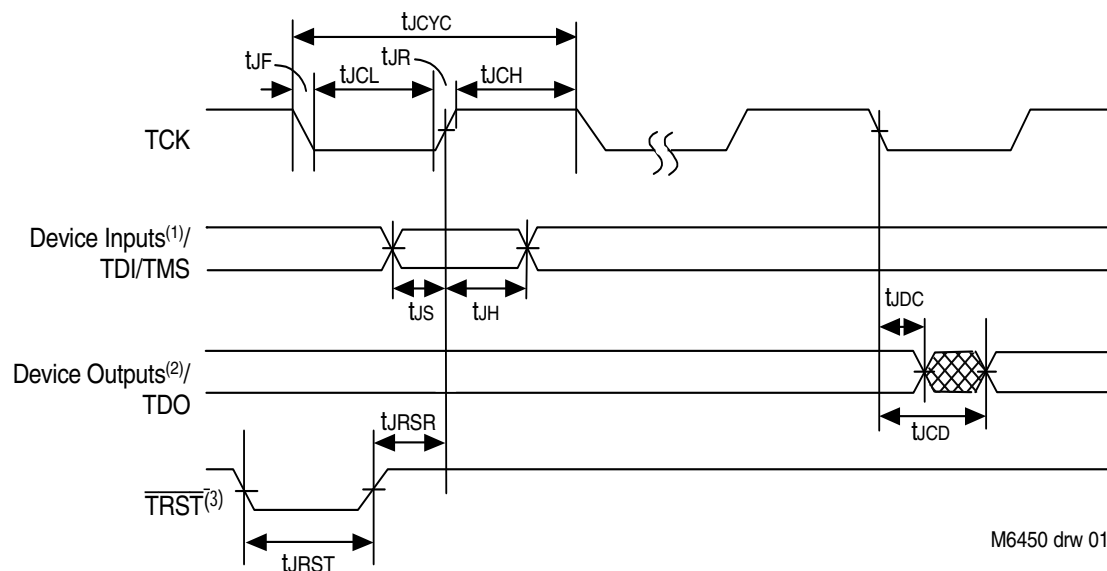

NOTES:

1. Device inputs = All device inputs except TDI, TMS and \overline{TRST} .
2. Device outputs = All device outputs except TDO.
3. During power up, \overline{TRST} could be driven low or not be used since the JTAG circuit resets automatically. \overline{TRST} is an optional JTAG reset.

JTAG AC Electrical Characteristics^(1,2,3,4)

Symbol	Parameter			
		Min.	Max.	Units
t_{JCYC}	JTAG Clock Input Period	100	—	ns
t_{JCH}	JTAG Clock HIGH	40	—	ns
t_{JCL}	JTAG Clock Low	40	—	ns
t_{JR}	JTAG Clock Rise Time	—	5 ⁽¹⁾	ns
t_{JF}	JTAG Clock Fall Time	—	5 ⁽¹⁾	ns
t_{JRST}	JTAG Reset	50	—	ns
t_{JRSR}	JTAG Reset Recovery	50	—	ns
t_{JCD}	JTAG Data Output	—	20	ns
t_{JDC}	JTAG Data Output Hold	0	—	ns
t_{JS}	JTAG Setup	25	—	ns
t_{JH}	JTAG Hold	25	—	ns

l6450 tbl 01

NOTES:

1. Guaranteed by design.
2. AC Test Load (Fig. 1) on external output signals.
3. Refer to AC Test Conditions stated earlier in this document.
4. JTAG operations occur at one speed (10MHz). The base device may run at any speed specified in this datasheet.

Scan Register Sizes

Register Name	Bit Size
Instruction (IR)	4
Bypass (BYR)	1
JTAG Identification (JIDR)	32
Boundary Scan (BSR)	Note (1)

l6450 tbl 03

NOTE:

1. The Boundary Scan Descriptive Language (BSDL) file for this device is available by contacting your local IDT sales representative.

JTAG Identification Register Definitions (SA Version only)

Instruction Field	Value	Description
Revision Number (31:28)	0x2	Reserved for version number.
IDT Device ID (27:12)	0x22C, 0x22E	Defines IDT part number 71V3577YSA and 71V3579YSA, respectively.
IDT JEDEC ID (11:1)	0x33	Allows unique identification of device vendor as IDT.
ID Register Indicator Bit (Bit 0)	1	Indicates the presence of an ID register.

I6450 tbl 02

Available JTAG Instructions

Instruction	Description	OPCODE
EXTEST	Forces contents of the boundary scan cells onto the device outputs ⁽¹⁾ . Places the boundary scan register (BSR) between TDI and TDO.	0000
SAMPLE/PRELOAD	Places the boundary scan register (BSR) between TDI and TDO. SAMPLE allows data from device inputs ⁽²⁾ and outputs ⁽¹⁾ to be captured in the boundary scan cells and shifted serially through TDO. PRELOAD allows data to be input serially into the boundary scan cells via the TDI.	0001
DEVICE_ID	Loads the JTAG ID register (JIDR) with the vendor ID code and places the register between TDI and TDO.	0010
HIGHZ	Places the bypass register (BYR) between TDI and TDO. Forces all device output drivers to a High-Z state.	0011
RESERVED	Several combinations are reserved. Do not use codes other than those identified for EXTEST, SAMPLE/PRELOAD, DEVICE_ID, HIGHZ, CLAMP, VALIDATE and BYPASS instructions.	0100
RESERVED		0101
RESERVED		0110
RESERVED		0111
CLAMP	Uses BYR. Forces contents of the boundary scan cells onto the device outputs. Places the bypass register (BYR) between TDI and TDO.	1000
RESERVED	Same as above.	1001
RESERVED		1010
RESERVED		1011
RESERVED		1100
VALIDATE	Automatically loaded into the instruction register whenever the TAP controller passes through the CAPTURE-IR state. The lower two bits '01' are mandated by the IEEE std. 1149.1 specification.	1101
RESERVED	Same as above.	1110
BYPASS	The BYPASS instruction is used to truncate the boundary scan register as a single bit in length.	1111

I6450 tbl 04

NOTES:

1. Device outputs = All device outputs except TDO.
2. Device inputs = All device inputs except TDI, TMS, and TRST.

Ordering Information



6450 drw 12

*6.5ns speed only available in TQFP package and commercial temp range.
 **JTAG (SA version) is not available with 100 pin TQFP package.

Package Information

100 Pin Thin Quad Plastic Flatpack (TQFP)

119 Ball Grid Array (BGA)

165 Fine Pitch Ball Grid Array (fBGA)

Information available on the IDT website

Datasheet Document History

01/30/04		Released Y generation die step datasheet
04/17/06	Pg. 21	Added green (Restricted hazardous substance device) to the datasheet.
04/02/12	Pg. 9	Added Industrial temp range values to the 7.5ns speed in the DC chars table
	Pg. 21	Removed die step indicator from the ordering information. Added tape and reel and green to the ordering information. Removed IDT from the ordering information.
	Pg. 1, 12 & 21	Added 6.5ns speed only available in TQFP package and in commercial temp range.

IMPORTANT NOTICE AND DISCLAIMER

RENESAS ELECTRONICS CORPORATION AND ITS SUBSIDIARIES (“RENESAS”) PROVIDES TECHNICAL SPECIFICATIONS AND RELIABILITY DATA (INCLUDING DATASHEETS), DESIGN RESOURCES (INCLUDING REFERENCE DESIGNS), APPLICATION OR OTHER DESIGN ADVICE, WEB TOOLS, SAFETY INFORMATION, AND OTHER RESOURCES “AS IS” AND WITH ALL FAULTS, AND DISCLAIMS ALL WARRANTIES, EXPRESS OR IMPLIED, INCLUDING, WITHOUT LIMITATION, ANY IMPLIED WARRANTIES OF MERCHANTABILITY, FITNESS FOR A PARTICULAR PURPOSE, OR NON-INFRINGEMENT OF THIRD PARTY INTELLECTUAL PROPERTY RIGHTS.

These resources are intended for developers skilled in the art designing with Renesas products. You are solely responsible for (1) selecting the appropriate products for your application, (2) designing, validating, and testing your application, and (3) ensuring your application meets applicable standards, and any other safety, security, or other requirements. These resources are subject to change without notice. Renesas grants you permission to use these resources only for development of an application that uses Renesas products. Other reproduction or use of these resources is strictly prohibited. No license is granted to any other Renesas intellectual property or to any third party intellectual property. Renesas disclaims responsibility for, and you will fully indemnify Renesas and its representatives against, any claims, damages, costs, losses, or liabilities arising out of your use of these resources. Renesas' products are provided only subject to Renesas' Terms and Conditions of Sale or other applicable terms agreed to in writing. No use of any Renesas resources expands or otherwise alters any applicable warranties or warranty disclaimers for these products.

(Rev.1.0 Mar 2020)

Corporate Headquarters

TOYOSU FORESIA, 3-2-24 Toyosu,
Koto-ku, Tokyo 135-0061, Japan
www.renesas.com

Contact Information

For further information on a product, technology, the most up-to-date version of a document, or your nearest sales office, please visit:
www.renesas.com/contact/

Trademarks

Renesas and the Renesas logo are trademarks of Renesas Electronics Corporation. All trademarks and registered trademarks are the property of their respective owners.