

CRYSTAL OSCILLATOR (Programmable)  
SPREAD SPECTRUM  
OUTPUT: CMOS



Product Number  
**SG-9101CA: X1G005301xxxx00**  
**SG-9101CB: X1G005311xxxx00**  
**SG-9101CE: X1G005321xxxx00**  
**SG-9101CG: X1G005291xxxx00**

## SG-9101 series

- Frequency range : 0.67 MHz to 170 MHz (1 ppm Step)
- Supply voltage : 1.62 V to 3.63 V
- Function : Output enable (OE) or Standby ( $\overline{ST}$ )
- Configurable spread spectrum settings:  
2 kinds of spread type, 6 kinds of spread width  
4 kinds of modulation frequency, 3 kinds of spread profile
- PLL technology to enable short lead time
- Available field oscillator programmer "SG-Writer II"



### Specifications (characteristics)

| Item  | Symbol                                      | Specifications   |                        |                        |  | Conditions/Remarks   |  |   |  |      |  |  |  |                |          |    |    |    |    |   |                 |      |      |      |      |                 |     |     |     |     |                                       |                 |      |      |      |      |                 |     |     |     |     |      |                 |      |      |      |      |                 |     |     |     |     |
|---|---|--|------------------------|------------------------|--|--|--|---|--|------|--|--|--|----------------|----------|----|----|----|----|---|-----------------|------|------|------|------|-----------------|-----|-----|-----|-----|---------------------------------------|-----------------|------|------|------|------|-----------------|-----|-----|-----|-----|------|-----------------|------|------|------|------|-----------------|-----|-----|-----|-----|
| Supply voltage                              | $V_{CC}$                                    | 1.80 V Typ.  |                        | 2.50 V Typ.            | 3.30 V Typ.                                  | -  |  |   |  |      |  |  |  |                |          |    |    |    |    |   |                 |      |      |      |      |                 |     |     |     |     |                                       |                 |      |      |      |      |                 |     |     |     |     |      |                 |      |      |      |      |                 |     |     |     |     |
|   |   | 1.62 V to 1.98 V                                       | 1.98 V to 2.20 V       | 2.20 V to 2.80 V       | 2.70 V to 3.63 V                             |  |  |   |  |      |  |  |  |                |          |    |    |    |    |   |                 |      |      |      |      |                 |     |     |     |     |                                       |                 |      |      |      |      |                 |     |     |     |     |      |                 |      |      |      |      |                 |     |     |     |     |
| Output frequency range                      | $f_o$                                       | 0.67 MHz to 170 MHz                                    |                        |                        |  |  |  |   |  |      |  |  |  |                |          |    |    |    |    |   |                 |      |      |      |      |                 |     |     |     |     |                                       |                 |      |      |      |      |                 |     |     |     |     |      |                 |      |      |      |      |                 |     |     |     |     |
| Storage temperature                         | $T_{stg}$                                   | -40 °C to +125 °C                                      |                        |                        |  | Storage as single product.   |  |   |  |      |  |  |  |                |          |    |    |    |    |   |                 |      |      |      |      |                 |     |     |     |     |                                       |                 |      |      |      |      |                 |     |     |     |     |      |                 |      |      |      |      |                 |     |     |     |     |
| Operating temperature                       | $T_{use}$                                   | -40 °C to +85 °C                                       |                        |                        |  |  |  |   |  |      |  |  |  |                |          |    |    |    |    |   |                 |      |      |      |      |                 |     |     |     |     |                                       |                 |      |      |      |      |                 |     |     |     |     |      |                 |      |      |      |      |                 |     |     |     |     |
|   |   | -40 °C to +105 °C                                      |                        |                        |  |  |  |   |  |      |  |  |  |                |          |    |    |    |    |   |                 |      |      |      |      |                 |     |     |     |     |                                       |                 |      |      |      |      |                 |     |     |     |     |      |                 |      |      |      |      |                 |     |     |     |     |
| Frequency tolerance <sup>*1</sup>           | $f_{tol}$                                   | $\pm 50 \times 10^{-6}$                                |                        |                        |  | Average frequency of 1s gate time.   |  |   |  |      |  |  |  |                |          |    |    |    |    |   |                 |      |      |      |      |                 |     |     |     |     |                                       |                 |      |      |      |      |                 |     |     |     |     |      |                 |      |      |      |      |                 |     |     |     |     |
| Current consumption                         | $I_{CC}$                                    | 3.4 mA Max.  | 3.5 mA Max.            | 3.6 mA Max.            | 3.7 mA Max.                                  | $T_{use} = +105 \text{ °C}$  | No load, $f_o = 20 \text{ MHz}$                      |   |  |      |  |  |  |                |          |    |    |    |    |   |                 |      |      |      |      |                 |     |     |     |     |                                       |                 |      |      |      |      |                 |     |     |     |     |      |                 |      |      |      |      |                 |     |     |     |     |
|   |   | 2.9 mA Typ.  |                        | 3.0 mA Typ.            | 3.2 mA Typ.                                  | $T_{use} = +25 \text{ °C}$   |  |   |  |      |  |  |  |                |          |    |    |    |    |   |                 |      |      |      |      |                 |     |     |     |     |                                       |                 |      |      |      |      |                 |     |     |     |     |      |                 |      |      |      |      |                 |     |     |     |     |
|   |   | 5.7 mA Max.  | 6.0 mA Max.            | 6.9 mA Max.            | 8.3 mA Max.                                  | $T_{use} = +105 \text{ °C}$  | No load, $f_o = 170 \text{ MHz}$                     |   |  |      |  |  |  |                |          |    |    |    |    |   |                 |      |      |      |      |                 |     |     |     |     |                                       |                 |      |      |      |      |                 |     |     |     |     |      |                 |      |      |      |      |                 |     |     |     |     |
|   |   | 4.9 mA Typ.  |                        | 5.9 mA Typ.            | 7.0 mA Typ.                                  | $T_{use} = +25 \text{ °C}$   |  |   |  |      |  |  |  |                |          |    |    |    |    |   |                 |      |      |      |      |                 |     |     |     |     |                                       |                 |      |      |      |      |                 |     |     |     |     |      |                 |      |      |      |      |                 |     |     |     |     |
| Output disable current                      | $I_{dis}$                                   | 3.4 mA Max.  | 3.4 mA Max.            | 3.5 mA Max.            | 3.7 mA Max.                                  | OE = GND, $f_o = 170 \text{ MHz}$  |  |   |  |      |  |  |  |                |          |    |    |    |    |   |                 |      |      |      |      |                 |     |     |     |     |                                       |                 |      |      |      |      |                 |     |     |     |     |      |                 |      |      |      |      |                 |     |     |     |     |
| Standby current                             | $I_{std}$                                   | 0.9 $\mu\text{A}$ Max.                                 | 1.0 $\mu\text{A}$ Max. | 1.5 $\mu\text{A}$ Max. | 2.5 $\mu\text{A}$ Max.                       | $T_{use} = +105 \text{ °C}$  | $\overline{ST} = \text{GND}$                         |   |  |      |  |  |  |                |          |    |    |    |    |   |                 |      |      |      |      |                 |     |     |     |     |                                       |                 |      |      |      |      |                 |     |     |     |     |      |                 |      |      |      |      |                 |     |     |     |     |
|   |   | 0.3 $\mu\text{A}$ Typ.                                 | 0.4 $\mu\text{A}$ Typ. | 0.5 $\mu\text{A}$ Typ. | 1.1 $\mu\text{A}$ Typ.                       | $T_{use} = +25 \text{ °C}$   |  |   |  |      |  |  |  |                |          |    |    |    |    |   |                 |      |      |      |      |                 |     |     |     |     |                                       |                 |      |      |      |      |                 |     |     |     |     |      |                 |      |      |      |      |                 |     |     |     |     |
| Symmetry                                    | SYM   | 45 % to 55 %   |                        |                        |  | 50 % $V_{CC}$ Level  |  |   |  |      |  |  |  |                |          |    |    |    |    |   |                 |      |      |      |      |                 |     |     |     |     |                                       |                 |      |      |      |      |                 |     |     |     |     |      |                 |      |      |      |      |                 |     |     |     |     |
| Output voltage<br>(DC characteristics)      | $V_{OH}$                                    | 90 % $V_{CC}$ Min.                                     |                        |                        |  | <table border="1"> <thead> <tr> <th colspan="2">I<sub>OH</sub>/I<sub>OL</sub> Conditions</th> <th colspan="4">[mA]</th> </tr> <tr> <th>Rise/Fall time</th> <th><math>V_{CC}</math></th> <th>*A</th> <th>*B</th> <th>*C</th> <th>*D</th> </tr> </thead> <tbody> <tr> <td rowspan="2">Default (<math>f_o &gt; 40 \text{ MHz}</math>),<br/>Fast</td> <td>I<sub>OH</sub></td> <td>-2.5</td> <td>-3.5</td> <td>-4.0</td> <td>-5.0</td> </tr> <tr> <td>I<sub>OL</sub></td> <td>2.5</td> <td>3.5</td> <td>4.0</td> <td>5.0</td> </tr> <tr> <td rowspan="2">Default (<math>f_o \leq 40 \text{ MHz}</math>)</td> <td>I<sub>OH</sub></td> <td>-1.5</td> <td>-2.0</td> <td>-2.5</td> <td>-3.0</td> </tr> <tr> <td>I<sub>OL</sub></td> <td>1.5</td> <td>2.0</td> <td>2.5</td> <td>3.0</td> </tr> <tr> <td rowspan="2">Slow</td> <td>I<sub>OH</sub></td> <td>-1.0</td> <td>-1.5</td> <td>-2.0</td> <td>-2.5</td> </tr> <tr> <td>I<sub>OL</sub></td> <td>1.0</td> <td>1.5</td> <td>2.0</td> <td>2.5</td> </tr> </tbody> </table> |  | I <sub>OH</sub> /I <sub>OL</sub> Conditions |  | [mA] |  |  |  | Rise/Fall time | $V_{CC}$ | *A | *B | *C | *D | Default ( $f_o > 40 \text{ MHz}$ ),<br>Fast | I <sub>OH</sub> | -2.5 | -3.5 | -4.0 | -5.0 | I <sub>OL</sub> | 2.5 | 3.5 | 4.0 | 5.0 | Default ( $f_o \leq 40 \text{ MHz}$ ) | I <sub>OH</sub> | -1.5 | -2.0 | -2.5 | -3.0 | I <sub>OL</sub> | 1.5 | 2.0 | 2.5 | 3.0 | Slow | I <sub>OH</sub> | -1.0 | -1.5 | -2.0 | -2.5 | I <sub>OL</sub> | 1.0 | 1.5 | 2.0 | 2.5 |
|   | I <sub>OH</sub> /I <sub>OL</sub> Conditions |  | [mA]                   |                        |  |  |  |   |  |      |  |  |  |                |          |    |    |    |    |   |                 |      |      |      |      |                 |     |     |     |     |                                       |                 |      |      |      |      |                 |     |     |     |     |      |                 |      |      |      |      |                 |     |     |     |     |
| Rise/Fall time                              | $V_{CC}$                                    | *A   | *B                     | *C                     | *D   |  |  |   |  |      |  |  |  |                |          |    |    |    |    |   |                 |      |      |      |      |                 |     |     |     |     |                                       |                 |      |      |      |      |                 |     |     |     |     |      |                 |      |      |      |      |                 |     |     |     |     |
| Default ( $f_o > 40 \text{ MHz}$ ),<br>Fast | I <sub>OH</sub>                             | -2.5   | -3.5                   | -4.0                   | -5.0   |  |  |   |  |      |  |  |  |                |          |    |    |    |    |   |                 |      |      |      |      |                 |     |     |     |     |                                       |                 |      |      |      |      |                 |     |     |     |     |      |                 |      |      |      |      |                 |     |     |     |     |
|   | I <sub>OL</sub>                             | 2.5  | 3.5                    | 4.0                    | 5.0  |  |  |   |  |      |  |  |  |                |          |    |    |    |    |   |                 |      |      |      |      |                 |     |     |     |     |                                       |                 |      |      |      |      |                 |     |     |     |     |      |                 |      |      |      |      |                 |     |     |     |     |
| Default ( $f_o \leq 40 \text{ MHz}$ )       | I <sub>OH</sub>                             | -1.5   | -2.0                   | -2.5                   | -3.0   |  |  |   |  |      |  |  |  |                |          |    |    |    |    |   |                 |      |      |      |      |                 |     |     |     |     |                                       |                 |      |      |      |      |                 |     |     |     |     |      |                 |      |      |      |      |                 |     |     |     |     |
|   | I <sub>OL</sub>                             | 1.5  | 2.0                    | 2.5                    | 3.0  |  |  |   |  |      |  |  |  |                |          |    |    |    |    |   |                 |      |      |      |      |                 |     |     |     |     |                                       |                 |      |      |      |      |                 |     |     |     |     |      |                 |      |      |      |      |                 |     |     |     |     |
| Slow  | I <sub>OH</sub>                             | -1.0   | -1.5                   | -2.0                   | -2.5   |  |  |   |  |      |  |  |  |                |          |    |    |    |    |   |                 |      |      |      |      |                 |     |     |     |     |                                       |                 |      |      |      |      |                 |     |     |     |     |      |                 |      |      |      |      |                 |     |     |     |     |
|   | I <sub>OL</sub>                             | 1.0  | 1.5                    | 2.0                    | 2.5  |  |  |   |  |      |  |  |  |                |          |    |    |    |    |   |                 |      |      |      |      |                 |     |     |     |     |                                       |                 |      |      |      |      |                 |     |     |     |     |      |                 |      |      |      |      |                 |     |     |     |     |
| $V_{OL}$                                    | 10 % $V_{CC}$ Max.                          |  |                        |                        |  |  |  |   |  |      |  |  |  |                |          |    |    |    |    |   |                 |      |      |      |      |                 |     |     |     |     |                                       |                 |      |      |      |      |                 |     |     |     |     |      |                 |      |      |      |      |                 |     |     |     |     |
| Output load condition                       | $L_{CMOS}$                                  | 15 pF Max.   |                        |                        |  | -  |  |   |  |      |  |  |  |                |          |    |    |    |    |   |                 |      |      |      |      |                 |     |     |     |     |                                       |                 |      |      |      |      |                 |     |     |     |     |      |                 |      |      |      |      |                 |     |     |     |     |
| Input voltage                               | $V_{IH}$                                    | 70 % $V_{CC}$ Min.                                     |                        |                        |  | OE or $\overline{ST}$  |  |   |  |      |  |  |  |                |          |    |    |    |    |   |                 |      |      |      |      |                 |     |     |     |     |                                       |                 |      |      |      |      |                 |     |     |     |     |      |                 |      |      |      |      |                 |     |     |     |     |
|   | $V_{IL}$                                    | 30 % $V_{CC}$ Max.                                     |                        |                        |  |  |  |   |  |      |  |  |  |                |          |    |    |    |    |   |                 |      |      |      |      |                 |     |     |     |     |                                       |                 |      |      |      |      |                 |     |     |     |     |      |                 |      |      |      |      |                 |     |     |     |     |
| Rise time<br>/Fall time                     | Default<br>Fast<br>Slow                     | $t_{r/tf}$   | 3.0 ns Max.            |                        | $f_o > 40 \text{ MHz}$                       |  | 20 % - 80 % $V_{CC}$ ,<br>$L_{CMOS} = 15 \text{ pF}$ |   |  |      |  |  |  |                |          |    |    |    |    |   |                 |      |      |      |      |                 |     |     |     |     |                                       |                 |      |      |      |      |                 |     |     |     |     |      |                 |      |      |      |      |                 |     |     |     |     |
|   |   |  | 6.0 ns Max.            |                        | $f_o \leq 40 \text{ MHz}$                    |  |  |   |  |      |  |  |  |                |          |    |    |    |    |   |                 |      |      |      |      |                 |     |     |     |     |                                       |                 |      |      |      |      |                 |     |     |     |     |      |                 |      |      |      |      |                 |     |     |     |     |
|   |   |  | 3.0 ns Max.            |                        | $f_o = 0.67 \text{ MHz to } 170 \text{ MHz}$ |  |  |   |  |      |  |  |  |                |          |    |    |    |    |   |                 |      |      |      |      |                 |     |     |     |     |                                       |                 |      |      |      |      |                 |     |     |     |     |      |                 |      |      |      |      |                 |     |     |     |     |
|   |   |  | 10.0 ns Max.           |                        | $f_o = 0.67 \text{ MHz to } 20 \text{ MHz}$  |  |  |   |  |      |  |  |  |                |          |    |    |    |    |   |                 |      |      |      |      |                 |     |     |     |     |                                       |                 |      |      |      |      |                 |     |     |     |     |      |                 |      |      |      |      |                 |     |     |     |     |
| Output disable time (OE)                    | $t_{stp\_oe}$                               | 1 $\mu\text{s}$ Max.                                   |                        |                        |  | Measured from the time OE or $\overline{ST}$ pin crosses 30 % $V_{CC}$   |  |   |  |      |  |  |  |                |          |    |    |    |    |   |                 |      |      |      |      |                 |     |     |     |     |                                       |                 |      |      |      |      |                 |     |     |     |     |      |                 |      |      |      |      |                 |     |     |     |     |
| Output disable time (ST)                    | $t_{stp\_st}$                               | 1 $\mu\text{s}$ Max.                                   |                        |                        |  | Measured from the time OE pin crosses 70 % $V_{CC}$  |  |   |  |      |  |  |  |                |          |    |    |    |    |   |                 |      |      |      |      |                 |     |     |     |     |                                       |                 |      |      |      |      |                 |     |     |     |     |      |                 |      |      |      |      |                 |     |     |     |     |
| Output enable time (OE)                     | $t_{sta\_oe}$                               | 1 $\mu\text{s}$ Max.                                   |                        |                        |  | Measured from the time OE pin crosses 70 % $V_{CC}$  |  |   |  |      |  |  |  |                |          |    |    |    |    |   |                 |      |      |      |      |                 |     |     |     |     |                                       |                 |      |      |      |      |                 |     |     |     |     |      |                 |      |      |      |      |                 |     |     |     |     |
| Output enable time (ST)                     | $t_{sta\_st}$                               | 3 ms Max.  |                        |                        |  | Measured from the time $\overline{ST}$ pin crosses 70 % $V_{CC}$   |  |   |  |      |  |  |  |                |          |    |    |    |    |   |                 |      |      |      |      |                 |     |     |     |     |                                       |                 |      |      |      |      |                 |     |     |     |     |      |                 |      |      |      |      |                 |     |     |     |     |
| Start-up time                               | $t_{str}$                                   | 3 ms Max.  |                        |                        |  | Measured from the time $V_{CC}$ reaches its rated minimum value, 1.62 V  |  |   |  |      |  |  |  |                |          |    |    |    |    |   |                 |      |      |      |      |                 |     |     |     |     |                                       |                 |      |      |      |      |                 |     |     |     |     |      |                 |      |      |      |      |                 |     |     |     |     |
| Frequency aging                             | $f_{age}$                                   | This is included in frequency tolerance specification. |                        |                        |  | +25 °C, first year   |  |   |  |      |  |  |  |                |          |    |    |    |    |   |                 |      |      |      |      |                 |     |     |     |     |                                       |                 |      |      |      |      |                 |     |     |     |     |      |                 |      |      |      |      |                 |     |     |     |     |

\*1 Frequency tolerance includes initial frequency tolerance, frequency / temperature characteristics, frequency / voltage coefficient, frequency / load coefficient and frequency aging (+25 °C, 1 year).

### Pin description

| Pin | Name            | I/O type | Function      |  |
|-----|-----------------|----------|---------------|--|
| 1   | OE              | Input    | Output enable | High <sup>*2</sup> : Specified frequency output from OUT pin<br>Low: Out pin is low (weak pull down), only output driver is disabled.  |
|     | $\overline{ST}$ | Input    | Standby       | High <sup>*2</sup> : Specified frequency output from OUT pin<br>Low: Out pin is low (weak pull down),<br>Device goes to standby mode. Supply current reduces to the least as $I_{std}$ . |
| 2   | GND             | Power    | Ground        |  |
| 3   | OUT             | Output   | Clock output  |  |
| 4   | $V_{CC}$        | Power    | Power supply  |  |

\*2 Please do not use the OE/ST terminal in the open state.



Product Name

SG-9101CG 170.000000MHz C 20 P H A A A  
① ② ③ ④ ⑤ ⑥ ⑦ ⑧ ⑨ ⑩

- ① Model ② Package type ③ Frequency
- ④ Spread type ⑤ Spread width
- ⑥ Function ⑦ Operating temperature
- ⑧ Modulation frequency ⑨ Spread profile
- ⑩ Rise/Fall time

| ② Package type |                 |
|----------------|-----------------|
| CG             | 2.5 mm × 2.0 mm |
| CE             | 3.2 mm × 2.5 mm |
| CB             | 5.0 mm × 3.2 mm |
| CA             | 7.0 mm × 5.0 mm |

| ④ Spread type |               |
|---------------|---------------|
| C             | Center spread |
| D             | Down spread   |

| ⑤ Spread width |               |             |
|----------------|---------------|-------------|
|                | Center spread | Down spread |
| 02             | ±0.25 %       |             |
| 05             | ±0.5 %        | -0.5 %      |
| 07             | ±0.75 %       |             |
| 10             | ±1.0 %        | -1.0 %      |
| 15             | ±1.5 %        | -1.5 %      |
| 20             | ±2.0 %        | -2.0 %      |
| 30             |               | -3.0 %      |
| 40             |               | -4.0 %      |

| ⑧ Modulation frequency |                    |
|------------------------|--------------------|
| A                      | 25.4 kHz (Default) |
| B                      | 12.7 kHz           |
| C                      | 8.5 kHz            |
| D                      | 6.3 kHz            |

| ⑨ Spread profile |                        |
|------------------|------------------------|
| A                | Hershey-kiss (Default) |
| B                | Sine-wave              |
| C                | Triangle               |

| ⑥ Function |               |
|------------|---------------|
| P          | Output enable |
| S          | Standby       |

| ⑩ Rise/Fall time |         |
|------------------|---------|
| A                | Default |
| B                | Fast    |
| C                | Slow    |

| ⑦ Operating temperature |                   |
|-------------------------|-------------------|
| G                       | -40 °C to +85 °C  |
| H                       | -40 °C to +105 °C |

External dimensions

(Unit: mm)

Footprint (Recommended)

(Unit: mm)

SG-9101CG

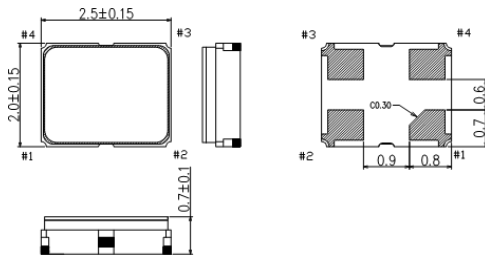

SG-9101CG

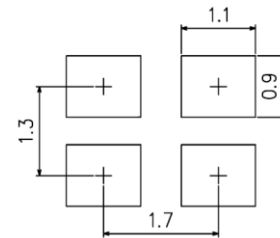

SG-9101CE

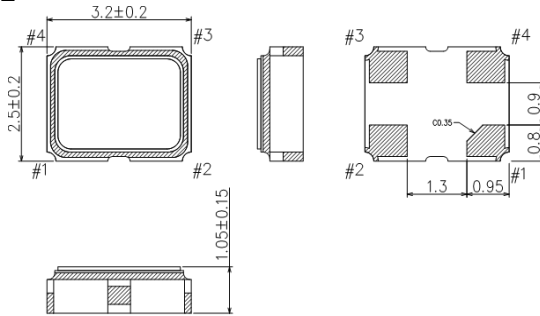

SG-9101CE

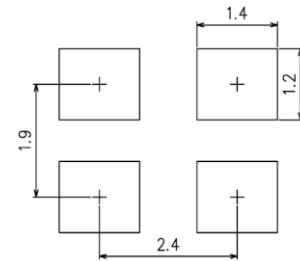

SG-9101CB

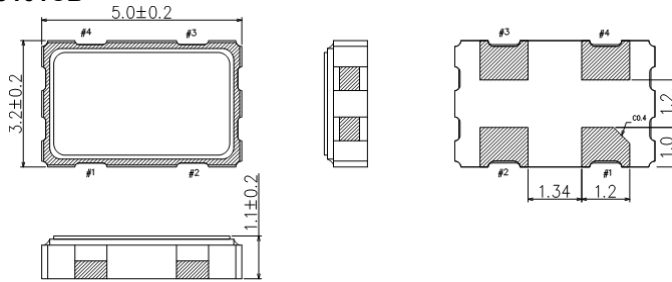

SG-9101CB

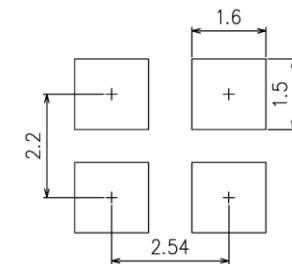

SG-9101CA

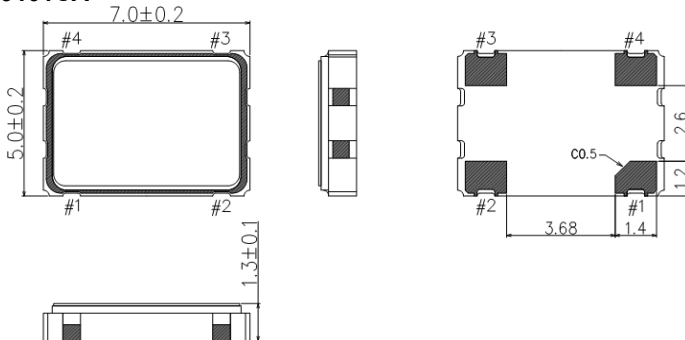

SG-9101CA

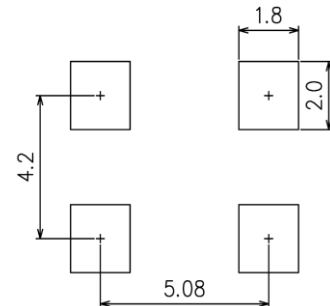

Notes:

In order to achieve optimum jitter performance, the 0.1 μF capacitor between V<sub>CC</sub> and GND should be placed. It is also recommended that the capacitors are placed on the device side of the PCB, as close to the device as possible and connected together with short wiring pattern.

## PROMOTION OF ENVIRONMENTAL MANAGEMENT SYSTEM CONFORMING TO INTERNATIONAL STANDARDS

At Seiko Epson, all environmental initiatives operate under the Plan-Do-Check-Action (PDCA) cycle designed to achieve continuous improvements. The environmental management system (EMS) operates under the ISO 14001 environmental management standard.

All of our major manufacturing and non-manufacturing sites, in Japan and overseas, completed the acquisition of ISO 14001 certification.

ISO 14000 is an international standard for environmental management that was established by the International Standards Organization in 1996 against the background of growing concern regarding global warming, destruction of the ozone layer, and global deforestation.

## WORKING FOR HIGH QUALITY

In order provide high quality and reliable products and services than meet customer needs, Seiko Epson made early efforts towards obtaining ISO9000 series certification and has acquired ISO9001 for all business establishments in Japan and abroad. We have also acquired IATF 16949 certification that is requested strongly by major automotive manufacturers as standard.

IATF 16949 is the international standard that added the sector-specific supplemental requirements for automotive industry based on ISO9001.

### ► Explanation of the mark that are using it for the catalog

|   |   |
|---|---|
|  | ► Pb free.  |
|  | ► Complies with EU RoHS directive.<br>*About the products without the Pb-free mark.<br>Contains Pb in products exempted by EU RoHS directive.<br>(Contains Pb in sealing glass, high melting temperature type solder or other.) |
|  | ► Designed for automotive applications such as Car Multimedia, Body Electronics, Remote Keyless Entry etc.  |
|  | ► Designed for automotive applications related to driving safety (Engine Control Unit, Air Bag, ESC etc ).  |

NOTICE : PLEASE READ CAREFULLY BELOW BEFORE THE USE OF THIS DOCUMENT ©Seiko Epson Corporation 2020

1. The content of this document is subject to change without notice. Before purchasing or using Epson products, please contact with sales representative of Seiko Epson Corporation ("Epson") for the latest information and be always sure to check the latest information published on Epson's official web sites and resources.
2. This document may not be copied, reproduced, or used for any other purposes, in whole or in part, without Epson's prior consent.
3. Information provided in this document including, but not limited to application circuits, programs and usage, is for reference purpose only. Epson makes no guarantees against any infringements or damages to any third parties' intellectual property rights or any other rights resulting from the information. This document does not grant you any licenses, any intellectual property rights or any other rights with respect to Epson products owned by Epson or any third parties.
4. Using Epson products, you shall be responsible for safe design in your products; that is, your hardware, software, and/or systems shall be designed enough to prevent any critical harm or damages to life, health or property, even if any malfunction or failure might be caused by Epson products. In designing your products with Epson products, please be sure to check and comply with the latest information regarding Epson products (including, but not limited to this document, specifications, data sheets, manuals, and Epson's web site). Using technical contents such as product data, graphic and chart, and technical information, including programs, algorithms and application circuit examples under this document, you shall evaluate your products thoroughly both in stand-alone basis and within your overall systems. You shall be solely responsible for deciding whether to adopt/use Epson products with your products.
5. Epson has prepared this document carefully to be accurate and dependable, but Epson does not guarantee that the information is always accurate and complete. Epson assumes no responsibility for any damages you incurred due to any misinformation in this document.
6. No dismantling, analysis, reverse engineering, modification, alteration, adaptation, reproduction, etc., of Epson products is allowed.
7. Epson products have been designed, developed and manufactured to be used in general electronic applications and specifically designated applications ("Anticipated Purpose"). Epson products are NOT intended for any use beyond the Anticipated Purpose that requires particular quality or extremely high reliability in order to refrain from causing any malfunction or failure leading to critical harm to life and health, serious property damage, or severe impact on society, including, but not limited to listed below ("Specific Purpose"). Therefore, you are strongly advised to use Epson products only for the Anticipated Purpose. Should you desire to purchase and use Epson products for Specific Purpose, Epson makes no warranty and disclaims with respect to Epson products, whether express or implied, including without limitation any implied warranty of merchantability or fitness for any Specific Purpose. Please be sure to contact our sales representative in advance, if you desire Epson products for Specific Purpose:
  - Space equipment (artificial satellites, rockets, etc.)/ Transportation vehicles and their control equipment (automobiles, aircraft, trains, ships, etc.) / Medical equipment/ Relay equipment to be placed on sea floor/ Power station control equipment / Disaster or crime prevention equipment/Traffic control equipment/ Financial equipment
  - Other applications requiring similar levels of reliability as the above
8. Epson products listed in this document and our associated technologies shall not be used in any equipment or systems that laws and regulations in Japan or any other countries prohibit to manufacture, use or sell. Furthermore, Epson products and our associated technologies shall not be used for the purposes of military weapons development (e.g. mass destruction weapons), military use, or any other military applications. If exporting Epson products or our associated technologies, please be sure to comply with the Foreign Exchange and Foreign Trade Control Act in Japan, Export Administration Regulations in the U.S.A (EAR) and other export-related laws and regulations in Japan and any other countries and to follow their required procedures.
9. Epson assumes no responsibility for any damages (whether direct or indirect) caused by or in relation with your non-compliance with the terms and conditions in this document or for any damages (whether direct or indirect) incurred by any third party that you give, transfer or assign Epson products.
10. For more details or other concerns about this document, please contact our sales representative.
11. Company names and product names listed in this document are trademarks or registered trademarks of their respective companies.