

## RD COAXIAL SWITCHES

Max. 26.5 GHz, Coaxial switches coming in SPDT, Transfer and SP6T types

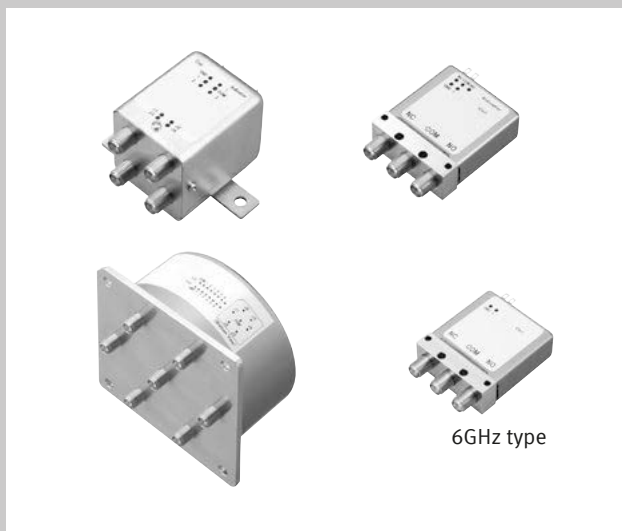

### FEATURES

- Excellent high frequency characteristics (50 Ω, up to 26.5 GHz)
- SPDT, Transfer and SP6T types are available.
- Coil driver (+ common type) is also available.
- High sensitivity; Expected electrical life: min.  $5 \times 10^6$

### TYPICAL APPLICATIONS

- Broadcasting and video equipment
- Communication equipment
- Measuring equipment
- Various inspection jigs

Note: If you consider using applications with low level loads or with high frequency switching, please consult our sales office.

### HIGH FREQUENCY CHARACTERISTICS

#### ■ 50 Ω (Initial)

#### ● SPDT and Transfer

Frequency	Up to 1 GHz	1 to 4 GHz	4 to 8 GHz*1	8 to 12.4 GHz	12.4 to 18 GHz	18 to 26.5 GHz*2
V.S.W.R. (max.)	1.1	1.15	1.25	1.35	1.5	1.7
Insertion loss (dB, max.)	0.2		0.3	0.4	0.5	0.8
Isolation (dB, min.)	85	80	70	65	60	55

\*1. The 6 GHz type only has the above characteristics up to 6 GHz.

\*2. 18 to 26.5 GHz characteristics can be applied 26.5GHz type only.

#### ● SP6T

Frequency	Up to 1 GHz	1 to 4 GHz	4 to 8 GHz	8 to 12.4 GHz	12.4 to 18 GHz
V.S.W.R. (max.)	1.1	1.15	1.25	1.35	1.5
Insertion loss (dB, max.)	0.2		0.3	0.4	1
Isolation (dB, min.)	85	80	70	65	60

## ORDERING INFORMATION (PART NO.)

### ARD



Note : 1. Sealed types also available, please consult our sales office. (SPDT only)  
 2. Packing style symbol "Q" is not marked on the relay.  
 3. 4.5 V DC is failsafe latching only, 5 V DC is TTL drive latching only.

## TYPES

### SPDT

● Solder terminal: Carton packing

Operating function	Rated coil voltage	Part No.					Standard packing		
		6 GHz		18 GHz		26.5 GHz		Inner carton	Outer carton
		No HF datasheet attached	No HF datasheet attached	HF datasheet attached	No HF datasheet attached	HF datasheet attached			
Fail-safe (with indicator)	4.5 V DC	ARD7004H	ARD1004H	ARD1004HQ	ARD5004H	ARD5004HQ	1 pc.	20 pcs.	
	12 V DC	ARD70012	ARD10012	ARD10012Q	ARD50012	ARD50012Q			
	24 V DC	ARD70024	ARD10024	ARD10024Q	ARD50024	ARD50024Q			
Latching (with indicator)	4.5 V DC	ARD7204H	ARD1204H	ARD1204HQ	ARD5204H	ARD5204HQ			
	12 V DC	ARD72012	ARD12012	ARD12012Q	ARD52012	ARD52012Q			
	24 V DC	ARD72024	ARD12024	ARD12024Q	ARD52024	ARD52024Q			
Latching with TTL driver (with self cut-off function) (with indicator)	5 V DC	ARD75105	ARD15105	ARD15105Q	ARD55105	ARD55105Q			
	12 V DC	ARD75112	ARD15112	ARD15112Q	ARD55112	ARD55112Q			
	24 V DC	ARD75124	ARD15124	ARD15124Q	ARD55124	ARD55124Q			
Fail-safe (without indicator)	4.5 V DC	ARD7024H	-	-	-	-			
	12 V DC	ARD70212	-	-	-	-			
	24 V DC	ARD70224	-	-	-	-			
Latching (without indicator)	4.5 V DC	ARD7224H	-	-	-	-			
	12 V DC	ARD72212	-	-	-	-			
	24 V DC	ARD72224	-	-	-	-			
Latching with TTL driver (with self cut-off function) (without indicator)	5 V DC	ARD75305	-	-	-	-			
	12 V DC	ARD75312	-	-	-	-			
	24 V DC	ARD75324	-	-	-	-			

● Connector cable: Carton packing

Operating function	Rated coil voltage	Part No.				Standard packing	
		18 GHz		26.5 GHz		Inner carton	Outer carton
		No HF datasheet attached	HF datasheet attached	No HF datasheet attached	HF datasheet attached		
Fail-safe	4.5 V DC	ARD1004HC	ARD1004HCQ	ARD5004HC	ARD5004HCQ	1 pc.	10 pcs.
	12 V DC	ARD10012C	ARD10012CQ	ARD50012C	ARD50012CQ		
	24 V DC	ARD10024C	ARD10024CQ	ARD50024C	ARD50024CQ		
Latching	4.5 V DC	ARD1204HC	ARD1204HCQ	ARD5204HC	ARD5204HCQ		
	12 V DC	ARD12012C	ARD12012CQ	ARD52012C	ARD52012CQ		
	24 V DC	ARD12024C	ARD12024CQ	ARD52024C	ARD52024CQ		
Latching with TTL driver (with self cut-off function)	5 V DC	ARD15105C	ARD15105CQ	ARD55105C	ARD55105CQ		
	12 V DC	ARD15112C	ARD15112CQ	ARD55112C	ARD55112CQ		
	24 V DC	ARD15124C	ARD15124CQ	ARD55124C	ARD55124CQ		

■ Transfer

● Carton packing

Operating function	Rated coil voltage	Part No.				Standard packing	
		18 GHz		26.5 GHz		Inner carton	Outer carton
		No HF datasheet attached	HF datasheet attached	No HF datasheet attached	HF datasheet attached		
Fail-safe	4.5 V DC	ARD2004H	ARD2004HQ	ARD6004H	ARD6004HQ	1 pc.	10 pcs.
	12 V DC	ARD20012	ARD20012Q	ARD60012	ARD60012Q		
	24 V DC	ARD20024	ARD20024Q	ARD60024	ARD60024Q		
Latching	4.5 V DC	ARD2204H	ARD2204HQ	ARD6204H	ARD6204HQ		
	12 V DC	ARD22012	ARD22012Q	ARD62012	ARD62012Q		
	24 V DC	ARD22024	ARD22024Q	ARD62024	ARD62024Q		
Latching with TTL driver (with self cut-off function)	5 V DC	ARD25105	ARD25105Q	ARD65105	ARD65105Q		
	12 V DC	ARD25112	ARD25112Q	ARD65112	ARD65112Q		
	24 V DC	ARD25124	ARD25124Q	ARD65124	ARD65124Q		

■ SP6T

● Carton packing

Operating function	Rated coil voltage	Part No.		Standard packing	
		13 GHz		Inner carton	Outer carton
		No HF datasheet attached	HF datasheet attached		
Fail-safe	4.5 V DC	ARD3004H	ARD3004HQ	1 pc.	5 pcs.
	12 V DC	ARD30012	ARD30012Q		
	24 V DC	ARD30024	ARD30024Q		
Latching	4.5 V DC	ARD3204H	ARD3204HQ		
	12 V DC	ARD32012	ARD32012Q		
	24 V DC	ARD32024	ARD32024Q		

**RATING**

■ Coil data

• Operating characteristics such as 'Operate voltage' and 'Release voltage' are influenced by mounting conditions, ambient temperature, etc.

Therefore, please use the relay within  $\pm 5\%$  of rated coil voltage.

• 'Initial' means the condition of products at the time of delivery.

● SPDT

Fail-safe

Rated coil voltage	Rated operating current (+10%/-15%, at 20°C)		Rated operating power	
	With indicator	Without indicator	With indicator	Without indicator
4.5 V DC	186.7 mA	155.6 mA	840 mW	700 mW
12 V DC	70 mA	58.3 mA		
24 V DC	38.8 mA	29.2 mA	930 mW	

# Microwave Devices RD Coaxial switches

## Latching

Rated coil voltage	Rated operating current (+10%/-15%, at 20°C)		Rated operating power	
	With indicator	Without indicator	With indicator	Without indicator
4.5 V DC	133.3 mA	111.1 mA	600 mW	500 mW
12 V DC	50 mA	41.7 mA		
24 V DC	25.8 mA	16.7 mA	620 mW	

## Latching with TTL drive

Rated coil voltage	TTL logic level*		Self cut-off function	Switching frequency
	ON	OFF		
5 V DC	2.4 to 5.5 V (Square wave)	0 to 0.5 V (Square wave)	Available	Max.180 times/min (ON : OFF = 1 : 1)
12 V DC				
24 V DC				

\*Please see Operating voltage range

## ● Transfer

### Fail-safe

Rated coil voltage	Rated operating current (+10%/-15%, at 20°C)	Rated operating power
4.5 V DC	342.2 mA	1,540 mW
12 V DC	128.3 mA	
24 V DC	67.92 mA	1,630 mW

## Latching

Rated coil voltage	Rated operating current (+10%/-15%, at 20°C)	Rated operating power
4.5 V DC	244.4 mA	1,100 mW
12 V DC	91.7 mA	
24 V DC	46.7 mA	1,120 mW

## Latching with TTL driver

Rated coil voltage	TTL logic level*		Self cut-off function	Switching frequency
	ON	OFF		
5 V DC	4.5 to 5.5 V (Square wave)	0 to 0.5 V (Square wave)	Available	Max.180 times/min (ON : OFF = 1 : 1)
12 VDC				
24 V DC				

\*Please see Operating voltage range

## ● SP6T

### Fail-safe

Rated coil voltage	Rated operating current (+10%/-15%, at 20°C)	Rated operating power
4.5 V DC	186.7 mA	840 mW
12 V DC	70 mA	
24 V DC	38.8 mA	930 mW

## Latching

Rated coil voltage	Rated operating current (+10%/-15%, at 20°C)	Rated operating power
4.5 V DC	SET 133.3 mA/RESET (ALL) 800 mA	SET 600 mW/RESET (ALL) 3,600 mW
12 V DC	SET 50.0 mA/RESET (ALL) 300 mA	
24 V DC	SET 25.8mA/RESET (ALL) 155 mA	SET 620 mW/RESET (ALL) 3,720 mW

■ Operating voltage range

1. Fail-safe



2. Latching



3. Latching with TTL driver (with self cut-off function)



4. TTL Logic level range

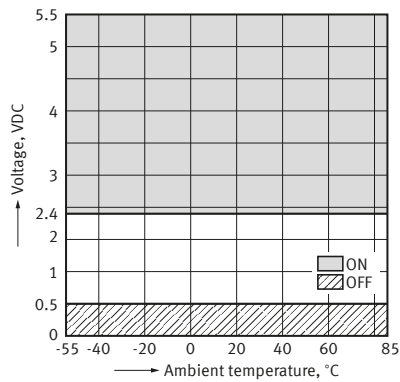

Note : Please consult us for use that is outside this range.

# SPDT and Transfer

## Specifications

Item		Specifications	
Contact data	Contact arrangement	SPDT	Transfer
	Contact resistance (initial)	Max. 100 mΩ (by voltage drop 6 V DC 1 A)	
	Contact material	Au plating	
	Contact input power (CW)	Max. 120 W (at 40°C, 3 GHz, 50 Ω, V.S.W.R. Max. 1.15, no contact switching)	Max. 120 W (at 25°C, 3 GHz, 50 Ω, V.S.W.R. Max. 1.15, no contact switching)
Indicator rating*1	Contact resistance (initial)	Max. 1 Ω (at 5 V 100 mA)	
	Max. switching voltage	30 V DC	
	Max. switching current	100 mA	
Insulation resistance (initial)		Min. 1,000 MΩ (at 500 V DC, Measured portion is the same as the case of dielectric strength.)	
Dielectric strength (initial)	Between open contacts	500 V AC for 1 min (detection current: 10 mA)	
	Between contact and coil	500 V AC for 1 min (detection current: 10 mA)	
	Between contact and earth terminal	500 V AC for 1 min (detection current: 10 mA)	
	Between coil and earth terminal	500 V AC for 1 min (detection current: 10 mA)	
Time characteristics (initial)	Operate (Set) time	Max. 15 ms at rated coil voltage (at 20°C, without bounce)	Max. 20 ms at rated coil voltage (at 20°C, without bounce)
	Release (Reset) time	-	Max. 20 ms at rated coil voltage (at 20°C, without bounce)
	Operate bounce time	Max. 10 ms (at 20°C)	-
Shock resistance	Functional	500 m/s <sup>2</sup> (half-sine shock pulse: 11 ms, detection time: 10 μs)	
	Destructive	1,000 m/s <sup>2</sup> (half-sine shock pulse: 11 ms)	
Vibration resistance	Functional	10 to 55 Hz (at double amplitude of 3 mm, detection time: 10 μs)	
	Destructive	10 to 55Hz (at double amplitude of 5 mm)	
Expected life	Mechanical life (Cold switch)	6 GHz: Min. 10 <sup>6</sup> 18 and 26.5 GHz: Min. 5 x 10 <sup>6</sup> (switching frequency: 180 times/min)	Min. 5 x 10 <sup>6</sup> (switching frequency: 180 times/min)
Conditions	Conditions for usage, transport and storage*2	Ambient temperature: -55 to +85°C Humidity: 5 to 85% RH (Avoid icing and condensation)	
Unit weight		Approx. 50 g	Approx. 110 g

\*1. With indicator type only

\*2. For ambient temperature, please read "GUIDELINES FOR RELAY USAGE".

## Expected electrical life (hot switch)

Conditions: Switching frequency 20 times/min

Type	Load	Switching capacity	Number of operations
SPDT	18 and 26.5 GHz high frequency load	5 W (Up to 3 GHz, 50 Ω, V.S.W.R. Max. 1.2)	Min. 5 x 10 <sup>6</sup>
	Indicator	10 mA 5 V DC	Min. 5 x 10 <sup>6</sup>
	6 GHz high frequency load	5 W (Up to 3 GHz, 50 Ω, V.S.W.R. Max. 1.2)	Min. 10 <sup>6</sup>
	Indicator	10 mA 5 V DC	Min. 10 <sup>6</sup>
Transfer	High frequency load	5 W (Up to 3 GHz, 50 Ω, V.S.W.R. Max. 1.2)	Min. 5 x 10 <sup>6</sup>
	Indicator	10 mA 5 V DC	Min. 5 x 10 <sup>6</sup>

# SP6T

## Specifications

Item		Specifications
Contact data	Contact arrangement	SP6T
	Contact resistance (initial)	Max. 100 mΩ (by voltage drop 6 V DC 1 A)
	Contact material	Au plating
	Contact input power (CW)	Max. 120 W (at 25°C, 3 GHz, 50 Ω, V.S.W.R. Max. 1.15, no contact switching)
Indicator rating	Contact resistance (initial)	Max. 1 Ω (at 5 V 100 mA)
	Max. switching voltage	30 V DC
	Max. switching current	100 mA
Insulation resistance (initial)		Min. 1,000 MΩ (at 500 V DC, Measured portion is the same as the case of dielectric strength.)
Dielectric strength (initial)	Between open contacts	500 V AC for 1 min (detection current: 10 mA)
	Between contact and coil	500 V AC for 1 min (detection current: 10 mA)
	Between contact and earth terminal	500 V AC for 1 min (detection current: 10 mA)
	Between coil and earth terminal	500 V AC for 1 min (detection current: 10 mA)
Time characteristics (initial)	Operate (Set) time	Max. 20 ms at rated coil voltage (at 20°C, without bounce)
	Release (Reset) time	Max. 20 ms at rated coil voltage (at 20°C, without bounce)
Shock resistance	Functional	500 m/s <sup>2</sup> (half-sine shock pulse: 11 ms, detection time: 10 μs)
	Destructive	1,000 m/s <sup>2</sup> (half-sine shock pulse: 11 ms)
Vibration resistance	Functional	10 to 55 Hz (at double amplitude of 3 mm, detection time: 10 μs)
	Destructive	10 to 55Hz (at double amplitude of 5 mm)
Expected life	Mechanical life (Cold switch)	Min. 5 x 10 <sup>6</sup> (switching frequency: 180 times/min)
Conditions	Conditions for usage, transport and storage*	Ambient temperature: -55 to +85°C Humidity: 5 to 85% RH (Avoid icing and condensation)
Unit weight		Approx. 320 g

\*For ambient temperature, please read "GUIDELINES FOR RELAY USAGE".

## Expected electrical life (hot switch)

Conditions: Switching frequency 20 times/min

Type	Switching capacity	Number of operations
SP6T	Contact	5 W (Up to 3 GHz, 50 Ω, V.S.W.R. Max. 1.2)
	Indicator	10 mA 5 V DC

## REFERENCE DATA

### 1-1.High frequency characteristics (SPDT: 6 GHz)

Sample : ARD70012  
Measuring method : Measured with Agilent Technologies network analyzer(E8363B).



# Microwave Devices RD Coaxial switches

## 1-2.High frequency characteristics (SPDT: 18, 26.5 GHz)

Sample : ARD10012  
 Measuring method : Measured with Agilent Technologies network analyzer (HP8510).



## 1-3.High frequency characteristics (Transfer)

Sample : ARD60012  
 Measuring method : Measured with Agilent Technologies network analyzer (HP8510).



## 1-4.High frequency characteristics (SP6T)

Sample : ARD30012  
 Measuring method : Measured with Agilent Technologies network analyzer (HP8510).





**DIMENSIONS**

**CAD** The CAD data of the products with a "CAD" mark can be downloaded from our Website.

Unit: mm

**SPDT**

● Solder terminal

**CAD**



External dimensions

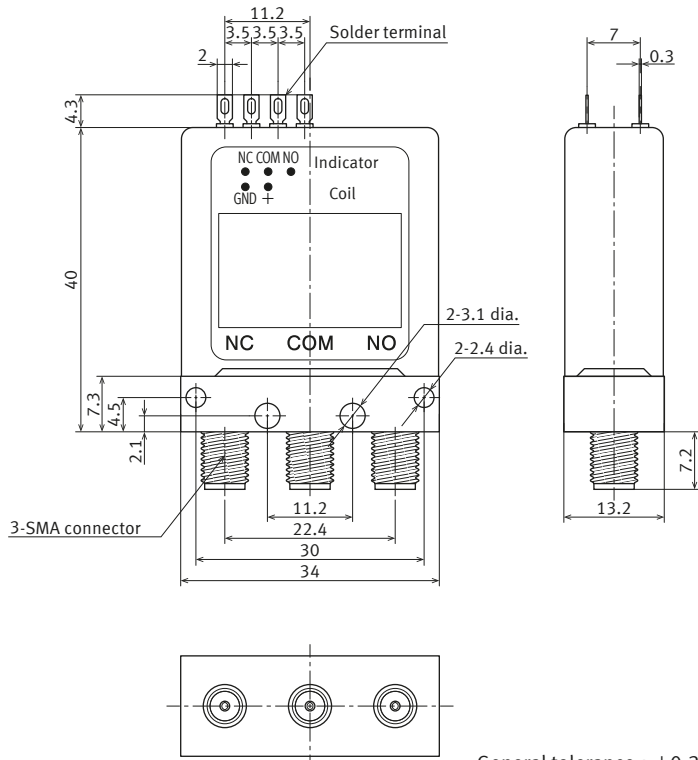

General tolerance : ±0.3

Solder terminal layout

Fail-safe

Latching

Latching with TTL driver  
(with self cut-off function)

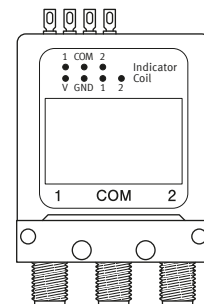
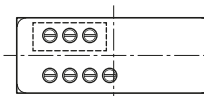
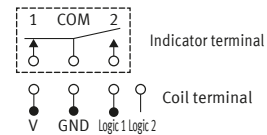
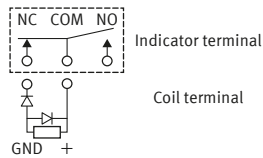

Note : 1. + COM type is available

2. The type without indicator terminals will not have the indicator terminals that are marked with the dotted box.

● Connector cable

**CAD**



External dimensions

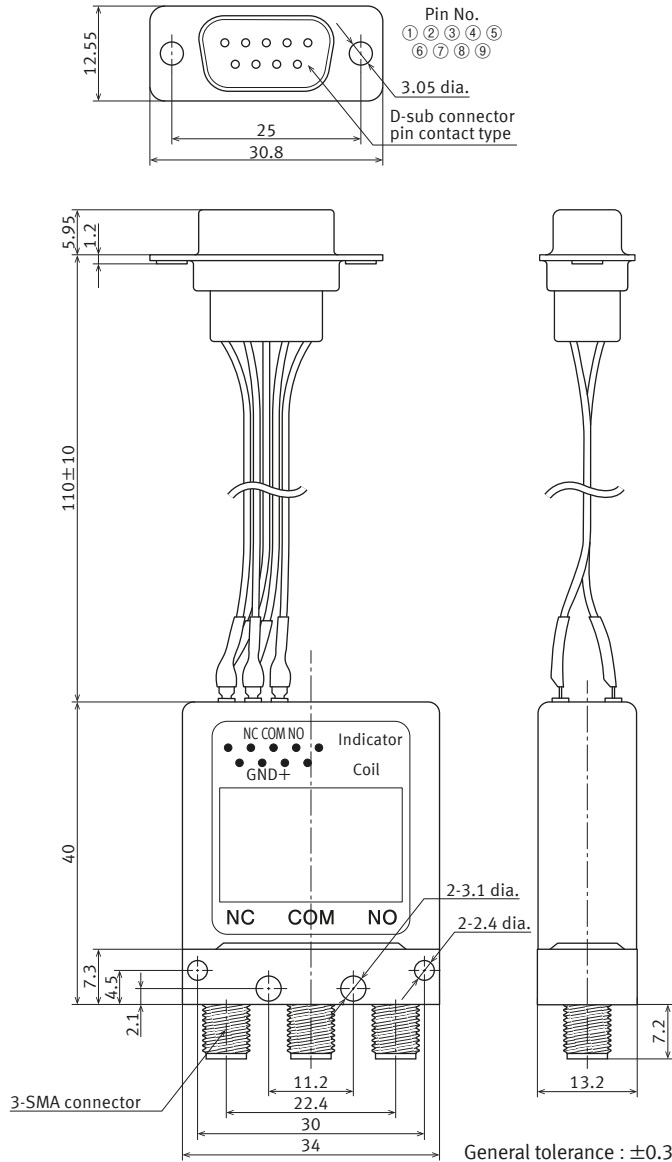

Solder terminal layout

Fail-safe

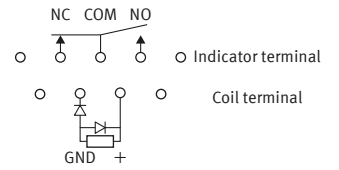

Note : + COM type is available

Latching

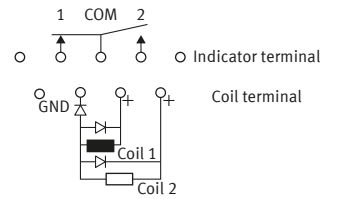

Latching with TTL driver (with self cut-off function)

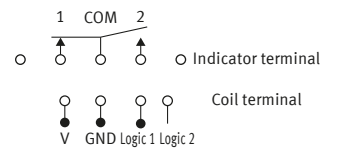

Pin layout

Pin No.	Indicator					Coil			
	1	2	3	4	5	6	7	8	9
Fail-safe	-	NC	COM	NO	-	-	GND	+	-
Latching	-	1	COM	2	-	-	GND	1	2
Latching with TTL driver	-	1	COM	2	-	V	GND	Logic 1	Logic 2

Transfer

CAD



External dimensions

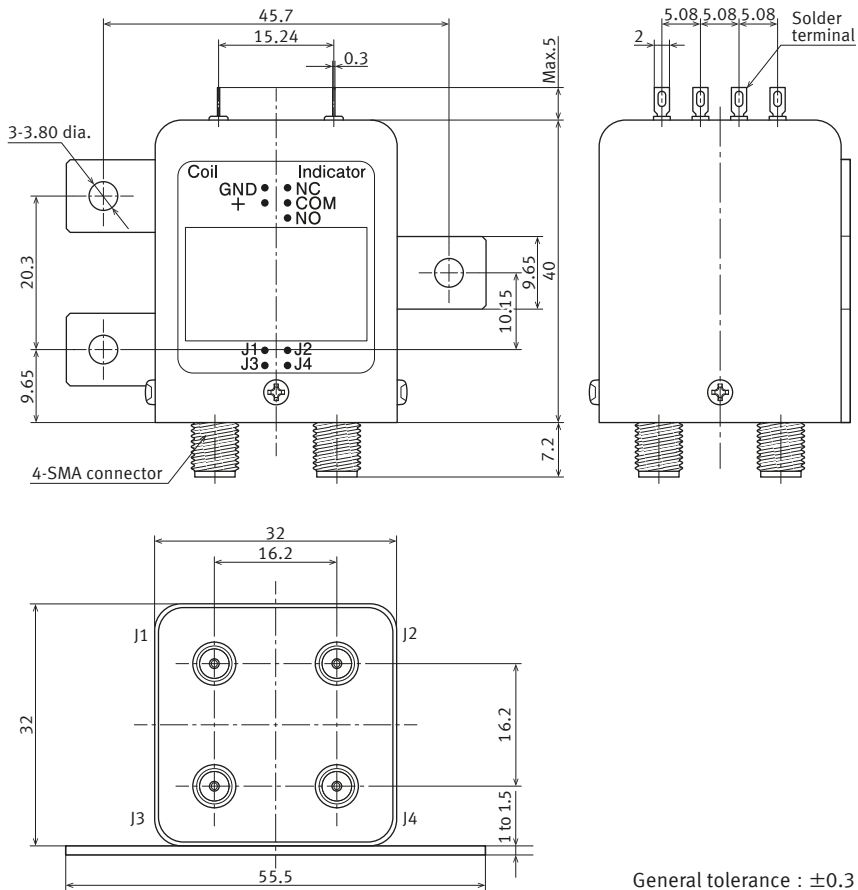

General tolerance : ±0.3

Connector layout and Schematic



Fail-safe	NC : J1-J2, J3-J4 NO : J1-J3, J2-J4
Latching	POS1 : J1-J2, J3-J4 POS2 : J1-J3, J2-J4
Latching with TTL driver	POS1 : J1-J2, J3-J4 POS2 : J1-J3, J2-J4

Fail-safe

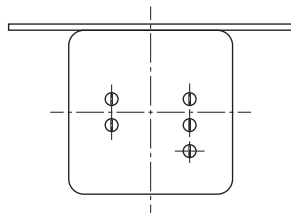
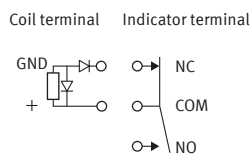

Solder terminal layout

Latching

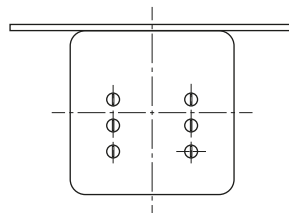
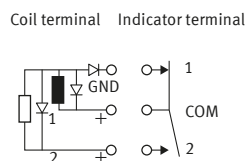

Latching with TTL driver  
(with self cut-off function)

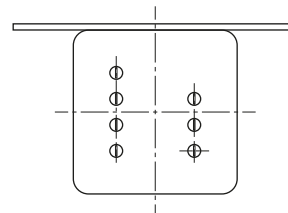
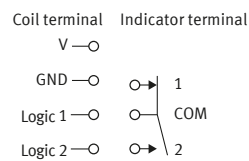

Note : + COM type is available

SP6T  
CAD



External dimensions



General tolerance : ±0.3

Solder terminal layout  
Fail-safe

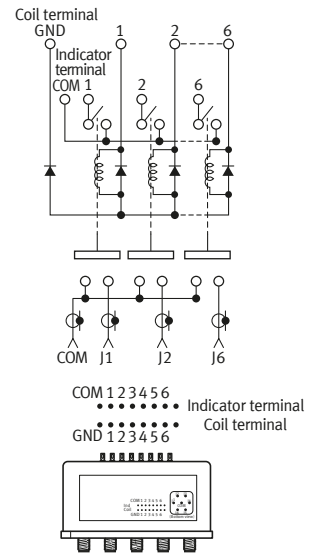

Note : + COM type is available.

Latching

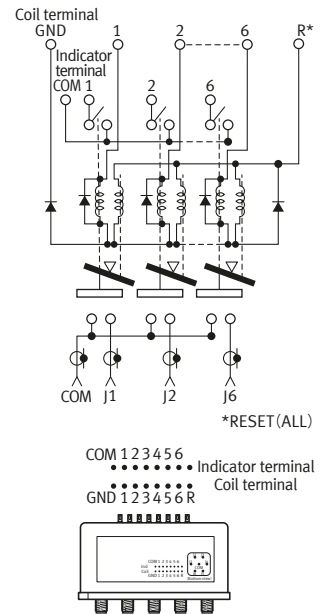

**AN EXAMPLE OF RECOMMENDED SOLDERING CONDITIONS**

■ For cautions for use, please read “Relay Soldering and Cleaning Guidelines”.

■ **Coil and indicator connector**

In case of hand soldering, the following conditions should be observed.

The effect on the coaxial switch depends on the PC board used. Please verify the actual PC board to be used.

● **Hand soldering**

Recommended conditions	Temperature	Time	Measurement location
Soldering	Max. 350°C	Within 3 seconds	Tip temperature

■ **Other things to observe**

- Exceeding the stipulated conditions when soldering may affect coaxial switch performance. Be sure to consult us beforehand.
- Creep-up, wettability and solder strength will differ depending on changes in the mounting conditions and type of solder. Please evaluate based on actual production conditions.
- This product cannot be cleaned.
- Only apply coating after the coaxial switch has returned to room temperature.

**GUIDELINES FOR USAGE**

■ For cautions for use, please read “GUIDELINES FOR MICROWAVE DEVICES USAGE” and “GUIDELINES FOR RELAY USAGE”.

■ **Cautions for usage of RD coaxial switches**

● **Latching**

- We recommend latching type when using in applications which involve lengthy duty cycles.
- Regarding the set and reset pulse time, for the purpose of reliable operation under ambient temperature fluctuations and different operating conditions, we recommend setting the coil applied set and reset pulse time to 50 ms or more at the rated coil voltage.
- The latching type relay is shipped in the reset position. But jolts during transport or impacts during installation can change the reset position. It is, therefore, advisable to build a circuit in which the relay can be initialized (set and reset) just after turning on the power.

● **Others**

- For SMA connectors, we recommend a torque of  $0.90 \pm 0.1$  N·m for installation, which falls within the prescribed torque of MIL-C-39012.
- Please be aware that conditions might be different depending on the connector materials and how it interacts with surrounding materials.
- SP6T: Latching  
Please note that when switching contacts, you must apply RESET (ALL) voltage and release all contacts first.
- SP6T  
Do not use multiple contacts simultaneously.
- The indicator terminal is the terminal that indicates the operation status of the MAIN contact.
- Due to the possibility of coaxial switch malfunction, do not energize the set and reset coils simultaneously.

## CONDITIONS FOR USE

### ■ Conditions for operation, transport and storage conditions

During usage, storage, or transportation, avoid locations subject to direct sunlight and maintain normal temperature, humidity, and pressure conditions.

#### ● Temperature and humidity

When transporting or storing relays while they are tube packaged, there are cases when the temperature may differ from the allowable range. In this situation, be sure to consult the individual specifications.

The humidity range varies with the temperature. Use within the range indicated in the graph. (The allowable temperature depends on the relays.)



Please refer to **"the latest product specifications"** when designing your product.

•Requests to customers:

<https://industrial.panasonic.com/ac/e/salespolicies/>

# GUIDELINES FOR MICROWAVE DEVICES USAGE

For cautions for use, please read "GUIDELINES FOR RELAY USAGE".

[https://industrial.panasonic.com/ac/e/control/relay/cautions\\_use/index.jsp](https://industrial.panasonic.com/ac/e/control/relay/cautions_use/index.jsp)

## Precautions for Coil Input

### ■ Long term current carrying

A circuit that will be carrying a current continuously for long periods without relay or microwave device switching operation. (circuits for emergency lamps, alarm devices and error inspection that, for example, revert only during malfunction and output warnings with form B contacts) Continuous, long-term current to the coil will facilitate deterioration of coil insulation and characteristics due to heating of the coil itself.

For circuits such as these, please use a magnetic-hold type latching relay. If you need to use a single stable relay, use a sealed type relay that is not easily affected by ambient conditions and make a failsafe circuit design that considers the possibility of contact failure or disconnection.

### ■ DC Coil operating power

Steady state DC current should be applied to the coil. The wave form should be rectangular. If it includes ripple, the ripple factor should be less than 5%.

However, please check with the actual circuit since the electrical characteristics may vary. The rated coil voltage should be applied to the coil and the set/reset pulse time of latching type relay differs for each relays, please refer to the relay's individual specifications.

### ■ Coil connection

When connecting coils of polarized relays, please check coil polarity (+,-) at the internal connection diagram (Schematic). If any wrong connection is made, it may cause unexpected malfunction, like abnormal heat, fire and so on, and circuit do not work. Avoid impressing voltages to the set coil and reset coil at the same time.

### ■ Maximum allowable voltage and temperature rise

Proper usage requires that the rated coil voltage be impressed on the coil. Note, however, that if a voltage greater than or equal to the maximum continuous voltage is impressed on the coil, the coil may burn or its layers short due to the temperature rise. Furthermore, do not exceed the usable ambient temperature range listed in the catalog.

#### ● Maximum allowable voltage for coil

In addition to being a requirement for relay operation stability, the maximum continuous impressed coil voltage is an important constraint for the prevention of such problems as thermal deterioration or deformity of the insulation material, or the occurrence of fire hazards.

## Ambient Environment

### ● Dew condensation

Condensation occurs when the ambient temperature drops suddenly from a high temperature and humidity, or the relay and microwave device is suddenly transferred from a low ambient temperature to a high temperature and humidity. Condensation causes the failures like insulation deterioration, wire disconnection and rust etc.

Panasonic Corporation does not guarantee the failures caused by condensation.

The heat conduction by the equipment may accelerate the cooling of device itself, and the condensation may occur.

Please conduct product evaluations in the worst condition of the actual usage. (Special attention should be paid when high temperature heating parts are close to the device. Also please consider the condensation may occur inside of the device.)

### ● Icing

Condensation or other moisture may freeze on relays when the temperature become lower than 0°C. This icing causes the sticking of movable portion, the operation delay and the contact conduction failure etc. Panasonic Corporation does not guarantee the failures caused by the icing.

The heat conduction by the equipment may accelerate the cooling of relay itself and the icing may occur. Please conduct product evaluations in the worst condition of the actual usage.

### ● Temperature rise due to pulse voltage

When a pulse voltage with ON time of less than 2 minutes is used, the coil temperature rise bears no relationship to the ON time. This varies with the ratio of ON time to OFF time, and compared with continuous current passage, it is rather small. The various relays are essentially the same in this respect.

Current passage time	(%)
For continuous passage	Temperature rise value is 100%
ON : OFF = 3 : 1	About 80%
ON : OFF = 1 : 1	About 50%
ON : OFF = 1 : 3	About 35%

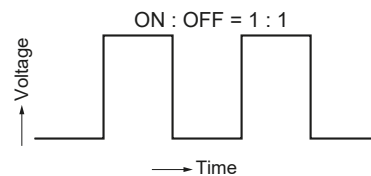

### ■ Operate voltage change due to coil temperature rise (Hot start)

In DC relays, after continuous passage of current in the coil, if the current is turned OFF, then immediately turned ON again, due to the temperature rise in the coil, the pick-up voltage will become somewhat higher. Also, it will be the same as using it in a higher temperature atmosphere. The resistance/temperature relationship for copper wire is about 0.4% for 1°C, and with this ratio the coil resistance increases. That is, in order to operate of the relay, it is necessary that the voltage be higher than the pick-up voltage and the pick-up voltage rises in accordance with the increase in the resistance value. However, for some polarized relays, this rate of change is considerably smaller.

### ● Low temperature and low humidity

The plastic becomes brittle if the switch is exposed to a low temperature, low humidity environment for long periods of time.

### ● High temperature and high humidity

Storage for extended periods of time (including transportation periods) at high temperature or high humidity levels or in atmospheres with organic gases or sulfide gases may cause a sulfide film or oxide film to form on the surfaces of the contacts and/or it may interfere with the functions. Check out the atmosphere in which the units are to be stored and transported.

### ● Package

In terms of the packing format used, make every effort to keep the effects of moisture, organic gases and sulfide gases to the absolute minimum.

# GUIDELINES FOR MICROWAVE DEVICES USAGE

## ●Storage requirements

Since the SMD type is sensitive to humidity it is packaged with tightly sealed anti-humidity packaging. However, when storing, please be careful of the following.

1) Please use promptly once the anti-humidity pack is opened. (within 72 hours, Max. 30°C/70% R.H.). If left with the pack open, the relay will absorb moisture which will cause thermal stress when reflow mounting and thus cause the case to expand. As a result, the seal may break.

\*For RE relays, after this bag is opened, the product must be used within 24 hours.

2) If relays will not be used within 72 hours, please store relays in a humidity controlled desiccator or in an anti-humidity bag to which silica gel has been added.

\*If the relay is to be soldered after it has been exposed to excessive humidity atmosphere, cracks and leaks can occur. Be sure to mount the relay under the required mounting conditions

\*For RE relays, after this bag is opened, the product must be used within 24 hours.

3) The following cautionary label is affixed to the anti-humidity pack.

## ●Silicon

When a source of silicone substances (silicone rubber, silicone oil, silicone coating materials and silicone filling materials etc.) is used around the relay, the silicone gas (low molecular siloxane etc.) may be produced.

This silicone gas may penetrate into the inside of the relay. When the relay is kept and used in this condition, silicone compound may adhere to the relay contacts which may cause the contact failure. Do not use any sources of silicone gas around the relay (Including plastic seal types).

## ●NOx Generation

When relay is used in an atmosphere high in humidity to switch a load which easily produces an arc, the NOx created by the arc and the water absorbed from outside the relay combine to produce nitric acid. This corrodes the internal metal parts and adversely affects operation. Avoid use at an ambient humidity of 85%RH or higher (at 20°C). If use at high humidity is unavoidable, please contact our sales representative.

\*RE Relays only

**C a u t i o n**

This vacuum-sealed bag contains

**Moisture Sensitive Products**

After this bag is opened, the product must be used

**within 7 2 h o u r s**

If product is not used within 72 hours, baking is necessary.

For baking conditions please contact us.

**C a u t i o n**

This vacuum-sealed bag contains

**Moisture Sensitive Products**

After this bag is opened, the product must be used

**within 2 4 h o u r s**

If product is not used within 24 hours, baking is necessary.

For baking conditions please contact us.

## Others

### ■Cleaning

1) Although the environmentally sealed type relay (plastic sealed type, etc.) can be cleaned, avoid immersing the relay into cold liquid (such as cleaning solvent) immediately after soldering. Doing so may deteriorate the sealing performance.

2) Surface mount terminal type relay is sealed type and it can be cleaned by immersion. Use pure water or alcohol-based cleaning solvent.

3) Cleaning with the boiling method is recommended (The temperature of cleaning liquid should be 40°C or lower).

Avoid ultrasonic cleaning on relays. Use of ultrasonic cleaning may cause breaks in the coil or slight sticking of the contacts due to the ultrasonic energy.

### ■Other handling precautions

• Expected switching life is defined under the standard test conditions (temperature 15 to 35°C, humidity: 25 to 75%) specified in JIS C 5442.

Expected switching life is depend on usage conditions; coil driving circuit, load type, activation frequency, activation phase, ambient conditions and other factors. Please check relays and microwave devices on the actual circuit.

Also, pay special attention loads such as those listed below.

• When used for AC load-operating and the operating phase is synchronous, rocking and fusing can easily occur due to contact shifting.

• Frequent switching under load condition

When high frequently switched under load condition that can cause arc at the contacts, nitrogen and oxygen in the air is fused by the arc energy and HNO<sup>3</sup> is formed. This can corrode metal materials. Countermeasures for these are.

1. Incorporate an arc-extinguishing circuit.
2. Lower the operating frequency
3. Lower the ambient humidity

• When used for "Dry switching" without load current, please contact our sales representative.

• Please avoid relays to be used outside of the specification ranges such as the coil rating, contact rating and switching life that may cause abnormal heating, smoke, and fire.

• In case relays and microwave devices are dropped, please do not use.

Please refer to "**the latest product specifications**" when designing your product.

•Requests to customers:

<https://industrial.panasonic.com/ac/e/salespolicies/>



---

Please contact .....

**Panasonic Corporation**

Electromechanical Control Business Division

■1006, Oaza Kadoma, Kadoma-shi, Osaka 571-8506, Japan  
[industrial.panasonic.com/ac/e/](http://industrial.panasonic.com/ac/e/)

**Panasonic**<sup>®</sup>

©Panasonic Corporation 2020