

## ◆ MAJOR USES

- AC/DC Common mode filter

## ◆ FEATURES

- Compared to conventional coils, the inductance level (100kHz) has been significantly improved.
- Compared to conventional coils, a higher impedance level has been realized within wide ranges of frequencies.
- Conforming to insulating type B and incombustibility UL94V-0

## ◆ CORE STANDARD SPECIFICATIONS

Coil Part No. *1	Core Part No.	Rated voltage [V]	Rated Current [A]	Inductance		D.C.R. mΩ (max)	Winding mm φ × lines	Outside Dimensions			Frequency Characteristics Graph	Temperature rise Graph
				10kHz [mH]	100kHz [mH]			D1 [mm]	D2 [mm]	W [mm]		
LDFL004272VS-□0E	F110705	250	3.5	6.0	2.7	38	0.55×1P	15.0	16.0	12.0	1,2	A
LDFL006102VS-□0E			5.5	2.3	1.0	16	0.7×1P					
LDFL006832VD-□0E	F221407	250	5.5	18.3	8.3	26	0.9×1P	27.0	31.0	17.5	3,4	B
LDFL009412VD-□0E			9	9.1	4.1	16	1.1×1P					
LDFL012282VD-□0E			12	6.2	2.8	9.5	1.3×1P					
LDFL014172VD-□0E			14	3.8	1.7	7	1.4×1P					
LDFL007652V6-□0E	F221310	250	7	16.3	6.5	22	1.0×1P	29.0	31.0	21.0	5,6	C
LDFL010302V6-□0E			10	6.7	3.0	11	1.2×1P					
LDFL012202V6-□0E			12	4.5	2.0	7.5	1.3×1P					
LDFL008123VV-□0E	F251513	250	8	25.3	11.5	26	1.1×1P	30.5	34.0	23.5	7,8	D
LDFL011742VV-□0E			11	16.2	7.4	15	1.3×1P					
LDFL013412VV-□0E			13	9.1	4.1	12	1.4×1P					
LDFL015372VBU□0E	F281815	700	15	8.1	3.7	6.7	1.7×1P	36.0	40.0	29.5	9,10	E
LDFL021252VBU□0E			21	5.4	2.5	4.5	1.9×1P					
LDFL026152VBU□0E			26	3.3	1.5	2.9	1.5×2P					
LDFL020592VJU□0E	F372315	700	20	12.9	5.9	5.7	1.5×2P	48.0	50.0	32.5	11,12	F
LDFL027282VJU□0E			27	6.2	2.8	3.1	1.7×2P					
LDFL039172VJU□0E			39	3.7	1.7	1.5	2.0×2P					

\*1 For Coil Part No., vertical type=V, horizontal type=H are used

Frequency Characteristics Ambient temperature : 25°C

Graph-1 (VS)

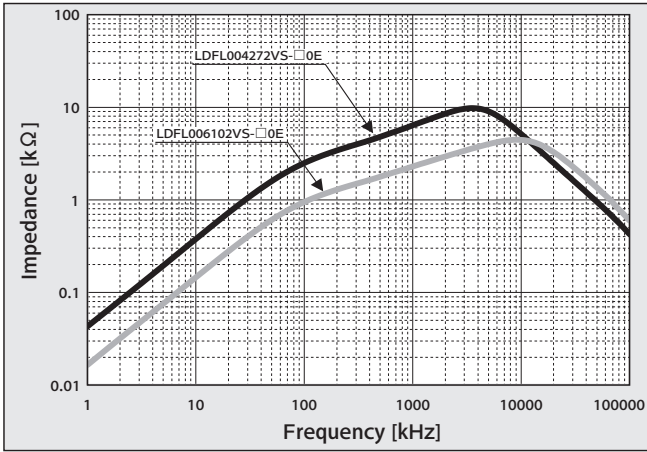

Graph-2 (VS)

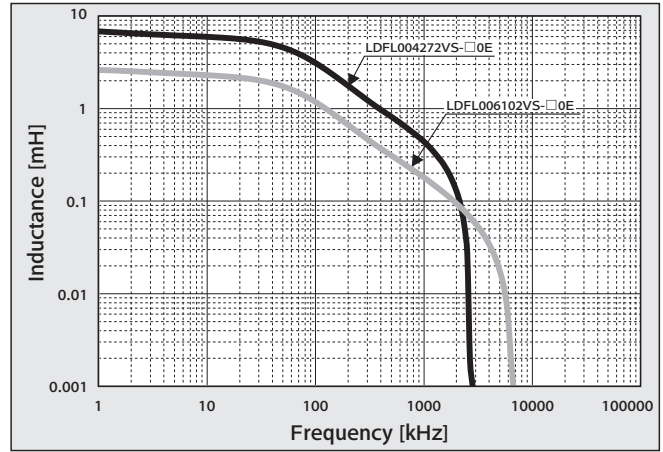

Graph-3 (VD)

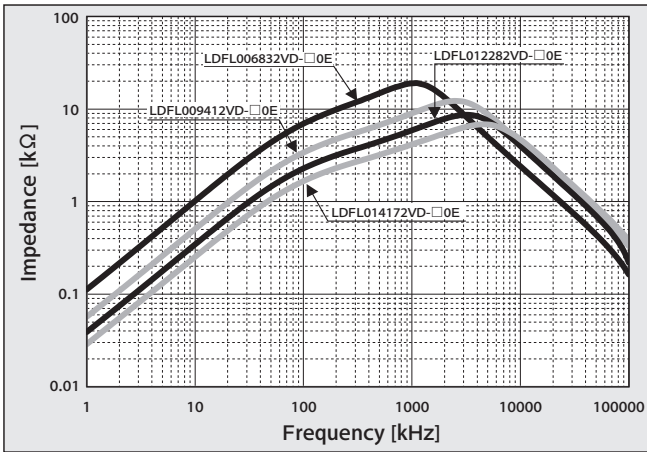

Graph-4 (VD)

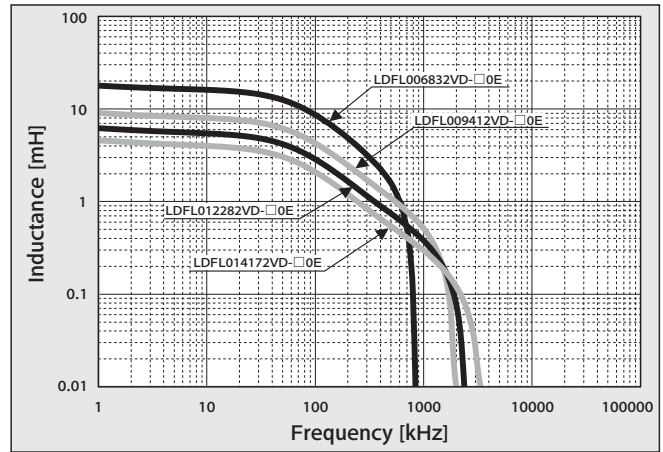

Graph-5 (V6)

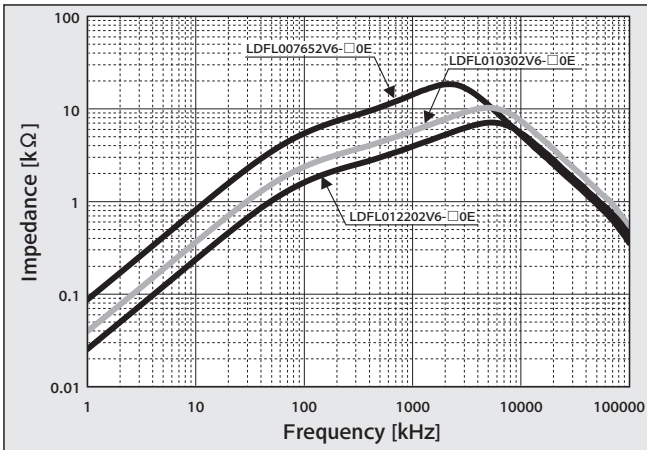

Graph-6 (V6)

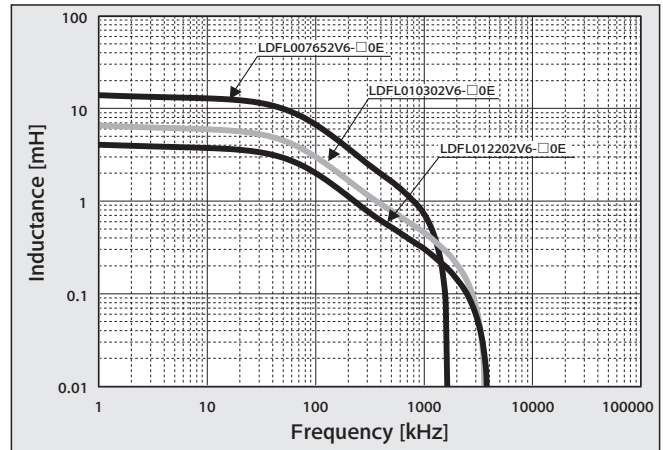

Frequency Characteristics Ambient temperature : 25°C

Graph-7 (VV)

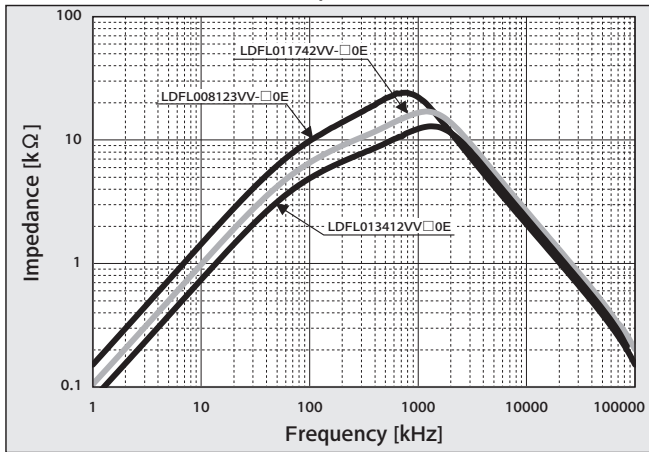

Graph-8 (VV)

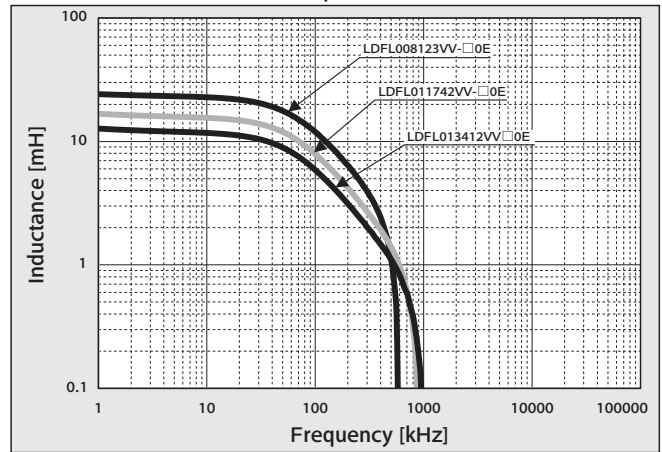

Graph-9 (VBU)

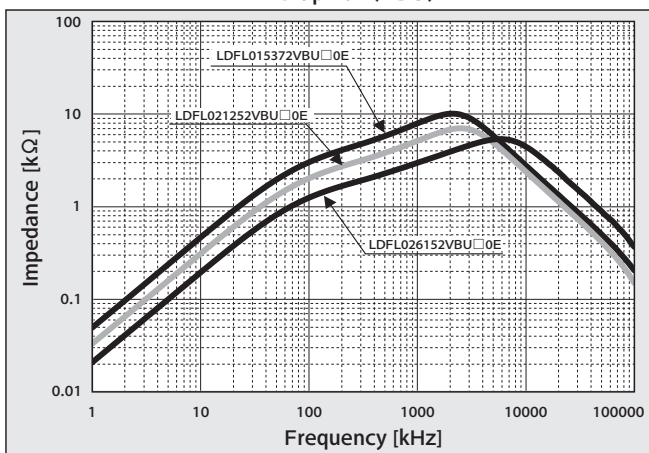

Graph-10 (VBU)

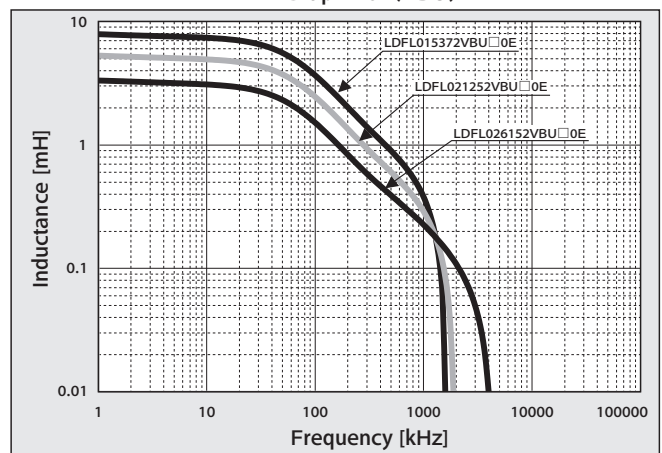

Graph-11 (VJU)

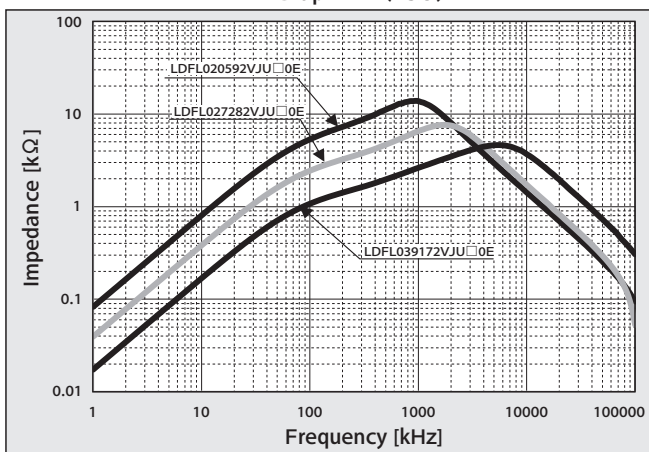

Graph-12 (VJU)

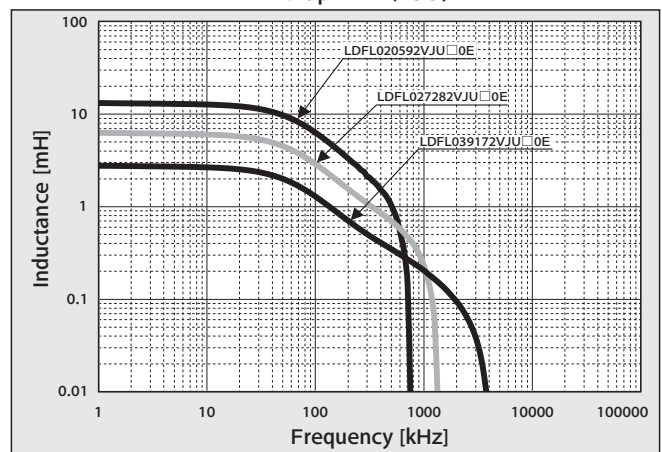

Temperature rise Ambient temperature: 25°C (calm) Saturation temperature for the DC current flow  
 \* Installation conditions or the influence of heat emitted by surrounding components are not considered in this data.

Graph-A (VS)

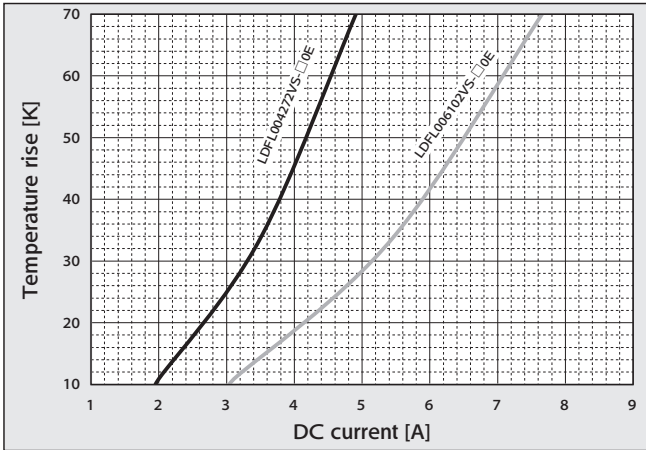

Graph-B (VD)

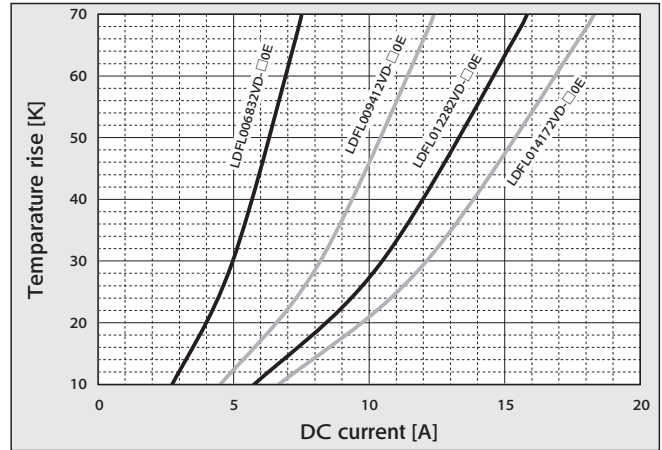

Graph-C (V6)

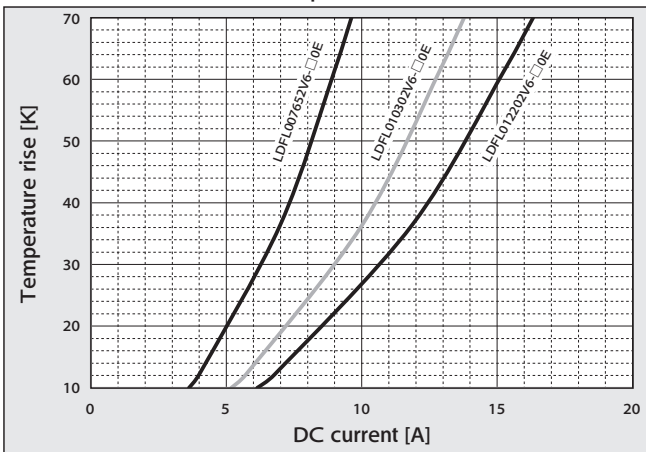

Graph-D (VV)

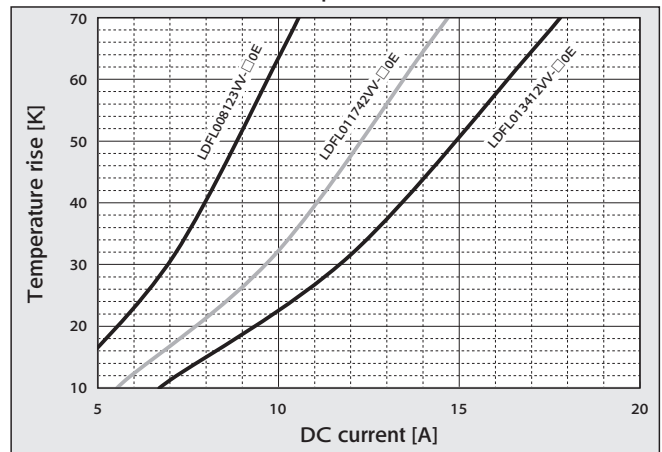

Graph-E (VBU)

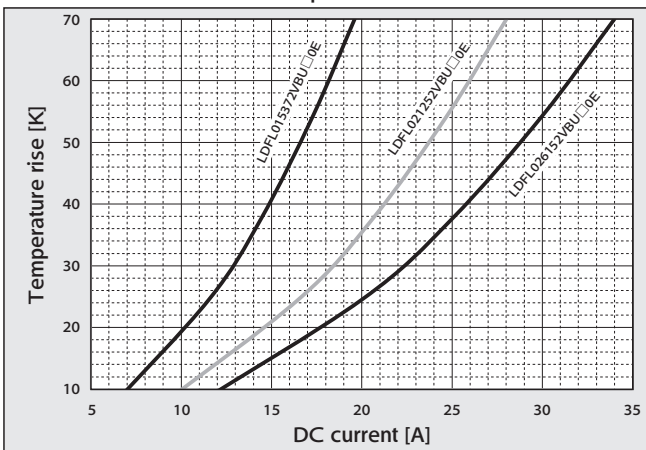

Graph-F (VJU)

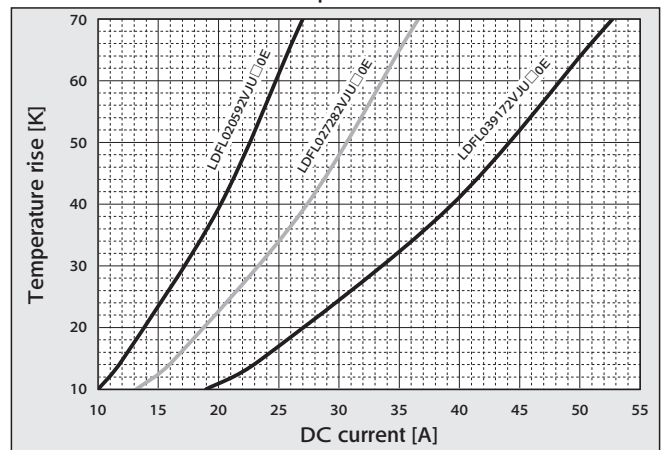

## FL Series

Standard type for single phase

### ◆ MAJOR USES

- Common mode coils for noise filter in inverter or large capacity power supply

### ◆ FEATURES

- Small profile, light through adoption of high permeability core
- High inductance in spite of a small number of turns
- Low temperature rise and low D.C. resistance
- Stable frequency performance of noise suppression in wide frequency range
- Excellent temperature characteristics

### ◆ COIL STANDARD SPECIFICATIONS

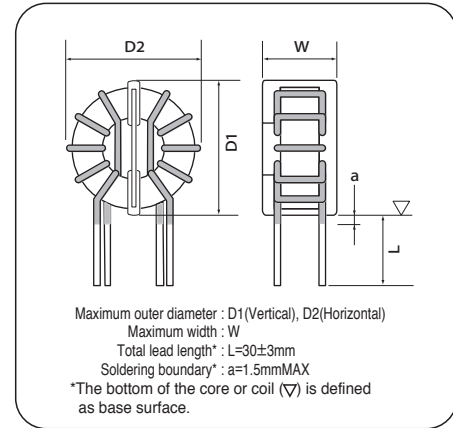

Coil Part No. (Old Coil Part No.)	Rated Current A	Inductance		D.C.R. mΩ (max)	Winding mm φ × lines	Outside Dimensions		
		10kHz (Typical) mH	100kHz (Rating) mH			D1 mm	D2 mm	W mm
● LDFL001802LS-V0E (FL01393LSPBF)	1	28.0	8.0	200	0.35 × 1P	15.0	16.0	11.9
● LDFL002302LS-V0E (FL02173LSPBF)	2	11.6	3.0	85	0.45 × 1P	15.0	16.0	11.9
● LDFL003152LS-V0E (FL03872LSPBF)	3	5.6	1.5	45	0.55 × 1P	15.0	16.0	11.9
LDFL003552L5-V0E (FL03552L5PBF)	3	22.0	5.5	56	0.7 × 1P	28.0	29.0	15.0
LDFL003153L6-V0E (FL03153L6PBF)	3	60.0	15.0	82	0.7 × 1P	29.0	30.5	20.5
LDFL005132L5-V0E (FL05132L5PBF)	5	5.4	1.3	16	1.0 × 1P	29.0	30.0	15.0
LDFL005332L6-V0E (FL05332L6PBF)	5	13.0	3.3	21	1.0 × 1P	29.0	30.5	20.0
LDFL005302LT-V0E (FL05302LTPBF)	5	13.0	3.0	17	1.1 × 1P	34.0	36.0	20.0
LDFL005502LT-V0E (FL05502LTPBF)	5	23.0	5.0	23	1.1 × 1P	34.5	36.5	20.5
LDFL005103LR-V0E (FL05103LRPBF)	5	39.0	10.0	33	1.1 × 1P	39.0	41.0	25.5
LDFL008451L5-V0E (FL08451L5PBF)	8	1.8	0.45	6.5	1.3 × 1P	29.5	31.0	15.0
LDFL008102L6-V0E (FL08102L6PBF)	8	4.2	1.0	9	1.3 × 1P	29.5	31.5	20.5
LDFL010102LT-V0E (FL10102LTPBF)	10	5.8	1.0	8	1.5 × 1P	34.0	38.0	22.0
LDFL010302LT-V0E (FL10302LTPBF)	10	13.0	3.0	11	1.4 × 1P	36.0	38.0	22.0
LDFL010502LR-V0E (FL10502LRPBF)	10	24.0	5.0	15	1.5 × 1P	40.0	43.0	27.0
LDFL010103LJ-V0E (FL10103LJPBF)	10	46.5	10.0	20	1.5 × 1P	46.5	47.5	27.5
LDFL015102LT-V0E (FL15102LTPBF)	15	3.7	1.0	6	1.6 × 1P	34.5	38.0	20.5
LDFL015302LR-V0E (FL15302LRPBF)	15	15.0	3.0	10	1.8 × 1P	40.0	42.5	29.0
LDFL015502LJ-V0E (FL15502LJPBF)	15	24.8	5.0	11	1.8 × 1P	47.0	49.0	28.0
LDFL020102LR-V0E (FL20102LRPBF)	20	4.2	1.0	5	1.5 × 2P	42.5	43.0	28.0
LDFL020302LJ-V0E (FL20302LJPBF)	20	13.5	3.0	7	1.5 × 2P	46.5	48.0	30.0
LDFL025252LJ-V0E (FL25252LJPBF)	25	11.6	2.5	5	1.6 × 2P	47.0	49.0	31.0
LDFL030102LR-V0E (FL30102LRPBF)	30	4.2	1.0	5	1.7 × 2P	39.5	44.0	29.5
LDFL030202LJ-V0E (FL30202LJPBF)	30	9.9	2.0	6	1.7 × 2P	47.0	48.5	31.0

The total lead length of the items marked with ● is 15±3mm.



◆FREQUENCY - IMPEDANCE CHARACTERISTICS (1)  
●Rated Current: 1, 2, 3 [A]

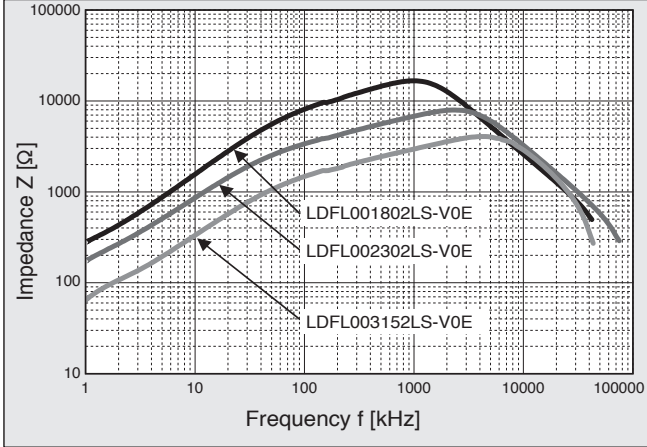

◆FREQUENCY - IMPEDANCE CHARACTERISTICS (2)  
●Rated Current: 3, 5 [A]

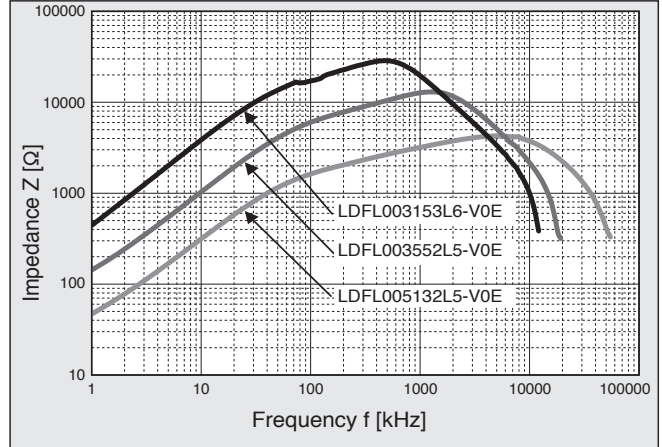

◆FREQUENCY - IMPEDANCE CHARACTERISTICS (3)  
●Rated Current: 5 [A]

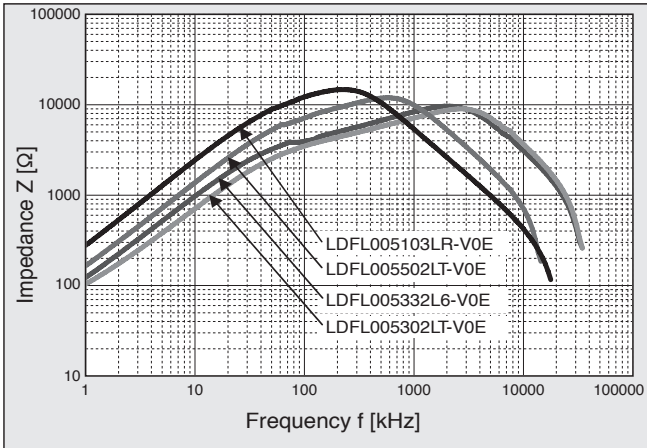

◆FREQUENCY - IMPEDANCE CHARACTERISTICS (4)  
●Rated Current: 8, 10 [A]

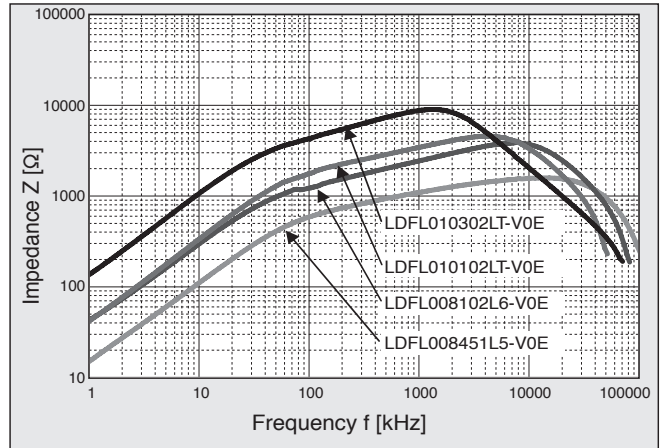

◆FREQUENCY - IMPEDANCE CHARACTERISTICS (5)  
●Rated Current: 10, 15 [A]

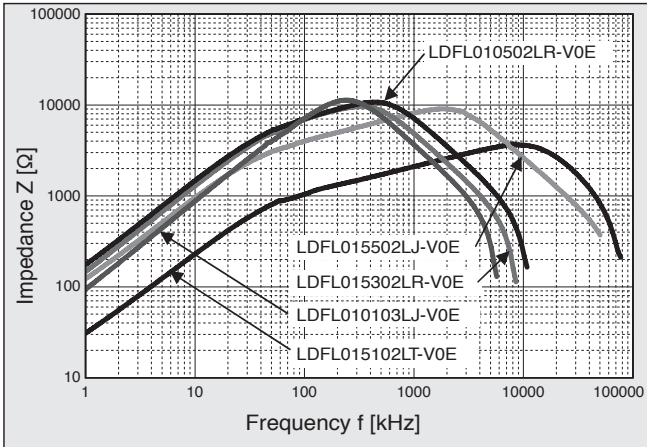

◆FREQUENCY - IMPEDANCE CHARACTERISTICS (6)  
●Rated Current: 20, 25, 30 [A]

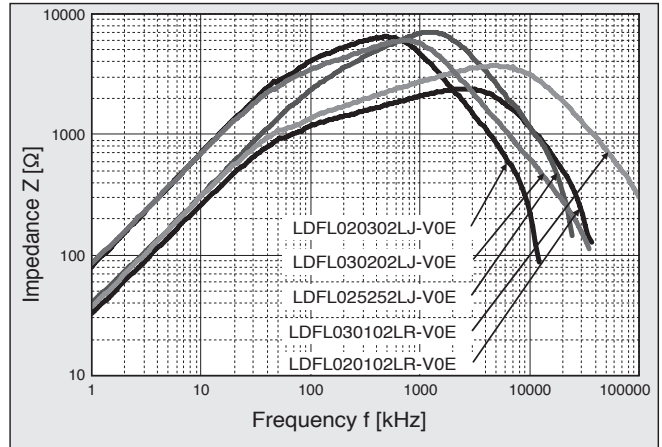

◆FREQUENCY - INDUCTANCE CHARACTERISTICS (1)

●Rated Current: 1, 2, 3 [A]

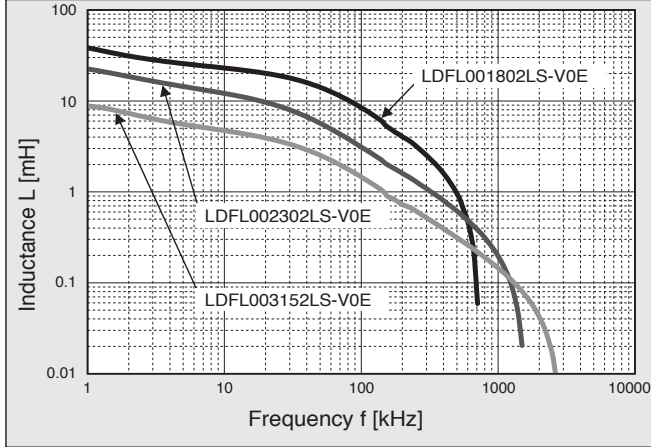

◆FREQUENCY - INDUCTANCE CHARACTERISTICS (2)

●Rated Current: 3, 5 [A]

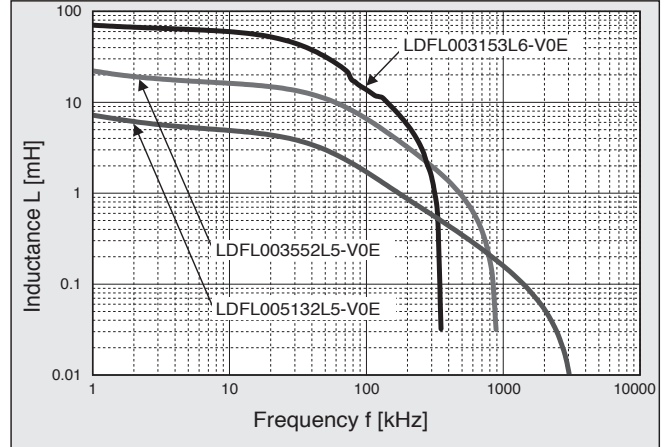

◆FREQUENCY - INDUCTANCE CHARACTERISTICS (3)

●Rated Current: 5 [A]

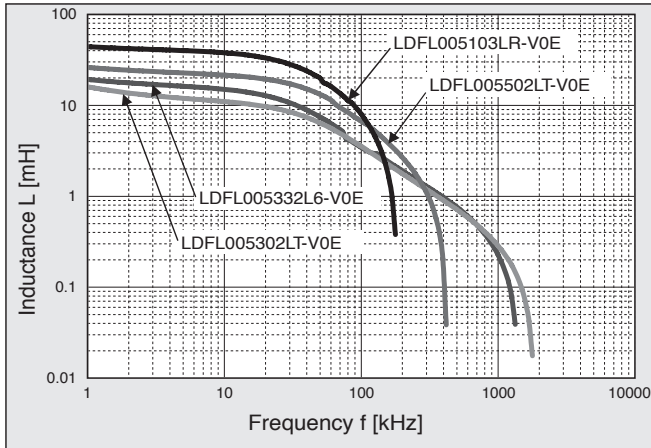

◆FREQUENCY - INDUCTANCE CHARACTERISTICS (4)

●Rated Current: 8, 10 [A]

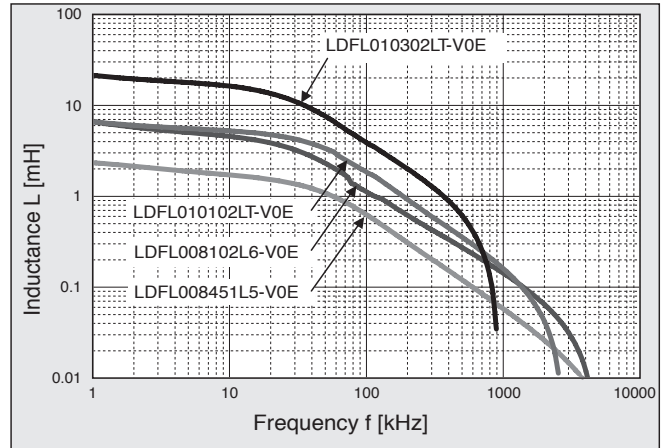

◆FREQUENCY - INDUCTANCE CHARACTERISTICS (5)

●Rated Current: 10, 15 [A]

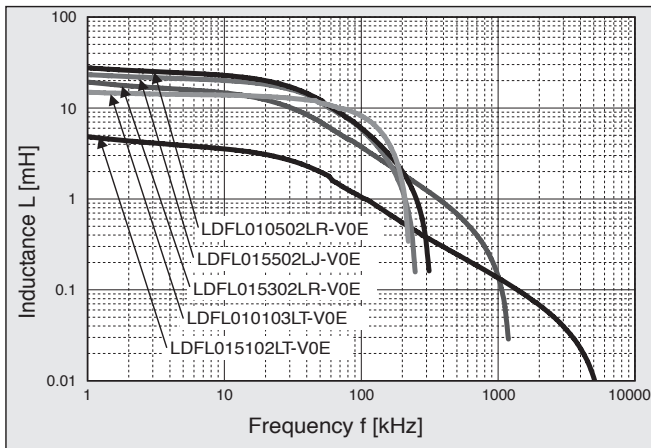

◆FREQUENCY - INDUCTANCE CHARACTERISTICS (6)

●Rated Current: 20, 25, 30 [A]

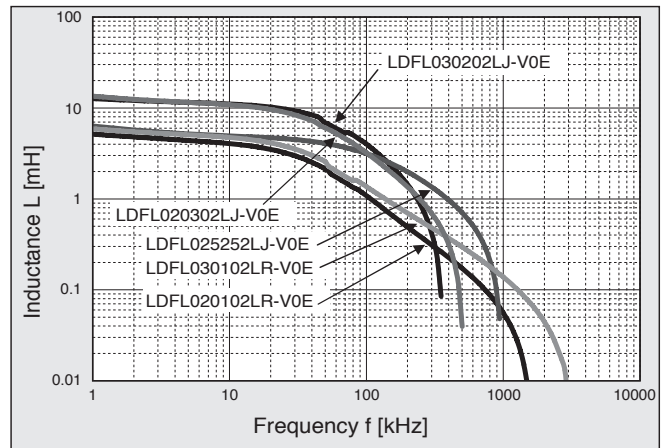

## FL Series

High voltage type for single phase

### ◆ MAJOR USES

- Common mode coils for noise filter in inverter or large capacity power supply

### ◆ FEATURES

- Applicable to input voltage (700V)
- Remarkably miniaturized in profile benefited by high permeability core
- High inductance in spite of a small number of turns
- Low temperature rise and low D.C. resistance
- Stable frequency performance of noise suppression in wide frequency range
- Excellent temperature characteristics

### ◆ COIL STANDARD SPECIFICATIONS

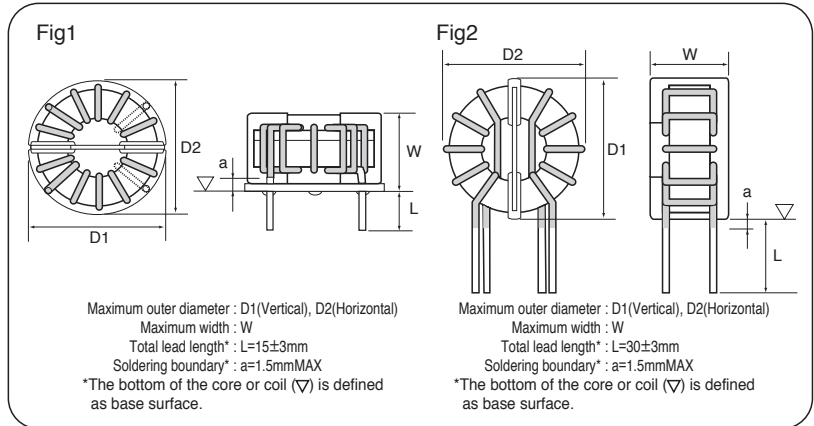

Coil Part No. (Old Coil Part No.)	Rated Current A	Inductance		D.C.R. mΩ (max)	Winding mm φ × lines	Outside Dimensions			
		10kHz (Typical)	100kHz (Rating)			D1 mm	D2 mm	W mm	Dimensions
		mH	mH						
<b>LDFL010402LBUB0E</b> (FL10402LBUBPBF)	10	16.0	4.0	12	1.5 × 1P	42.0	42.0	32.0	Fig1
<b>LDFL015132LBUB0E</b> (FL15132LBUBPBF)	15	5.1	1.3	6	1.9 × 1P	42.0	42.0	32.5	Fig1
<b>LDFL020342LJUV0E</b> (FL20342LJUPBF)	20	13.5	3.4	8	1.4 × 2P	49.0	49.0	31.0	Fig2
<b>LDFL025252LJUV0E</b> (FL25252LJUPBF)	25	9.9	2.5	6	1.6 × 2P	50.0	50.0	32.0	Fig2

LDFL010402LBUB0E, LDFL015132LBUB0E listed in the above table are coils of lying type with pedestal.  
For LDFL020342LJUV0E, LDFL025252LJUV0E, lying type is also available. "V" changes into "H" in last the third digit of the name of items.

### ◆ FREQUENCY - IMPEDANCE CHARACTERISTICS

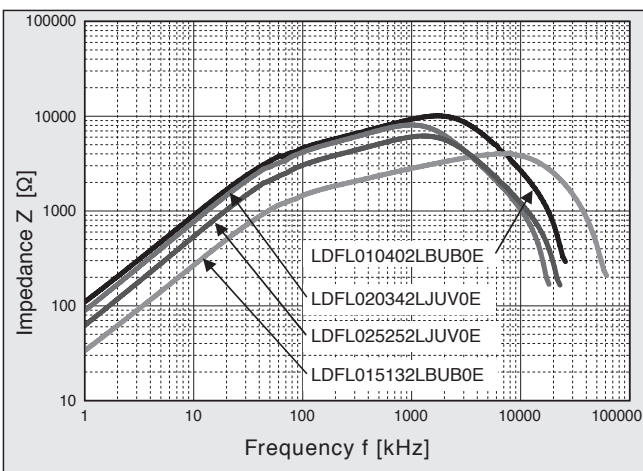

### ◆ FREQUENCY - INDUCTANCE CHARACTERISTICS

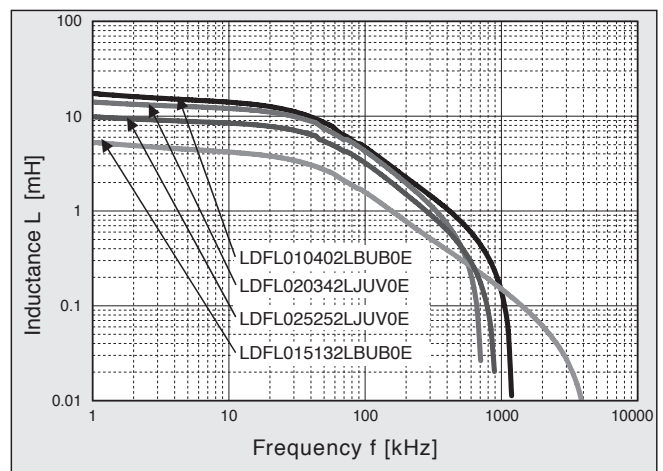



For three-phase circuit

◆ **MAJOR USES**

- Common mode coils for noise filter in inverter or large capacity power supply

◆ **FEATURES**

- Compared to conventional coils, the inductance level (100kHz) has been significantly improved.
- Compared to conventional coils, a higher impedance level has been realized within wide ranges of frequencies.
- Conforming to insulating type B and incombustibility UL94V-0

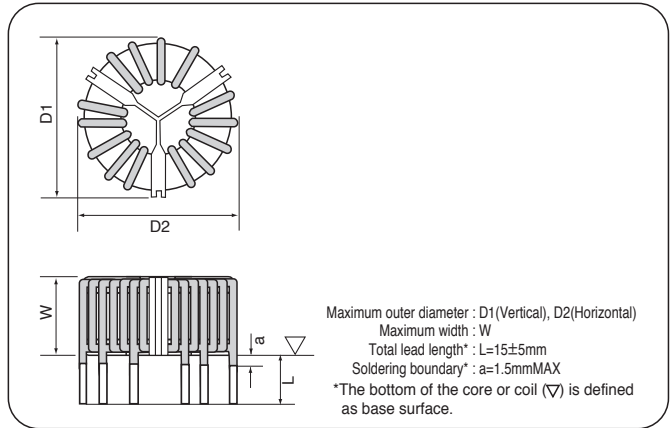

◆ **CORE STANDARD SPECIFICATIONS**

Coil Part No. (Old Coil Part No.)	Rated Current A	Inductance		D.C.R. mΩ (max)	Winding mm φ × lines	Outside Dimensions		
		10kHz (Typical)	100kHz (Rating)			D1 mm	D2 mm	W mm
		mH	mH					
LDFL010143VNQH0E (FL10143VNQPBF)	10	30.7	14.0	18	1.5 × 1P	56.0	56.0	32.0
LDFL020502VNQH0E (FL20502VNQPBF)	20	11.1	5.0	6	2.0 × 1P	56.0	56.0	32.0
LDFL015163VGQH0E (FL15163VGQPBF)	15	34.5	15.7	15	2.0 × 1P	65.0	65.0	35.0
LDFL020792VGQH0E (FL20792VGQPBF)	20	17.3	7.9	6	2.3 × 1P	65.0	65.0	35.0
LDFL025542VGQH0E (FL25542VGQPBF)	25	11.7	5.4	5	1.8 × 2P	65.0	65.0	35.0
LDFL030332VGQH0E (FL30332VGQPBF)	30	7.2	3.3	4	2.0 × 2P	65.0	65.0	35.0

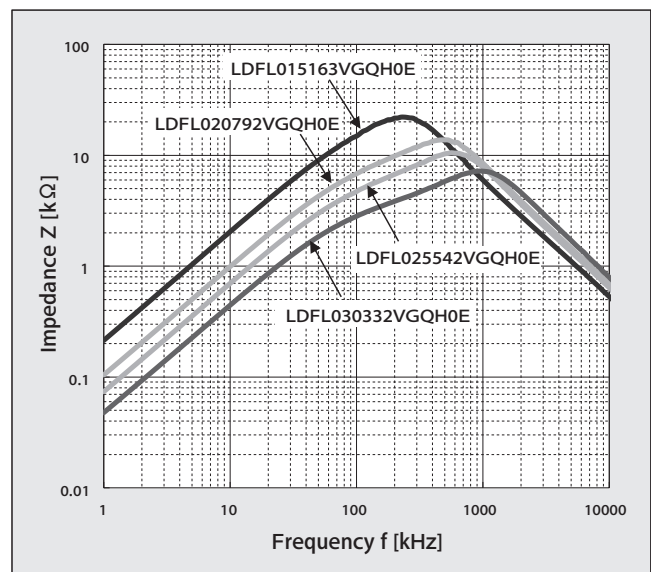
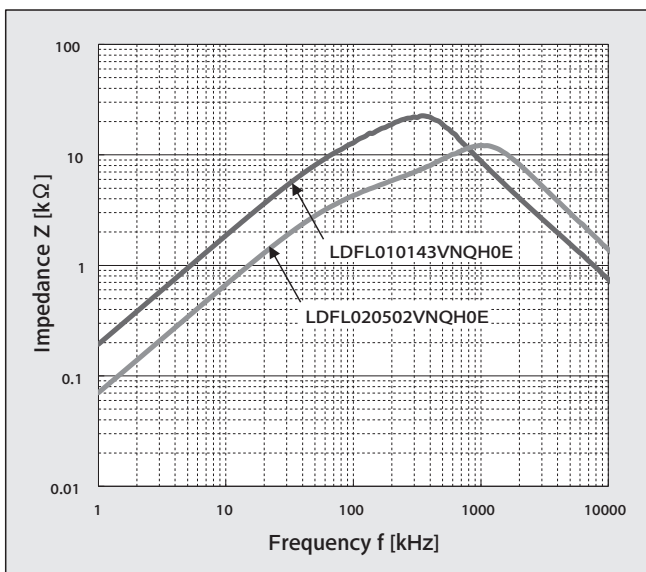

**FL Series**

For three-phase circuit

◆ **MAJOR USES**

- Common mode coils for noise filter in inverter or large capacity power supply

◆ **FEATURES**

- Small profile, light through adoption of high permeability core
- High inductance in spite of a small number of turns
- Low temperature rise and low D.C. resistance
- Stable frequency performance of noise suppression in wide frequency range
- Excellent temperature characteristics
- Conforming to insulating type B and incombustibility UL94V-0

Coil Part No. (Old Coil Part No.)	Rated Current A	Inductance		D.C.R. mΩ (max)	Winding mm φ × lines	Outside Dimensions		
		10kHz (Typical)	100kHz (Rating)			D1 mm	D2 mm	W mm
		mH	mH					
<b>LDL010822LNQH0E</b> (FL10822LNQPBF)	10	27.0	8.2	18	1.5 × 1P	56.0	56.0	32.0
<b>LDL020302LNQH0E</b> (FL20302LNQPBF)	20	11.0	3.0	6	2.0 × 1P	56.0	56.0	32.0
<b>LDL015802LGQH0E</b> (FL15802LGQPBF)	15	30.0	8.0	15	2.0 × 1P	65.0	65.0	35.0
<b>LDL020402LGQH0E</b> (FL20402LGQPBF)	20	16.0	4.0	6	2.3 × 1P	65.0	65.0	35.0
<b>LDL025282LGQH0E</b> (FL25282LGQPBF)	25	10.0	2.8	5	1.8 × 2P	65.0	65.0	35.0
<b>LDL030172LGQH0E</b> (FL30172LGQPBF)	30	7.0	1.7	4	2.0 × 2P	65.0	65.0	35.0

◆ **COIL STANDARD SPECIFICATIONS**

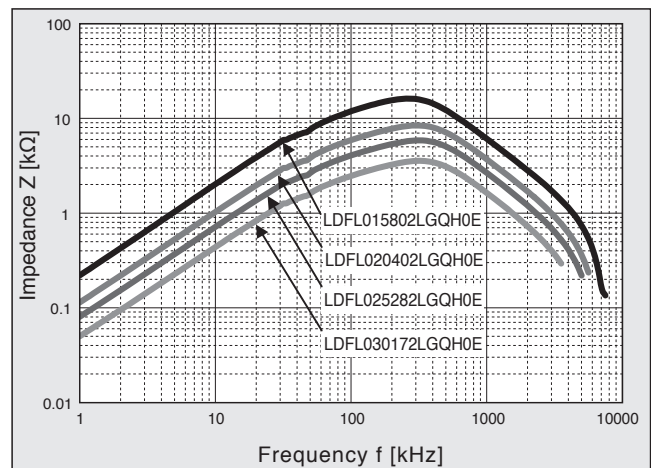
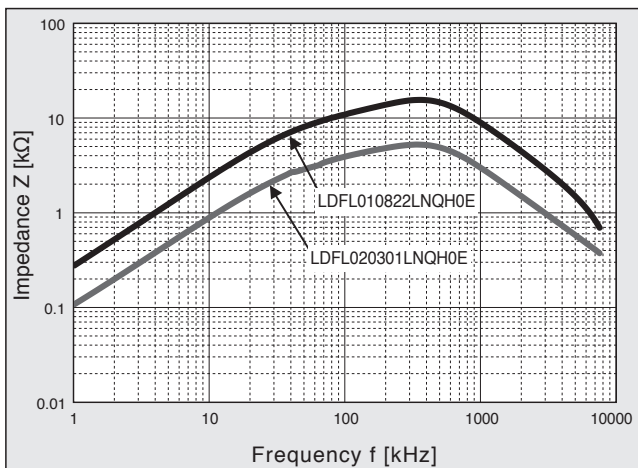

### ◆ MAJOR USES

- Signal power line noise control
- DC power line noise control
- AC power line noise control
- Zero-phase reactor

### ◆ FEATURES

- Compared to conventional series, a higher impedance level has been realized within wide ranges of frequencies.
- Conforming to insulating type B and incombustibility UL94V-0

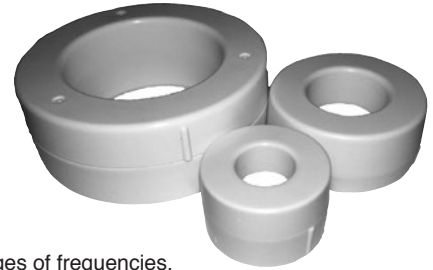

### ◆ CORE STANDARD SPECIFICATIONS

Core Part No.	Cross Sectional Area cm <sup>2</sup>	Magnetic Path Length cm	Weight g	Nominal dimensions			Inductance Coefficient (AL Value) [μH] 100kHz at 0A
				φD mm	φd mm	W mm	
LRF251510MKCX	0.41	6.38	21	28.3	12.7	12.3	25.2
LRF251515MKCX	0.63	6.38	32	28.3	12.7	17.5	38.1
LRF322015MKCX	0.69	8.09	60	35.2	17.5	17.3	33.1
LRF372315MKCX	0.83	9.33	80	40.5	19.5	18.0	34.7
LRF462715MKCX	1.14	11.47	98	49.4	22.7	18.0	38.7
LRF462725MKCX	1.90	11.47	162	49.4	22.7	28.0	64.6
LRF624520MKCX	1.36	16.81	173	66.0	41.0	24.0	31.5

### ◆ DIMENSIONS OF CORE

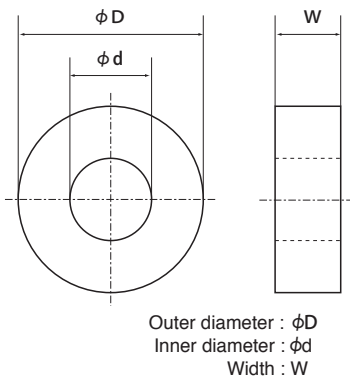

◆ FREQUENCY - IMPEDANCE CHARACTERISTICS

● LRF251510MKCX

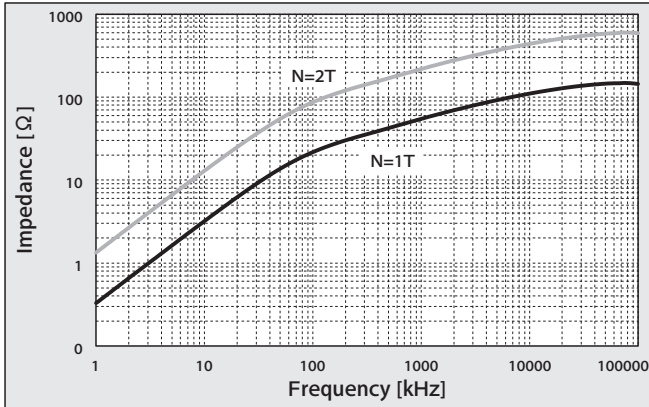

● LRF251515MKCX

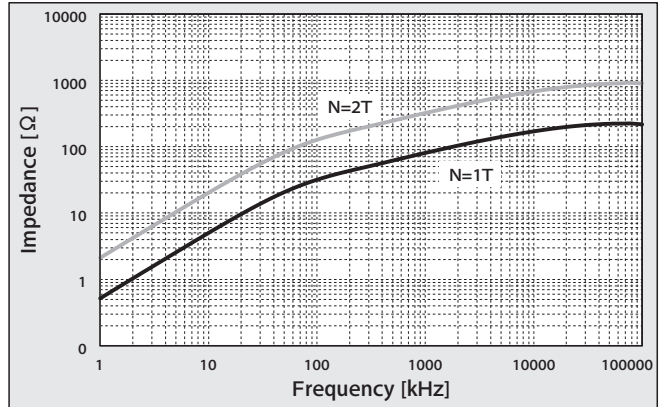

● LRF322015MKCX

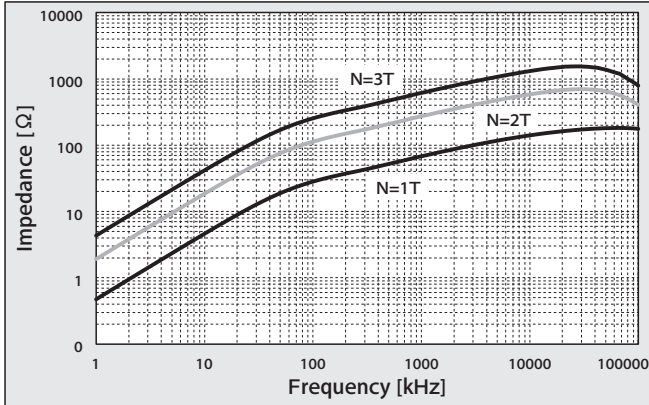

● LRF372315MKCX

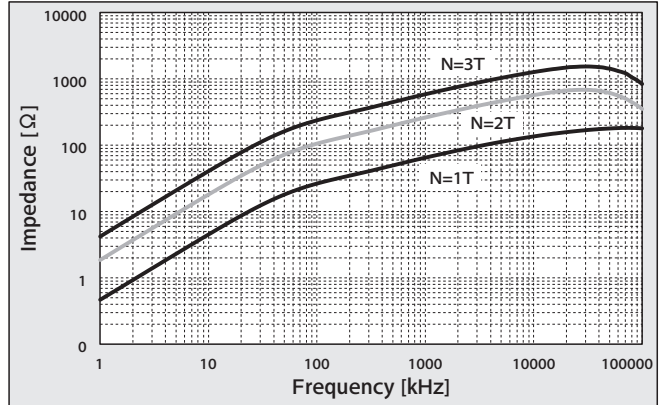

● LRF462715MKCX

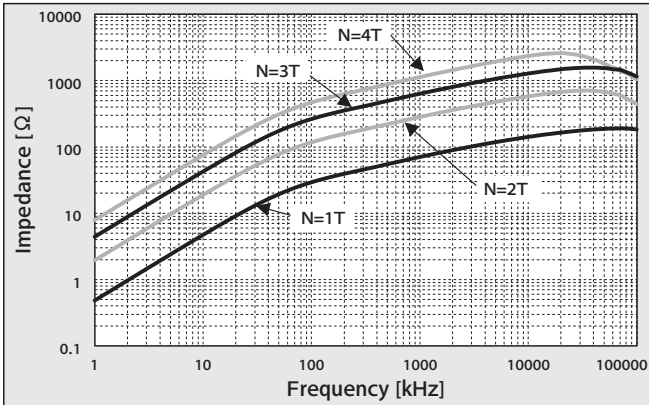

● LRF462725MKCX

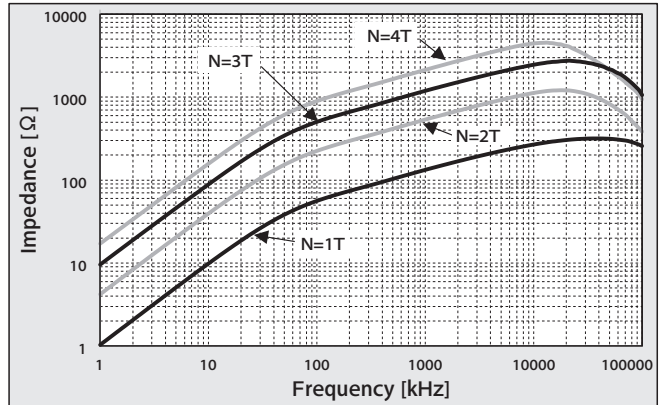

● LRF624520MKCX

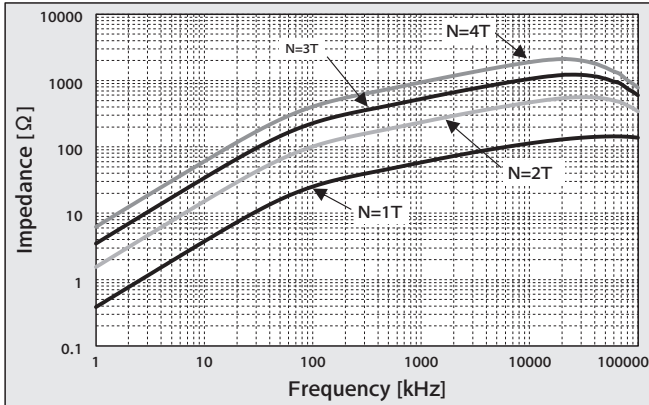

The FM series coils are made of nano-crystal.



### ◆ MAJOR USES

- Signal power line noise control
- DC power line noise control
- AC power line noise control
- Filter line
- Zero-phase reactor

### ◆ FEATURES

- The high permeability core is made of nanocrystalline soft magnetic alloy
- High impedance in spite of a small number of turns
- Excellent temperature characteristics
- Conforming to insulating type B and incombustibility UL94V-0

### ◆ CORE STANDARD SPECIFICATIONS

Core Part No. (Old Core Part No.)	Cross Sectional Area cm <sup>2</sup>	Magnetic Path Length cm	Weight g	Outside Dimensions			Inductance Coefficient (AL Value) [μH/100kHz at 0A]
				φD mm	φd mm	W mm	
LRF251515MKX (F251515MKX)	0.63	6.40	35	28.3	12.7	17.5	18.3
LRF322015MKX (F322015MKX)	0.73	8.17	50	35.2	17.5	17.3	16.6
LRF372315MKX (F372315MKX)	0.85	9.42	67	40.5	19.5	18.0	17.2
LRF462715MKX (F462715MKX)	1.15	11.50	110	49.4	22.7	18.0	18.6
LRF462725MKX (F462725MKX)	1.92	11.50	176	49.4	22.7	28.0	31.0
LRF603525MKX (F603525MKX)	2.53	14.90	310	66.7	29.3	29.2	31.6
LRF624520MKX (F624520MKX)	1.36	16.80	200	66.0	41.0	24.0	15.2

### ◆ DIMENSIONS OF CORE

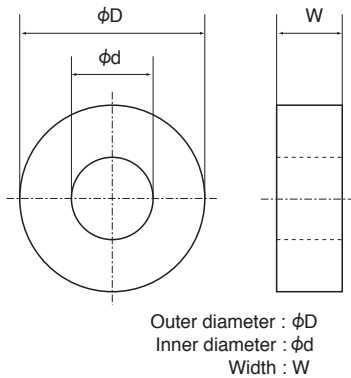

### ◆ FREQUENCY - PERMEABILITY CHARACTERISTICS

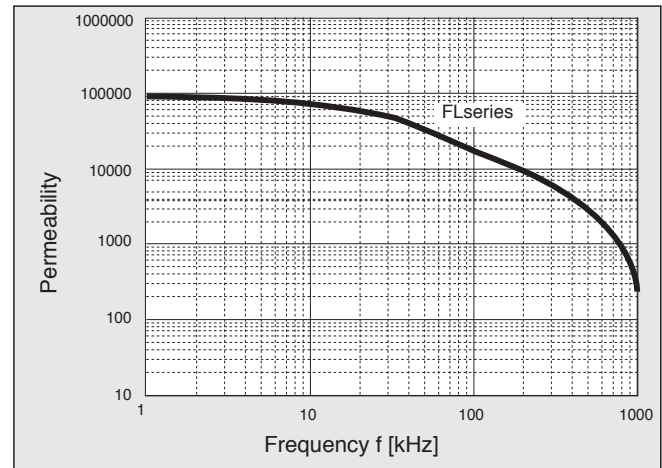



◆FREQUENCY - IMPEDANCE CHARACTERISTICS (1)

●LRF251515MKX

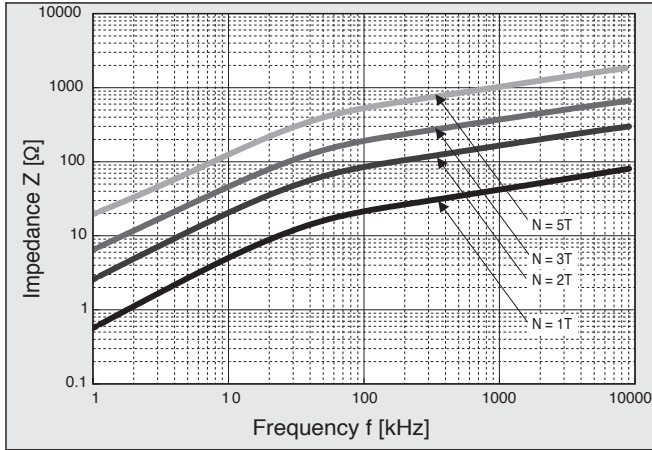

◆FREQUENCY - IMPEDANCE CHARACTERISTICS (2)

●LRF322015MKX

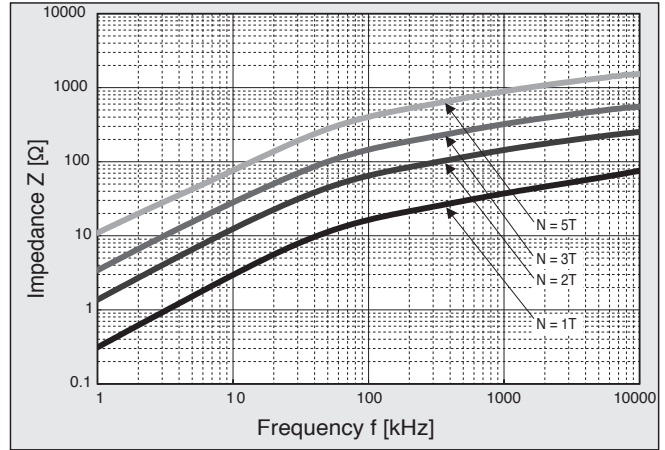

◆FREQUENCY - IMPEDANCE CHARACTERISTICS (3)

●LRF372315MKX

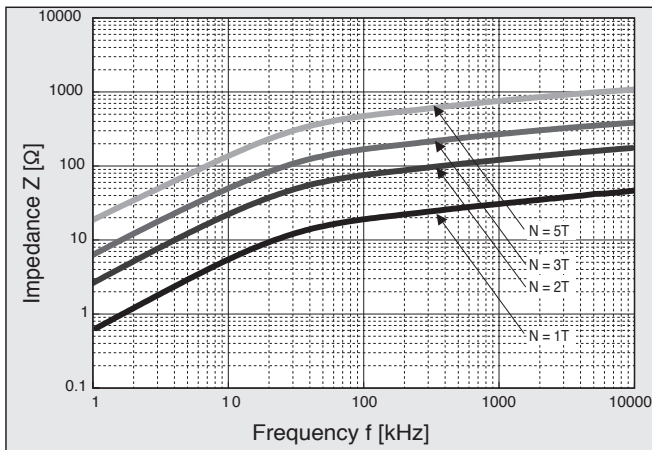

◆FREQUENCY - IMPEDANCE CHARACTERISTICS (4)

●LRF462725MKX

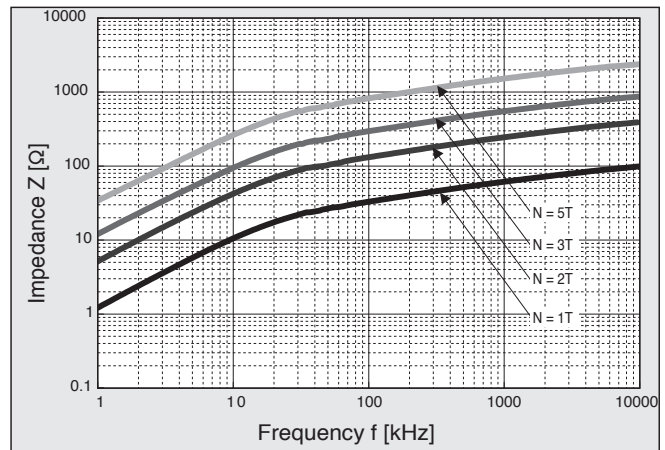

◆FREQUENCY - IMPEDANCE CHARACTERISTICS (5)

●LRF603525MKX

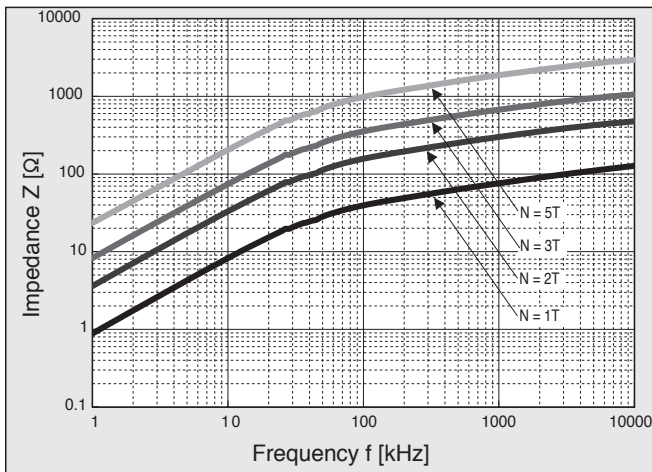

◆FREQUENCY - IMPEDANCE CHARACTERISTICS (6)

●LRF624520MKX

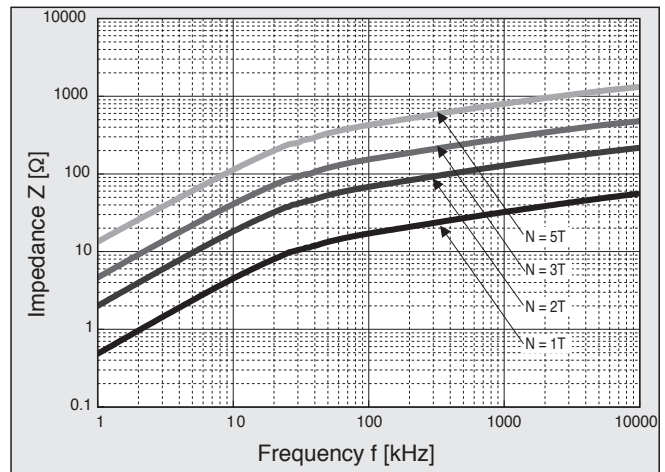

**FL** Series

◆ **MAJOR USES**

- Zero-phase reactor
- Filter line
- AC/DC power line noise control

◆ **FEATURES**

- Holes have been created to be used to attach the chassis to the housing case.
- High impedance in spite of a small number of turns
- Excellent temperature characteristics
- Conforming to insulating type B and incombustibility UL94-0

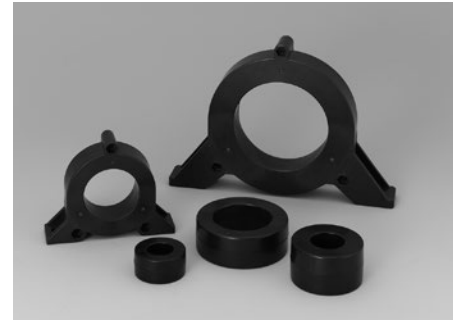

◆ **CORE STANDARD SPECIFICATIONS**

Core Part No.	Cross Sectional Area [cm <sup>2</sup> ]	Magnetic Path Length [cm]	AL [μH/at 0A]	
			10kHz	100kHz
LRF604520MBX	1.2typ.	16.4typ.	77.0typ.	13.0typ.
LRF1108020MBX	2.2typ.	30.0typ.	85.0typ.	15.0typ.

Core Part No.	Outside Dimensions [mm]								
	D	φID	H	W	P1	P2	P3	P4	P5
LRF604520MBX	95max.	39.5min.	78max.	26max.	80±0.5	7±0.5	50±0.5	72±0.5	12.5±0.3
LRF1108020MBX	181max.	74min.	131max.	26max.	150±0.5	20±0.5	100±0.5	124±0.5	12.5±0.3

Core Part No.	Applicable screws	
	h1	h2
LRF604520MBX	M4	M5
LRF1108020MBX	M5	M6

◆ **DIMENSIONS OF CORE**

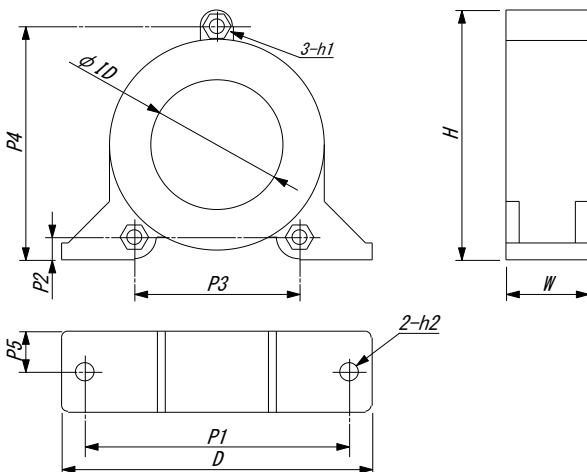

◆ **FREQUENCY - IMPEDANCE CHARACTERISTICS**  
(number of turns 1T)

