



## Three Phase Bridge + Thyristor

$V_{RRM} / V_{DRM}$  800 to 1800V  
 $I_{FAV} / I_{TAV}$  100A

### Features

- Blocking voltage:800 to 1800V
- Three Phase Bridge and a Thyristor
- Isolated Module package

### Applications

- Inverter for AC or DC motor control
- Current stabilized power supply
- Switching power supply
- UL recognized applied for file no. E360040

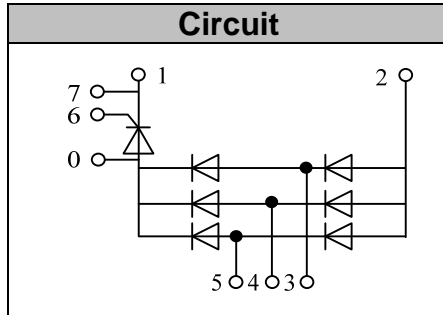

### Module Type

TYPE	$V_{RRM} / V_{DRM}$	$V_{RSM}$
MT100DT08L1	800V	900V
MT100DT12L1	1200V	1300V
MT100DT16L1	1600V	1700V
MT100DT18L1	1800V	1900V

### ◆ Diode

#### Maximum Ratings

Symbol	Item	Conditions	Values	Units
$I_D$	Output Current(D.C.)	$T_c=100^{\circ}\text{C}$ Three phase full wave	100	A
$I_{FSM}$	Surge forward current	$t=10\text{mS}$ $T_{vj}=45^{\circ}\text{C}$	1200	A
$i^2t$	Circuit Fusing Consideration		7200	$\text{A}^2\text{s}$
$V_{isol}$	Isolation Breakdown Voltage(R.M.S)	a.c.50HZ;r.m.s.;1min	3000	V
$T_{vj}$	Operating Junction Temperature		-40 to +150	$^{\circ}\text{C}$
$T_{stg}$	Storage Temperature		-40 to +125	$^{\circ}\text{C}$
$M_t$	Mounting Torque	To terminals(M5)	$3\pm 15\%$	Nm
$M_s$		To heatsink(M5)	$3\pm 15\%$	Nm
Weight		Module (Approximately)	210	g

#### Thermal Characteristics

Symbol	Item	Conditions	Values	Units
$R_{th(j-c)}$	Thermal Impedance, max.	Junction to Case(TOTAL)	0.18	$^{\circ}\text{C}/\text{W}$
$R_{th(c-s)}$	Thermal Impedance, max.	Case to Heatsink	0.10	$^{\circ}\text{C}/\text{W}$

#### Electrical Characteristics

Symbol	Item	Conditions	Values	Units
$V_{FM}$	Forward Voltage Drop, max.	$T=25^{\circ}\text{C}$ $I_F=100\text{A}$	1.35	V
$I_{RRM}$	Repetitive Peak Reverse Current, max.	$T_{vj}=25^{\circ}\text{C}$ $V_{RD}=V_{RRM}$ $T_{vj}=150^{\circ}\text{C}$ $V_{RD}=V_{RRM}$	$\leq 0.5$ $\leq 6$	$\text{mA}$ $\text{mA}$



## ◆Thyristor

### Maximum Ratings

Symbol	Item	Conditions	Values	Units
$I_{TAV}$	Average On-State Current	$T_c=92^{\circ}\text{C}$ , Single Phase half wave 180° conduction	100	A
$I_{TSM}$	Surge On-State Current	$T_{VJ}=45^{\circ}\text{C}$ $t=10\text{ms}$ (50Hz), sine $V_R=0$	1200	A
$i^2t$	Circuit Fusing Consideration		7200	$\text{A}^2\text{s}$
Visol	Isolation Breakdown Voltage(R.M.S)	a.c.50Hz;r.m.s.;1 min	3000	V
$T_{vj}$	Operating Junction Temperature		-40 to +125	$^{\circ}\text{C}$
$T_{stg}$	Storage Temperature		-40 to +125	$^{\circ}\text{C}$
$M_t$	Mounting Torque	To terminals(M5)	$3\pm 15\%$	Nm
$M_s$		To heatsink(M5)	$3\pm 15\%$	Nm
di/dt	Critical Rate of Rise of On-State Current	$T_{VJ}=T_{VJM}$ , $V_D=1/2V_{DRM}$ , $I_G=100\text{mA}$ $d_i/d_t=0.1\text{A}/\mu\text{s}$	150	$\text{A}/\mu\text{s}$
dv/dt	Critical Rate of Rise of Off-State Voltage, min.	$T_J=T_{VJM}$ , $V_D=2/3V_{DRM}$ , linear voltage rise	500	$\text{V}/\mu\text{s}$

### Electrical and Thermal Characteristics

Symbol	Item	Conditions	Values			Units
			Min.	Typ.	Max.	
$V_{TM}$	Peak On-State Voltage, max.	$T=25^{\circ}\text{C}$ $I_T=100\text{A}$			1.25	V
$I_{RRM}/I_{DRM}$	Repetitive Peak Reverse Current, max. / Repetitive Peak Off-State Current, max.	$T_{VJ}=T_{VJM}$ , $V_R=V_{RRM}$ , $V_D=V_{DRM}$			20	mA
$V_{GT}$	Gate Trigger Voltage, max.	$T_{VJ}=25^{\circ}\text{C}$ , $V_D=6\text{V}$		1	3	V
$I_{GT}$	Gate Trigger Current, typ /max.	$T_{VJ}=25^{\circ}\text{C}$ , $V_D=6\text{V}$		65	150	mA
$I_H$	Hoding Current, typ / max.	$T_{VJ}=25^{\circ}\text{C}$ , $V_D=6\text{V}$		120	220	mA
$I_L$	latching Current, typ / max.	$T_{VJ}=25^{\circ}\text{C}$ , $R=33\Omega$		180	400	mA
Rth(j-c)	Thermal Impedance, max.	Junction to Case			0.26	$^{\circ}\text{C}/\text{W}$
Rth(c-s)	Thermal Impedance, max.	Case to Heatsink			0.10	$^{\circ}\text{C}/\text{W}$



### Performance Curves

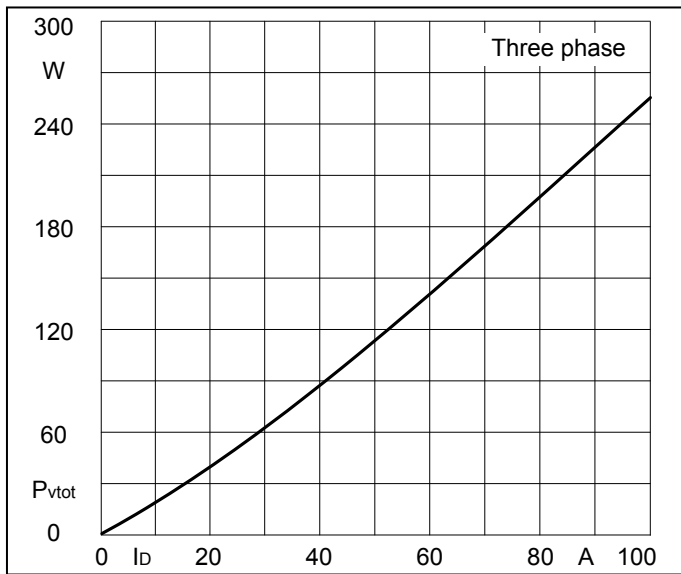

Fig1. Power dissipation

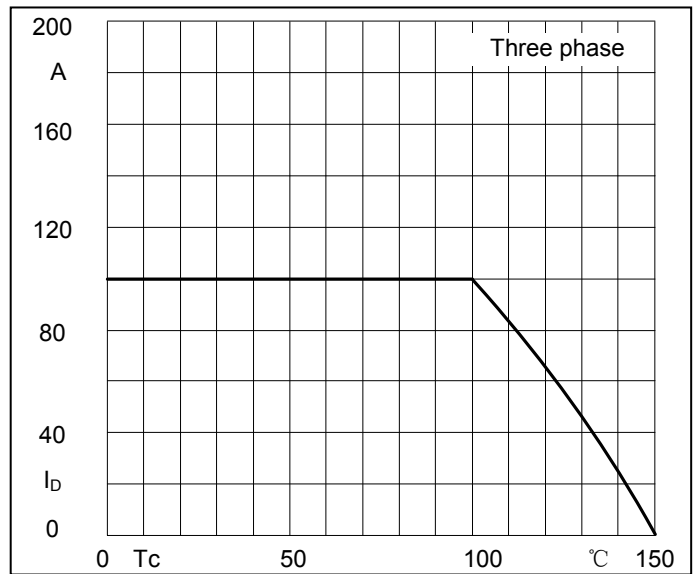

Fig2. Forward Current Derating Curve

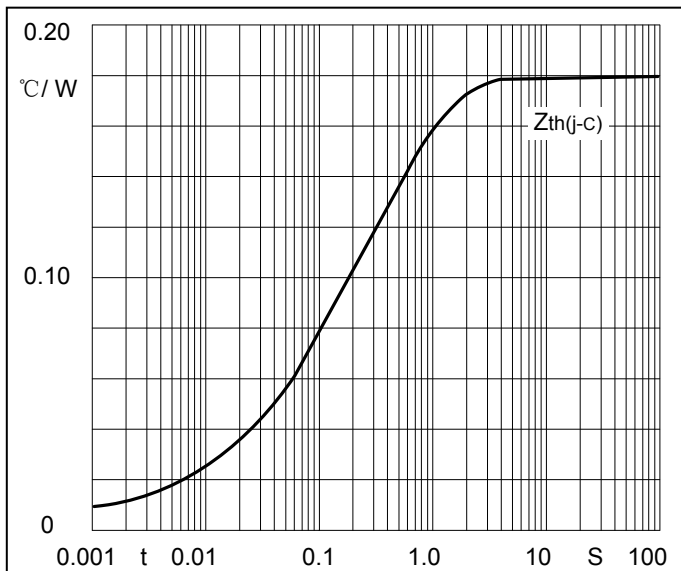

Fig3. Transient thermal impedance

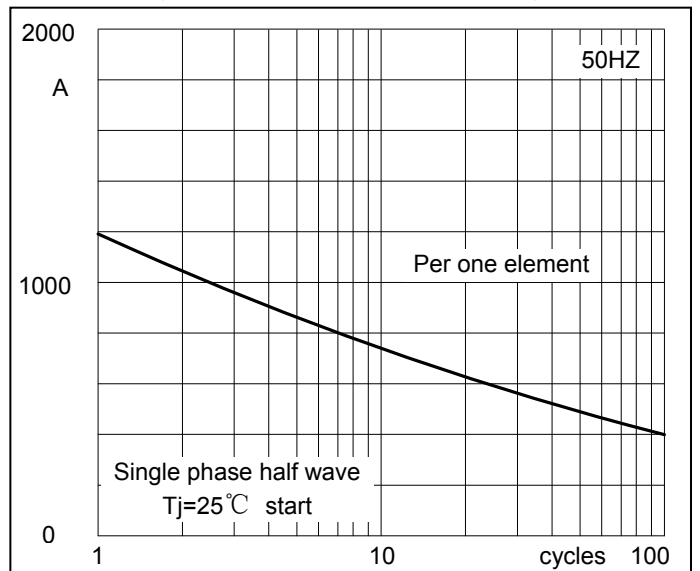

Fig4. Max Non-Repetitive Forward Surge Current

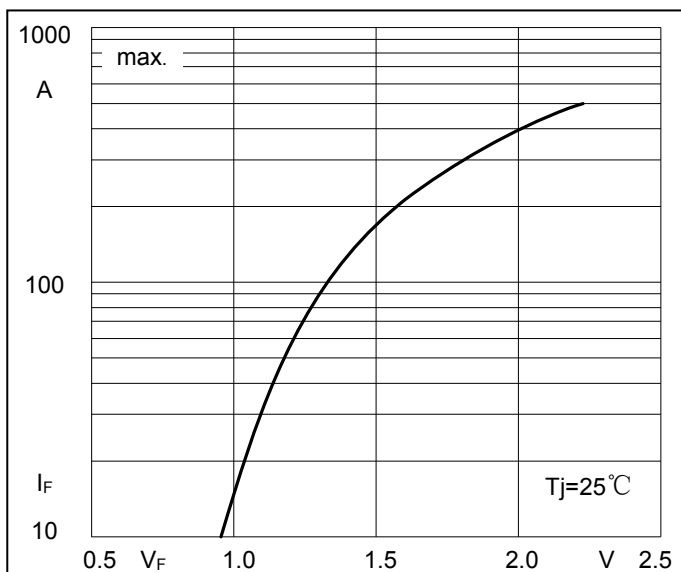

Fig5. Forward Characteristics

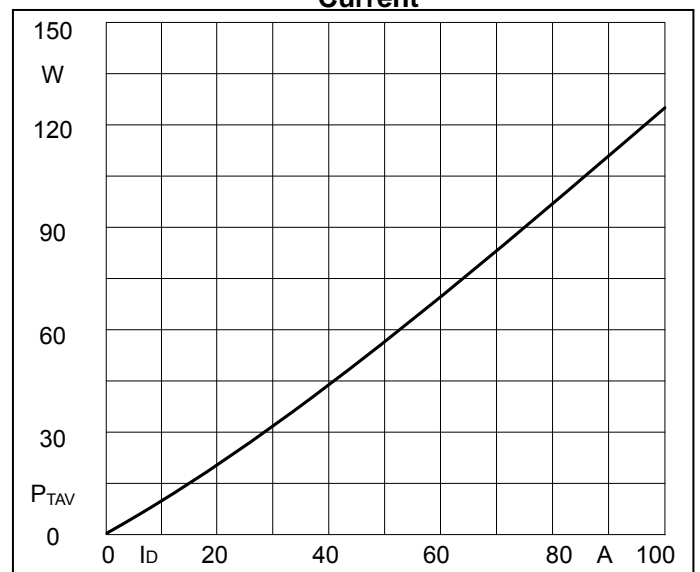

Fig6. SCR Power dissipation

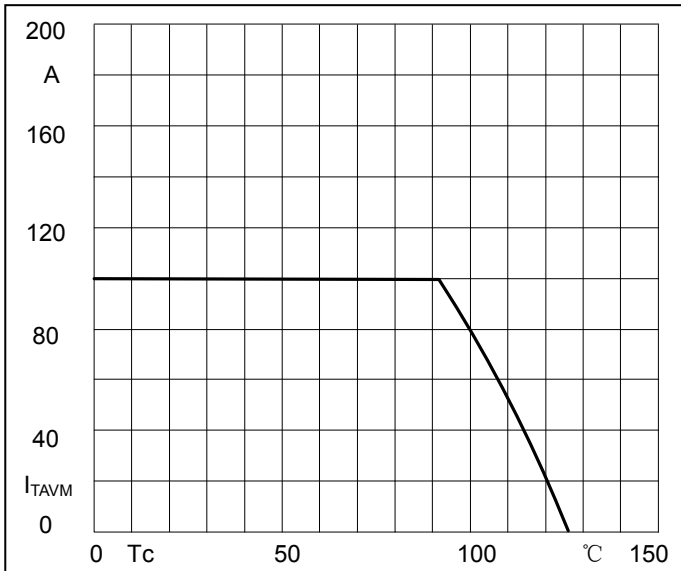

Fig7. SCR Forward Current Derating Curve

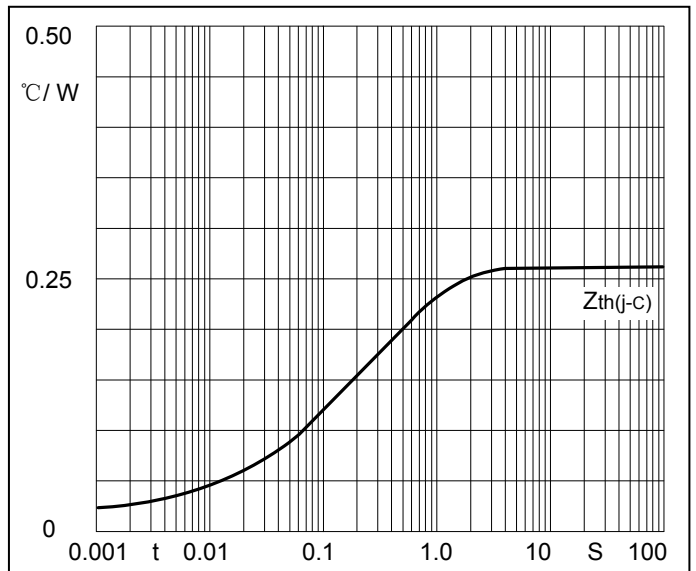

Fig8. SCR Transient thermal impedance

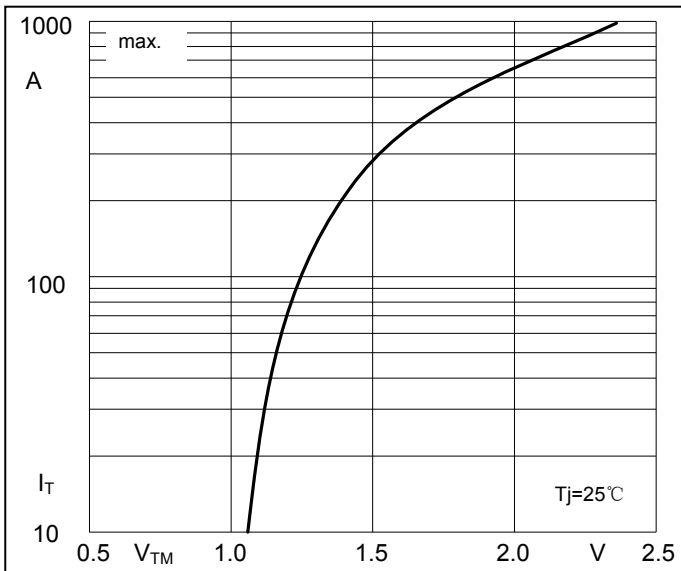

Fig9. SCR Forward Characteristics

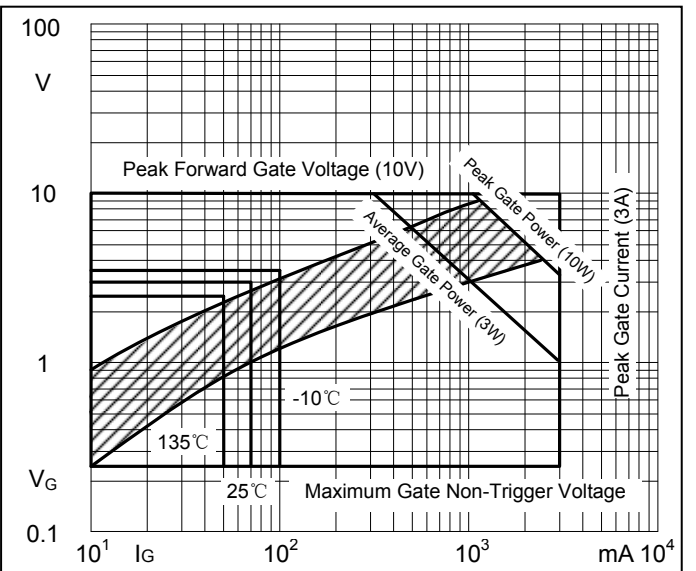

Fig10. Gate trigger Characteristics



**Package Outline Information**

