



Glass Passivated Rectifier Diode Modules

VRRM 800 to 1800V
IFAV 200 A

Applications

- Non-controllable rectifiers for AC/AC converters
- Line rectifiers for transistorized AC motor controllers
- Field supply for DC motors

Features

- Blocking voltage:800 to 1800V
- Heat transfer through aluminum oxide ceramic isolated metal baseplate
- Glass passivated chip
- UL recognized applied for file no. E360040

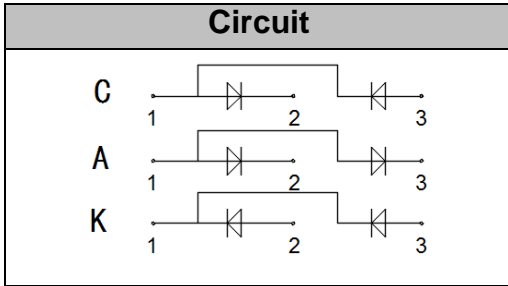

Module Type

TYPE			VRRM	VRSM
MD200C08D2	MD200A08D2	MD200K08D2	800V	900V
MD200C12D2	MD200A12D2	MD200K12D2	1200V	1300V
MD200C16D2	MD200A16D2	MD200K16D2	1600V	1700V
MD200C18D2	MD200A18D2	MD200K18D2	1800V	1900V

Maximum Ratings

Symbol	Conditions	Values	Units
IFAV	Single phase ,half wave 180° conduction Tc=95°C	200	A
IFSM	t=10ms Tvj =45°C	7500	A
	t=10ms Tvj =150°C	6900	A
i ² t	t=10ms Tvj =45°C	281250	A ² s
	t=10ms Tvj =150°C	238050	A ² s
Visol	a.c.50Hz;r.m.s.;1s / 1min	3600 / 3000	V
Tvj		-40 to 150	°C
Tstg		-40 to 125	°C
Mt	To terminals(M6)	5±15%	Nm
Ms	To heat sink(M6)	5±15%	Nm
Weight	Module (Approximately)	160	g

Thermal Characteristics

Symbol	Conditions	Values	Units
Rth(j-c)	Per diode	0.18	°C/W
Rth(c-s)	Per Module	0.05	°C/W



Electrical Characteristics

Symbol	Conditions	Values			Units
		Min.	Typ.	Max.	
V_{FM}	$T=25^{\circ}C$ $I_F=300A$	1	1.18	1.30	V
	$T=150^{\circ}C$ $I_F=300A$	1	1.16	1.22	V
I_{RD}	$T_{vj}=150^{\circ}C$ $V_{RD}=V_{RRM}$	—	—	9	mA
r_f	$T_{vj}=25^{\circ}C$		1.13		m Ω
	$T_{vj}=150^{\circ}C$		1.4		m Ω
V_{fO}	$T_{vj}=25^{\circ}C$		0.84		V
	$T_{vj}=150^{\circ}C$		0.74		V

Performance Curves

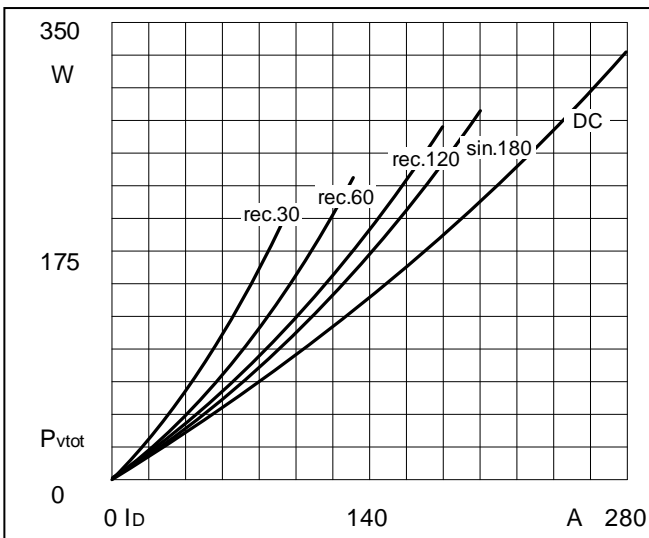

Fig1. Power dissipation vs Forward current

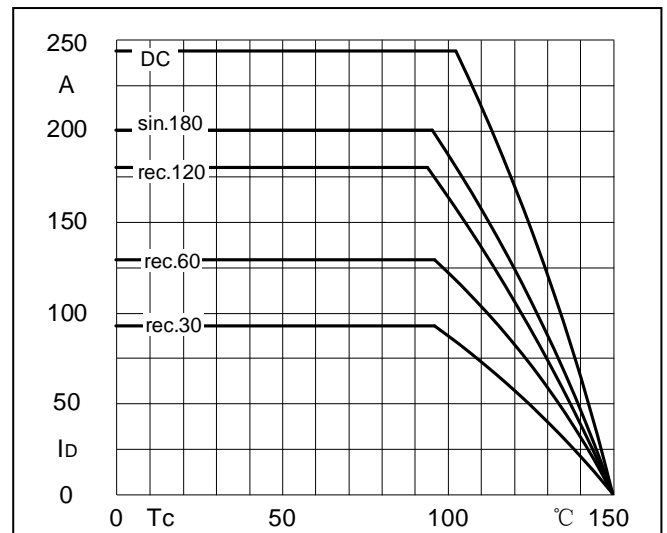

Fig2. Forward current derating curve vs Tc

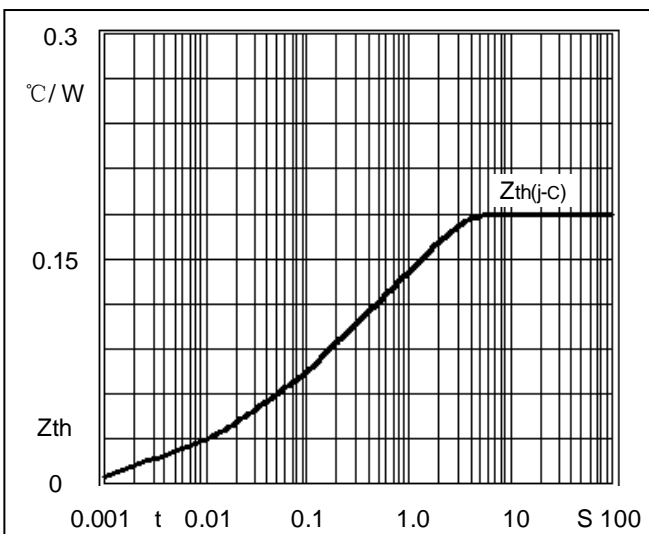

Fig3. Transient thermal impedance vs Time

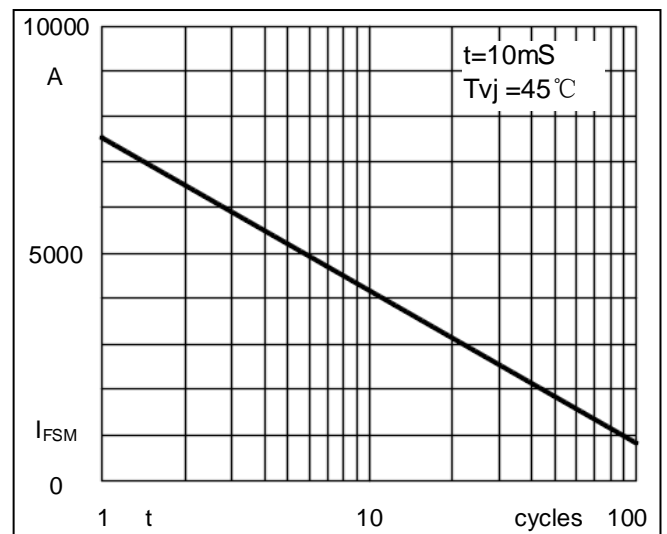

Fig4. Max non-repetitive forward surge current vs Times

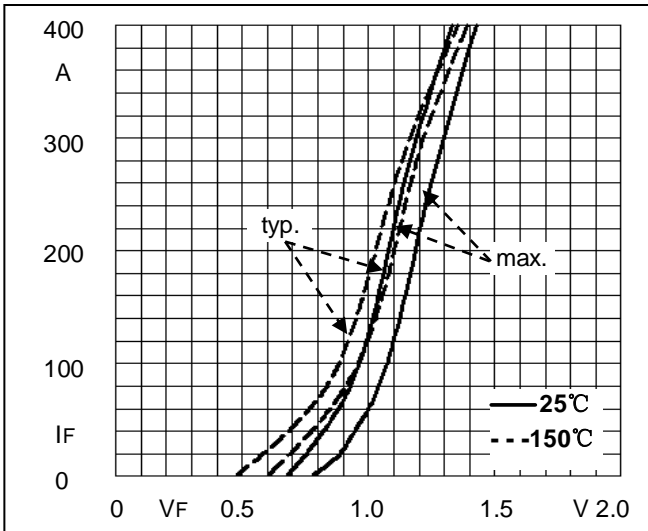
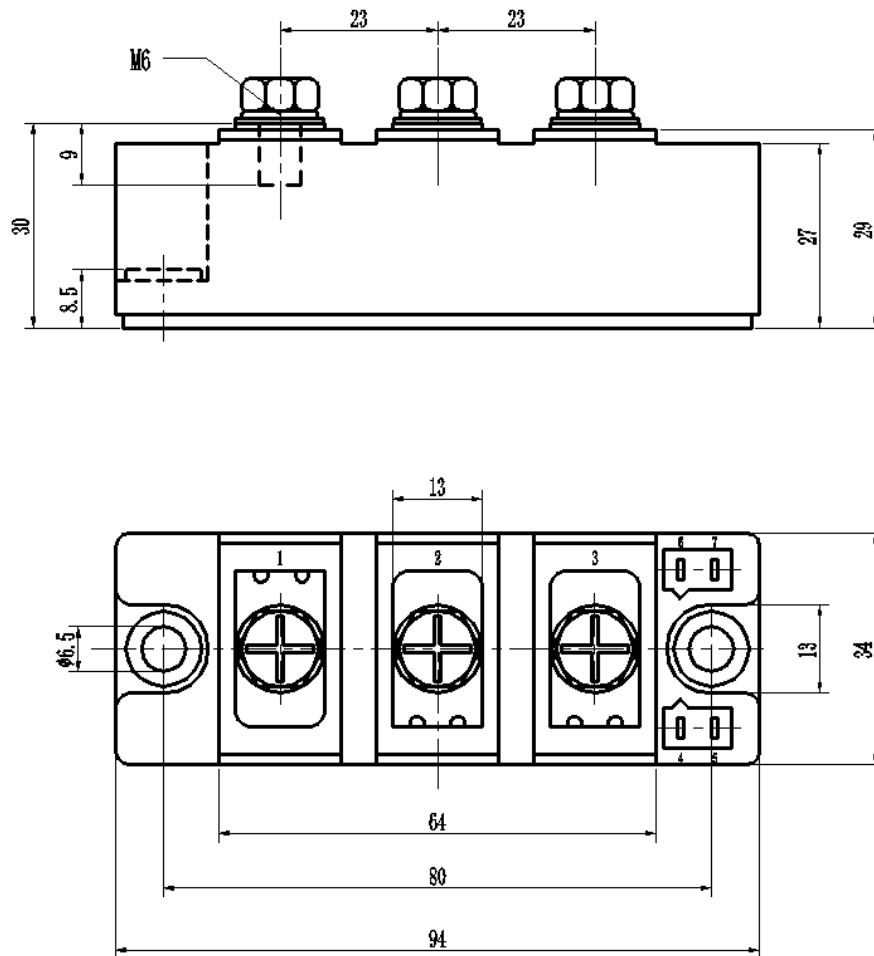

Fig5. Forward Characteristics

Package Outline Information

CASE: D2



Dimensions in mm