

JW RELAYS

1 Form A/1 Form C/2 Form A/2 Form C, 5 A/10 A, Power relays

Protective construction : Flux-resistant/Sealed

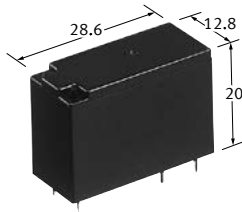

(Unit : mm)

FEATURES

- **Miniature/slim:**
12.8 mm(W) × 28.6 mm(L) × 20 mm(H)
- **Standard type (5 A) and high capacity type (10 A) are available**
- **PC board sockets are available**

TYPICAL APPLICATIONS

- **Home appliance**
- **Office machine**
- **Industrial equipment**

ORDERING INFORMATION (PART NO.)

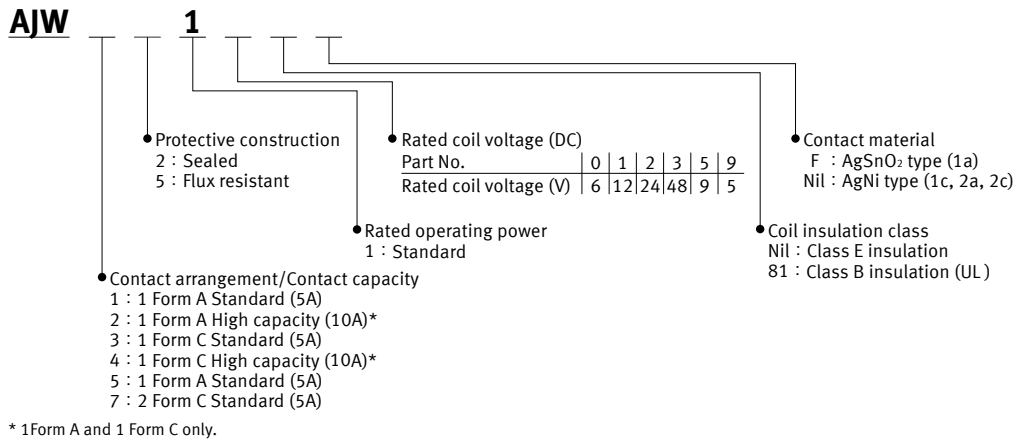

ORDERING INFORMATION (TYPE NO.)



Power relay (Over 2 A) JW RELAYS

TYPES

● Standard type (5 A)

Contact arrangement	Rated coil voltage	Sealed		Flux-resistant		Standard packing	
		Type No.	Part No.	Type No.	Part No.	Inner carton	Outer carton
1 Form A	5 V DC	JW1aSN-DC5V-F	AJW1219F	JW1aHN-DC5V-F	AJW1519F	100 pcs.	500 pcs.
	6 V DC	JW1aSN-DC6V-F	AJW1210F	JW1aHN-DC6V-F	AJW1510F		
	9 V DC	JW1aSN-DC9V-F	AJW1215F	JW1aHN-DC9V-F	AJW1515F		
	12 V DC	JW1aSN-DC12V-F	AJW1211F	JW1aHN-DC12V-F	AJW1511F		
	24 V DC	JW1aSN-DC24V-F	AJW1212F	JW1aHN-DC24V-F	AJW1512F		
	48 V DC	JW1aSN-DC48V-F	AJW1213F	JW1aHN-DC48V-F	AJW1513F		
1 Form C	5 V DC	JW1SN-DC5V	AJW3219	JW1HN-DC5V	AJW3519		
	6 V DC	JW1SN-DC6V	AJW3210	JW1HN-DC6V	AJW3510		
	9 V DC	JW1SN-DC9V	AJW3215	JW1HN-DC9V	AJW3515		
	12 V DC	JW1SN-DC12V	AJW3211	JW1HN-DC12V	AJW3511		
	24 V DC	JW1SN-DC24V	AJW3212	JW1HN-DC24V	AJW3512		
	48 V DC	JW1SN-DC48V	AJW3213	JW1HN-DC48V	AJW3513		
2 Form A	5 V DC	JW2aSN-DC5V	AJW5219	JW2aHN-DC5V	AJW5519		
	6 V DC	JW2aSN-DC6V	AJW5210	JW2aHN-DC6V	AJW5510		
	9 V DC	JW2aSN-DC9V	AJW5215	JW2aHN-DC9V	AJW5515		
	12 V DC	JW2aSN-DC12V	AJW5211	JW2aHN-DC12V	AJW5511		
	24 V DC	JW2aSN-DC24V	AJW5212	JW2aHN-DC24V	AJW5512		
	48 V DC	JW2aSN-DC48V	AJW5213	JW2aHN-DC48V	AJW5513		
2 Form C	5 V DC	JW2SN-DC5V	AJW7219	JW2HN-DC5V	AJW7519		
	6 V DC	JW2SN-DC6V	AJW7210	JW2HN-DC6V	AJW7510		
	9 V DC	JW2SN-DC9V	AJW7215	JW2HN-DC9V	AJW7515		
	12 V DC	JW2SN-DC12V	AJW7211	JW2HN-DC12V	AJW7511		
	24 V DC	JW2SN-DC24V	AJW7212	JW2HN-DC24V	AJW7512		
	48 V DC	JW2SN-DC48V	AJW7213	JW2HN-DC48V	AJW7513		

Note: Class B coil insulation type is available. Ex) AJW121181F

● High capacity type (10 A)

Contact arrangement	Rated coil voltage	Sealed		Flux-resistant		Standard packing	
		Type No.	Part No.	Type No.	Part No.	Inner carton	Outer carton
1 Form A	5 V DC	JW1aFSN-DC5V-F	AJW2219F	JW1aFHN-DC5V-F	AJW2519F	100 pcs.	500 pcs.
	6 V DC	JW1aFSN-DC6V-F	AJW2210F	JW1aFHN-DC6V-F	AJW2510F		
	9 V DC	JW1aFSN-DC9V-F	AJW2215F	JW1aFHN-DC9V-F	AJW2515F		
	12 V DC	JW1aFSN-DC12V-F	AJW2211F	JW1aFHN-DC12V-F	AJW2511F		
	24 V DC	JW1aFSN-DC24V-F	AJW2212F	JW1aFHN-DC24V-F	AJW2512F		
	48 V DC	JW1aFSN-DC48V-F	AJW2213F	JW1aFHN-DC48V-F	AJW2513F		
1 Form C	5 V DC	JW1FSN-DC5V	AJW4219	JW1FHN-DC5V	AJW4519		
	6 V DC	JW1FSN-DC6V	AJW4210	JW1FHN-DC6V	AJW4510		
	9 V DC	JW1FSN-DC9V	AJW4215	JW1FHN-DC9V	AJW4515		
	12 V DC	JW1FSN-DC12V	AJW4211	JW1FHN-DC12V	AJW4511		
	24 V DC	JW1FSN-DC24V	AJW4212	JW1FHN-DC24V	AJW4512		
	48 V DC	JW1FSN-DC48V	AJW4213	JW1FHN-DC48V	AJW4513		

Note: Class B coil insulation type is available. Ex) AJW121181F

For the sockets, please refer to the "JW RELAYS PC board sockets".

RATING

■ Coil data

- Operating characteristics such as 'Operate voltage' and 'Release voltage' are influenced by mounting conditions, ambient temperature, etc.

Therefore, please use the relay within $\pm 5\%$ of rated coil voltage.

- 'Initial' means the condition of products at the time of delivery.

Rated coil voltage	Operate voltage* ¹ (at 20°C)	Release voltage* ¹ (at 20°C)	Rated operating current ($\pm 10\%$, at 20°C)	Coil resistance ($\pm 10\%$, at 20°C)	Rated operating power	Max. allowable voltage
5 V DC	Max. 70% V of rated coil voltage (Initial)	Min. 10% V of rated coil voltage (Initial)	106 mA	47 Ω	530 mW	130% V of rated coil voltage (at 60°C: class E) 120% V of rated coil voltage (at 85°C: class B)* ²
6 V DC			88 mA	68 Ω		
9 V DC			58 mA	155 Ω		
12 V DC			44 mA	270 Ω		
24 V DC			22 mA	1,100 Ω		
48 V DC			11 mA	4,400 Ω		

*1. square, pulse drive

*2. The operate and release voltages rise approximately 0.4% for every 1°C given a standard ambient temperature of 20°C.

Therefore, when using relays where the ambient temperature is high, please take into consideration the rise in operate voltage and keep the coil applied voltage within the maximum allowable applied voltage.

■ Specifications

Item	Specifications		
	Standard type	High capacity type	
Contact data	Contact arrangement	1 Form A, 1 Form C, 2 Form A, 2 Form C	1 Form A, 1 Form C
	Contact resistance (initial)	Max. 100 m Ω (by voltage drop 6 V DC 1 A)	
	Contact material	1 Form A: AgSnO ₂ type, 1 Form C, 2 Form A, 2 Form C: AgNi type	
	Contact rating (resistive)	5 A 250 V AC, 5 A 30 V DC	10 A 250 V AC, 10 A 30 V DC
	Max. switching power (resistive)	1,250 VA, 150 W	2,500 VA, 300 W
	Max. switching voltage	250 V AC, 30 V DC	
	Max. switching current	5 A	10 A
	Min. switching load (reference value)* ¹	100 mA 5 V DC	
Insulation resistance (initial)	Min. 1,000 M Ω (at 500 V DC, Measured portion is the same as the case of dielectric strength.)		
Dielectric strength (initial)	Between open contacts	1,000 Vrms for 1 min (detection current: 10 mA)	
	Between contact sets	2 Form A, 2 Form C: 3,000 Vrms for 1 min (detection current: 10 mA)	—
	Between contact and coil	5,000 Vrms for 1 min (detection current: 10 mA)	
Surge withstand voltage (initial)* ²	Between contact and coil	10,000 V	
Time characteristics (initial)	Operate time	Max. 15 ms (at rated coil voltage, at 20°C, without bounce)	
	Release time	Max. 5 ms (at rated coil voltage, at 20°C, without bounce, without diode)	
Shock resistance	Functional	Min. 98 m/s ² (half-sine shock pulse: 11 ms, detection time: 10 μ s)	
	Destructive	Min. 980 m/s ² (half-sine shock pulse: 6 ms)	
Vibration resistance	Functional	10 to 55 Hz (at double amplitude of 1.6 mm, detection time: 10 μ s)	
	Destructive	10 to 55 Hz (at double amplitude of 2 mm)	
Expected life	Mechanical life	Min. 5 x 10 ⁶ (switching frequency: 180 times/min)	
Conditions	Conditions for usage, transport and storage* ³	Ambient temperature: -40 to +60°C (class E), -40 to +85°C (class B)* ⁴ Humidity: 5 to 85% RH (Avoid icing and condensation)	
Unit weight		Approx. 13 g	

*1. This value can change due to the switching frequency, environmental conditions, and desired reliability level, therefore it is recommended to check this with the actual load.

*2. Wave is standard shock voltage of $\pm 1.2 \times 50 \mu$ s according to JEC-212-1981

*3. For ambient temperature, please read "GUIDELINES FOR RELAY USAGE".

*4. The operate and release voltages rise approximately 0.4% for every 1°C given a standard ambient temperature of 20°C.

Therefore, when using relays where the ambient temperature is high, please take into consideration the rise in operate voltage and keep the coil applied voltage within the maximum allowable applied voltage.

Power relay (Over 2 A) JW RELAYS

Expected electrical life

Conditions: Resistive load, at 20°C, Flux-resistant: 20 times/min • Sealed: 6 times/min

Type	Switching capacity	Number of operations
1 Form A, 1 Form C, 2 Form A, 2 Form C (Standard)	5 A 250 V AC	Min. 10 ⁵
	5 A 30 V DC	Min. 10 ⁵
1 Form A, 1 Form C (High capacity)	10 A 250 V AC	Min. 10 ⁵
	10 A 30 V DC	Min. 10 ⁵

REFERENCE DATA

1 Form A Standard type

1. Max. switching capacity



2. Switching life curve



3. Operate and release time characteristics

Tested sample : JW1aSN-DC 12V-F, 10 pcs.
Ambient temperature : 20°C

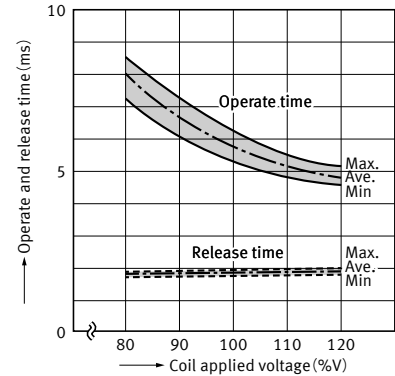

1 Form A High capacity type

1. Max. switching capacity

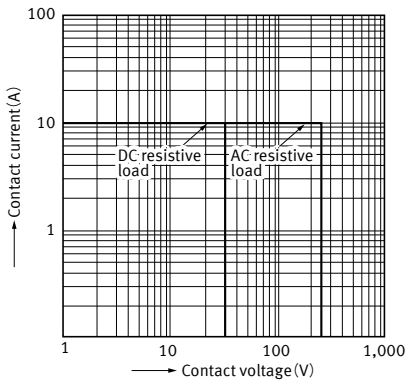

2. Switching life curve

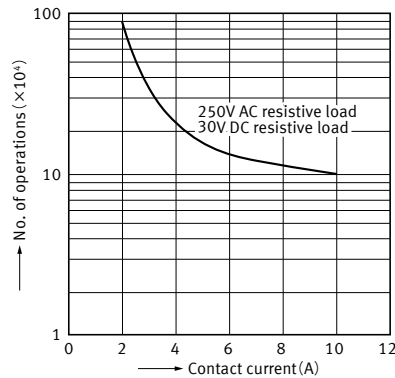

3-1. Coil temperature characteristics (Average)

Tested sample : JW1aFSN-DC 12V-F
Measured portion : Coil inside
Contact carrying current : 5A

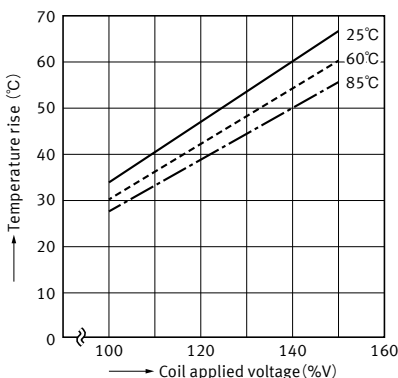

3-2. Coil temperature characteristics (Average)

Tested sample : JW1aFSN-DC 12V-F
Measured portion : Coil inside
Contact carrying current : 10A

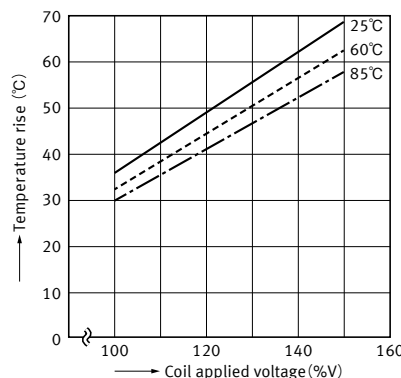

4. Operate and release time characteristics

Tested sample : JW1aFSN-DC 12V-F, 10 pcs.
Ambient temperature : 20°C

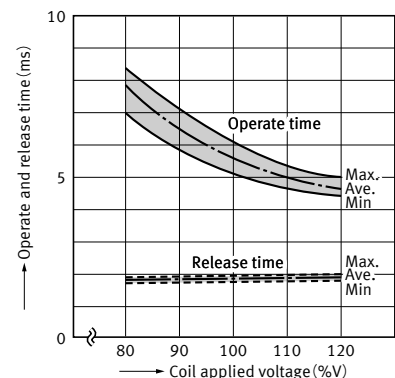

■ 1 Form C Standard type

1. Max. switching capacity



2. Operate and release time characteristics

Tested sample : JW1SN-DC 12V, 6 pcs.
Ambient temperature : 20°C

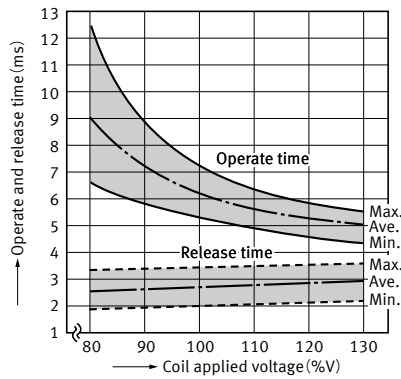

■ 1 Form C High capacity type

1. Max. switching capacity



■ 2 Form A Standard type

1. Max. switching capacity



2. Operate and release time characteristics

Tested sample : JW2aSN-DC 24V, 6 pcs.
Ambient temperature : 20°C

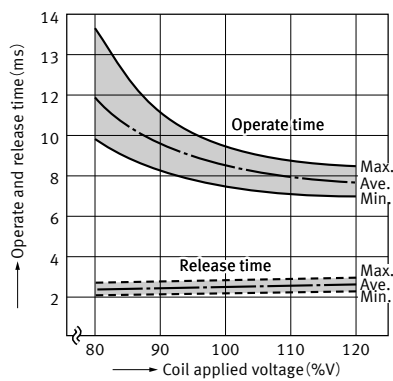

Power relay (Over 2 A) JW RELAYS

■ 2 Form C Standard type

1. Max. switching capacity



2. Operate and release time characteristics

Tested sample : JW2SN-DC 24V, 6 pcs.
Ambient temperature : 20°C

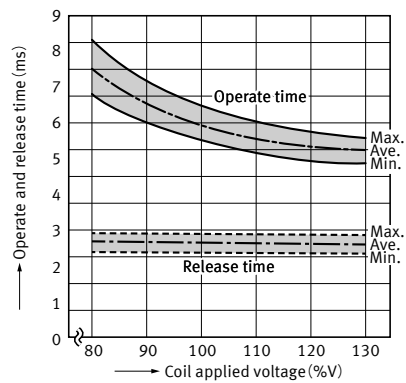

DIMENSIONS

CAD The CAD data of the products with a "CAD" mark can be downloaded from our Website.

Unit: mm

■ 1 Form A

CAD

External dimensions

Recommended PC board pattern (BOTTOM VIEW)

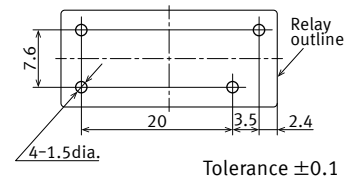

Schematic (BOTTOM VIEW)

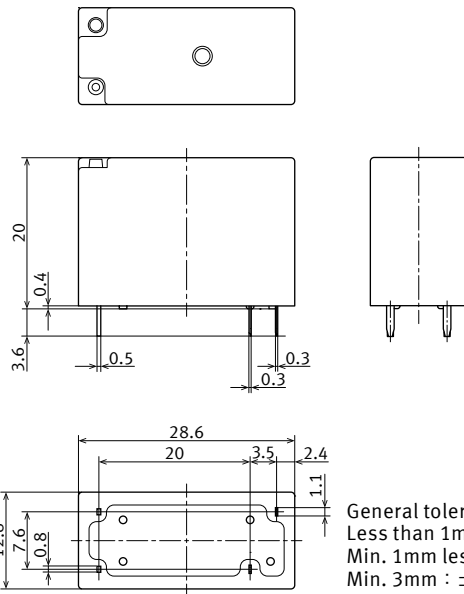

General tolerance
Less than 1mm : ± 0.1
Min. 1mm less than 3mm : ± 0.2
Min. 3mm : ± 0.3

■ 1 Form C

CAD



External dimensions



General tolerance
 Less than 1mm : ± 0.1
 Min. 1mm less than 3mm : ± 0.2
 Min. 3mm : ± 0.3

Recommended PC board pattern (BOTTOM VIEW)

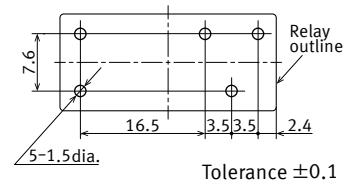

Schematic (BOTTOM VIEW)

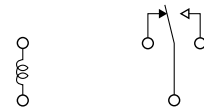

■ 2 Form A, 2 Form C

CAD



External dimensions



General tolerance
 Less than 1mm : ± 0.1
 Min. 1mm less than 3mm : ± 0.2
 Min. 3mm : ± 0.3

Recommended PC board pattern (BOTTOM VIEW)

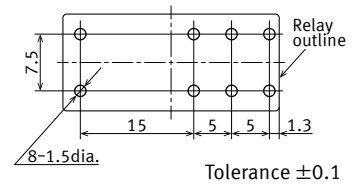

Schematic (BOTTOM VIEW)

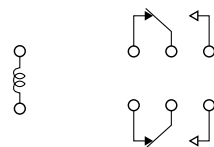

Note : JW 2 Form A is as shown in the diagram above except the N.C. terminals are not present.

SAFETY STANDARDS

■ UL (Recognized)

● Standard type

1 Form A

File No.	Contact rating
E43028	5 A 277 V AC
	5 A 30 V DC
	½ HP 250 V AC
	½ HP 125 V AC

2 Form A

File No.	Contact rating
E43028	5 A 277 V AC
	5 A 30 V DC
	½ HP 250 V AC
	½ HP 125 V AC

1 Form C

File No.	Contact rating
E43028	5 A 277 V AC
	5 A 30 V DC
	½ HP 250 V AC
	½ HP 125 V AC

2 Form C

File No.	Contact rating
E43028	5 A 277 V AC
	5 A 30 V DC
	½ HP 250 V AC
	½ HP 125 V AC

● High capacity type

1 Form A

File No.	Contact rating
E43028	10 A 277 V AC
	10 A 30 V DC
	½ HP 250 V AC
	½ HP 125 V AC

1 Form C

File No.	Contact rating
E43028	10 A 277 V AC
	10 A 30 V DC
	½ HP 250 V AC
	½ HP 125 V AC

■ CSA (Certified)

● Standard type

1 Form A

File No.	Contact rating
LR26550	5 A 277 V AC
	5 A 30 V DC
	½ HP 250 V AC
	½ HP 125 V AC

2 Form A

File No.	Contact rating
LR26550	5 A 277 V AC
	5 A 30 V DC
	½ HP 250 V AC
	½ HP 125 V AC

1 Form C

File No.	Contact rating
LR26550	5 A 277 V AC
	5 A 30 V DC
	½ HP 250 V AC
	½ HP 125 V AC

2 Form C

File No.	Contact rating
LR26550	5 A 277 V AC
	5 A 30 V DC
	½ HP 250 V AC
	½ HP 125 V AC

● High capacity type

1 Form A

File No.	Contact rating
LR26550	10 A 277 V AC
	10 A 30 V DC
	½ HP 250 V AC
	½ HP 125 V AC

1 Form C

File No.	Contact rating
LR26550	10 A 277 V AC
	10 A 30 V DC
	½ HP 250 V AC
	½ HP 125 V AC

■ VDE (Certified)

● Standard type

1 Form A

File No.	Contact rating
40013854	5 A 250 V AC (cosφ = 1.0)
	3 A 250 V AC (cosφ = 0.4)

2 Form A

File No.	Contact rating
40013854	5 A 250 V AC (cosφ = 1.0)
	5 A 30 V DC (0 ms)
	3 A 250 V AC (cosφ = 0.4)

1 Form C

File No.	Contact rating
40013854	5 A 250 V AC (cosφ = 1.0)
	5 A 30 V DC (0 ms)
	3 A 250 V AC (cosφ = 0.4)

2 Form C

File No.	Contact rating
40013854	5 A 250 V AC (cosφ = 1.0)
	5 A 30 V DC (0 ms)
	3 A 250 V AC (cosφ = 0.4)

● High capacity type

1 Form A

File No.	Contact rating
40013854	10 A 250 V AC (cosφ = 1.0)
	7 A 250 V AC (cosφ = 0.4)

1 Form C

File No.	Contact rating
40013854	10 A 250 V AC (cosφ = 1.0)
	10 A 30 V DC (0 ms)
	7 A 250 V AC (cosφ = 0.4)

■ CQC (Certified)

2 Form C (AJW7211 only)

File No.	Contact rating
CQC10002041727	5 A 250 V AC

INSULATION CHARACTERISTICS (IEC61810-1)

Item	Characteristics
Clearance/Creepage distance (IEC61810-1)	Min.5.5/8.0 mm
Category of protection (IEC61810-1)	RT II, III
Tracking resistance (IEC60112)	PTI 175
Insulation material group	III a
Over voltage category	III
Rated voltage	250 V
Pollution degree	3
Type of insulation (Between contact and coil)	Reinforced insulation
Type of insulation (Between open contacts)	Micro disconnection

Note: EN/IEC VDE Certified.

GUIDELINES FOR USAGE

■ For cautions for use, please read "GUIDELINES FOR RELAY USAGE".
https://industrial.panasonic.com/ac/e/control/relay/cautions_use/index.jsp

Please refer to "the latest product specifications" when designing your product.
 •Requests to customers:
<https://industrial.panasonic.com/ac/e/salespolicies/>

JW RELAYS PC board sockets



SELECTOR CHART

Relay type	Socket	JW1 PC board socket	JW2 PC board socket
	1 Form A		●
1 Form C		●	-
2 Form A		-	●
2 Form C		-	●

TYPES

Product name	Part No.	Standard packing	
		Inner carton	Outer carton
JW1 PC board socket	AJW8015	10 pcs.	100 pcs.
JW2 PC board socket	AJW8025		

RATING

Item	Specifications	
Contact arrangement	1 pole	2 poles
Dielectric strength (initial)	Between charging portion: 1,500 Vrms for 1 min (detection current: 10 mA)	
Insulation resistance (initial)	Between charging portion: Min. 100 MΩ (at 500 V DC, Measured portion is the same as the case of dielectric strength.)	
Maximum carrying current	10 A	5 A
Conditions for usage, transport and storage	Ambient temperature: -50 to +50°C Humidity: 5 to 85% RH (Avoid icing and condensation)	

DIMENSIONS

CAD The CAD data of the products with a "CAD" mark can be downloaded from our Website.

Unit: mm

CAD

External dimensions

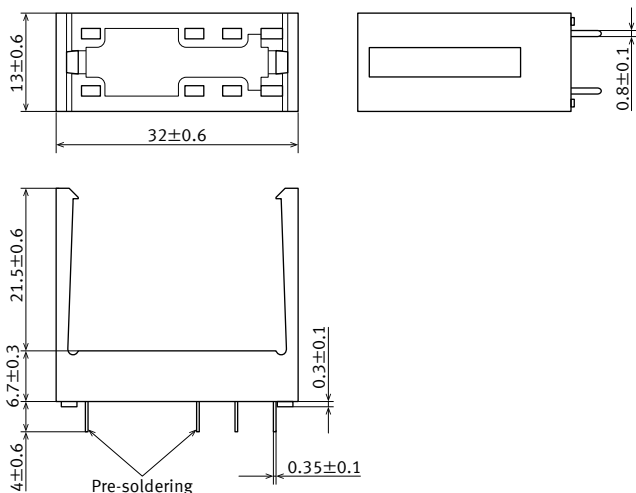

Recommended PC board pattern (Copper side view)

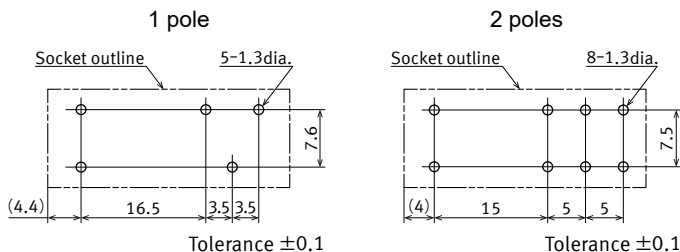

HANDLING

■ Mounting method of relay

1) Match the direction of relay and socket.

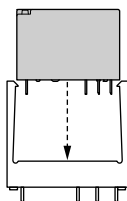

2) Both ends of the relay are to be secured firmly so that the socket both hooks on the top surface of the relay.

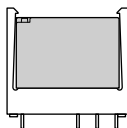

■ Removing method of relay

1) Remove the relay, applying force in the direction as shown in the figure.

2) In case there is not enough space to grasp relay with fingers, use screwdrivers in the way as shown in the figure.

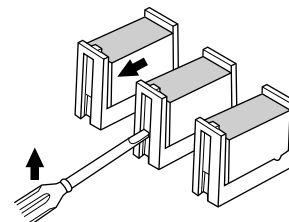

3) Exercise care when removing relays. If greater than necessary force is applied at the socket hooks, deformation may alter the dimensions so that the hook will no longer catch, and other damage may also occur.

Please refer to **"the latest product specifications"** when designing your product.

•Requests to customers:

<https://industrial.panasonic.com/ac/e/salespolicies/>

GUIDELINES FOR POWER, HIGH-CAPACITY DC CUT OFF AND SAFETY RELAYS USAGE

■ For cautions for use, please read “GUIDELINES FOR RELAY USAGE”.
https://industrial.panasonic.com/ac/e/control/relay/cautions_use/index.jsp

Precautions for Coil Input

■ Long term current carrying

A circuit that will be carrying a current continuously for long periods without relay switching operation. (circuits for emergency lamps, alarm devices and error inspection that, for example, revert only during malfunction and output warnings with form B contacts)
Continuous, long-term current to the coil will facilitate deterioration of coil insulation and characteristics due to heating of the coil itself. For circuits such as these, please use a magnetic-hold type latching relay. If you need to use a single stable relay, use a sealed type relay that is not easily affected by ambient conditions and make a failsafe circuit design that considers the possibility of contact failure or disconnection.

■ DC Coil operating power

Steady state DC current should be applied to the coil. The wave form should be rectangular. If it includes ripple, the ripple factor should be less than 5%.
However, please check with the actual circuit since the electrical characteristics may vary. The rated coil voltage should be applied to the coil and the set/reset pulse time of latching type relay differs for each relays, please refer to the relay's individual specifications.

■ Coil connection

When connecting coils of polarized relays, please check coil polarity (+,-) at the internal connection diagram (Schematic). If any wrong connection is made, it may cause unexpected malfunction, like abnormal heat, fire and so on, and circuit do not work. Avoid impressing voltages to the set coil and reset coil at the same time.

■ Maximum allowable voltage and temperature rise

Proper usage requires that the rated coil voltage be impressed on the coil. Note, however, that if a voltage greater than or equal to the maximum continuous voltage is impressed on the coil, the coil may burn or its layers short due to the temperature rise. Furthermore, do not exceed the usable ambient temperature range listed in the catalog.

■ Operate voltage change due to coil temperature rise

In DC relays, after continuous passage of current in the coil, if the current is turned OFF, then immediately turned ON again, due to the temperature rise in the coil, the pick-up voltage will become somewhat higher. Also, it will be the same as using it in a higher temperature atmosphere. The resistance/temperature relationship for copper wire is about 0.4% for 1°C, and with this ratio the coil resistance increases. That is, in order to operate of the relay, it is necessary that the voltage be higher than the pick-up voltage and the pick-up voltage rises in accordance with the increase in the resistance value. However, for some polarized relays, this rate of change is considerably smaller.

Ambient Environment

■ Usage, Transport, and Storage Conditions

During usage, storage, or transportation, avoid locations subjected to direct sunlight and maintain normal temperature, humidity and pressure conditions.

● Temperature/Humidity/Pressure

When transporting or storing relays while they are tube packaged, there are cases the temperature may differ from the allowable range. In this case be sure to check the individual specifications. Also allowable humidity level is influenced by temperature, please check charts shown below and use relays within mentioned conditions. (Allowable temperature values differ for each relays, please refer to the relay's individual specifications.)

1) Temperature:

The tolerance temperature range differs for each relays, please refer to the relay's individual specifications

2) Humidity: 5 to 85 % RH

3) Pressure: 86 to 106 kPa

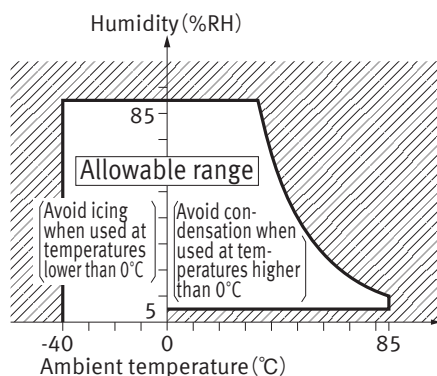

● Dew condensation

Condensation occurs when the ambient temperature drops suddenly from a high temperature and humidity, or the relay is suddenly transferred from a low ambient temperature to a high temperature and humidity. Condensation causes the failures like insulation deterioration, wire disconnection and rust etc. Panasonic Corporation does not guarantee the failures caused by condensation.

The heat conduction by the equipment may accelerate the cooling of device itself, and the condensation may occur.

Please conduct product evaluations in the worst condition of the actual usage. (Special attention should be paid when high temperature heating parts are close to the device. Also please consider the condensation may occur inside of the device.)

● Icing

Condensation or other moisture may freeze on relays when the temperature become lower than 0°C. This icing causes the sticking of movable portion, the operation delay and the contact conduction failure etc. Panasonic Corporation does not guarantee the failures caused by the icing.

The heat conduction by the equipment may accelerate the cooling of relay itself and the icing may occur. Please conduct product evaluations in the worst condition of the actual usage.

● Low temperature and low humidity

The plastic becomes brittle if the switch is exposed to a low temperature, low humidity environment for long periods of time.

● High temperature and high humidity

Storage for extended periods of time (including transportation periods) at high temperature or high humidity levels or in atmospheres with organic gases or sulfide gases may cause a sulfide film or oxide film to form on the surfaces of the contacts and/or it may interfere with the functions. Check out the atmosphere in which the units are to be stored and transported.

● Package

In terms of the packing format used, make every effort to keep the effects of moisture, organic gases and sulfide gases to the absolute minimum.

● Silicon

When a source of silicone substances (silicone rubber, silicone oil, silicone coating materials and silicone filling materials etc.) is used around the relay, the silicone gas (low molecular siloxane etc.) may be produced.

This silicone gas may penetrate into the inside of the relay. When the relay is kept and used in this condition, silicone compound may adhere to the relay contacts which may cause the contact failure.

Do not use any sources of silicone gas around the relay (Including plastic seal types).

● NOx Generation

When relay is used in an atmosphere high in humidity to switch a load which easily produces an arc, the NOx created by the arc and the water absorbed from outside the relay combine to produce nitric acid.

This corrodes the internal metal parts and adversely affects operation.

Avoid use at an ambient humidity of 85%RH or higher (at 20°C). If use at high humidity is unavoidable, please contact our sales representative.

Others

■ Cleaning

• Although the environmentally sealed type relay (plastic sealed type, etc.) can be cleaned, avoid immersing the relay into cold liquid (such as cleaning solvent) immediately after soldering. Doing so may deteriorate the sealing performance.

• Cleaning with the boiling method is recommended(The temperature of cleaning liquid should be 40°C or lower).

Avoid ultrasonic cleaning on relays. Use of ultrasonic cleaning may cause breaks in the coil or slight sticking of the contacts due to ultrasonic energy.

Please refer to **"the latest product specifications"** when designing your product.

•Requests to customers:

<https://industrial.panasonic.com/ac/e/salespolicies/>

Please contact

Panasonic Corporation

Electromechanical Control Business Division

■1006, Oaza Kadoma, Kadoma-shi, Osaka 571-8506, Japan
industrial.panasonic.com/ac/e/

Panasonic[®]

©Panasonic Corporation 2020