



# MIC261203

## 28V, 12A Hyper Light Load™ Synchronous DC/DC Buck Regulator

### SuperSwitcher IIG™

### General Description

The Micrel MIC261203 is a constant-frequency, synchronous DC/DC buck regulator featuring adaptive on-time control architecture. The MIC261203 operates over a supply range of 4.5V to 28V. It has an internal linear regulator which provides a regulated 5V to power the internal control circuitry. MIC261203 operates at a constant 600kHz switching frequency in continuous-conduction mode and can be used to provide up to 12A of output current. The output voltage is adjustable down to 0.8V.

Micrel's Hyper Light Load™ architecture provides the same high-efficiency and ultra-fast transient response as the Hyper Speed Control™ architecture under medium to heavy loads, but also maintains high efficiency under light load conditions by transitioning to variable frequency, discontinuous mode operation.

The MIC261203 offers a full suite of protection features to ensure protection of the IC during fault conditions. These include undervoltage lockout to ensure proper operation under power-sag conditions, thermal shutdown, internal soft start to reduce the inrush current, foldback current-limit and "hiccup" mode short-circuit protection. The MIC261203 includes a Power Good (PG) output to allow simple sequencing.

All support documentation can be found on Micrel's web site at: [www.micrel.com](http://www.micrel.com).

### Features

- Hyper Light Load™ efficiency – up to 80% at 10mA
- Hyper Speed Control™ architecture enables
  - High Delta V operation ( $V_{IN} = 28V$  and  $V_{OUT} = 0.8V$ )
  - Small output capacitance
- Input voltage range: 4.5V to 28V
- Output current up to 12A
- Up to 95% efficiency
- Adjustable output voltage from 0.8V to 5.5V
- $\pm 1\%$  FB accuracy
- Any Capacitor™ stable – zero-to-high ESR
- 600kHz switching frequency
- Power Good (PG) output
- Foldback current-limit and "hiccup" mode short-circuit protection
- Safe start-up into pre-biased loads
- 5mm x 6mm MLF® package
- $-40^{\circ}C$  to  $+125^{\circ}C$  junction temperature range

### Applications

- Distributed power systems
- Telecom/networking infrastructure
- Printers, scanners, graphic cards and video cards

### Typical Application

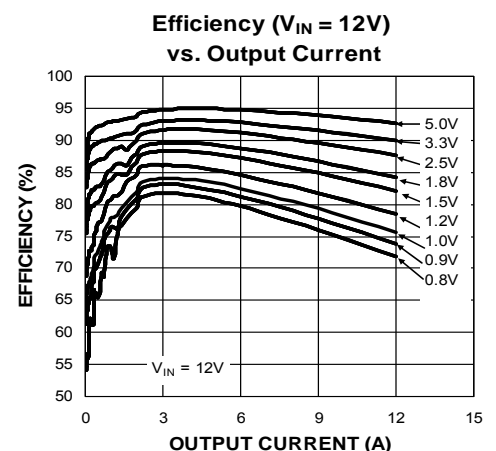
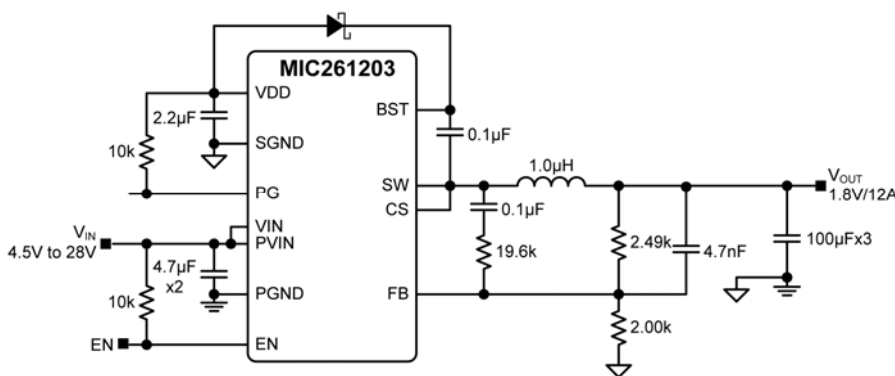

Hyper Speed Control, Hyper Light Load, SuperSwitcher II, and Any Capacitor are trademarks of Micrel, Inc.  
MLF and MicroLeadFrame are registered trademarks of Amkor Technology, Inc.

Micrel Inc. • 2180 Fortune Drive • San Jose, CA 95131 • USA • tel +1 (408) 944-0800 • fax + 1 (408) 474-1000 • <http://www.micrel.com>

## Ordering Information

Part Number	Voltage	Switching Frequency	Junction Temperature Range	Package	Lead Finish
MIC261203YJL	Adjustable	600kHz	-40°C to +125°C	28-Pin 5mm x 6mm MLF®	Pb-Free

## Pin Configuration

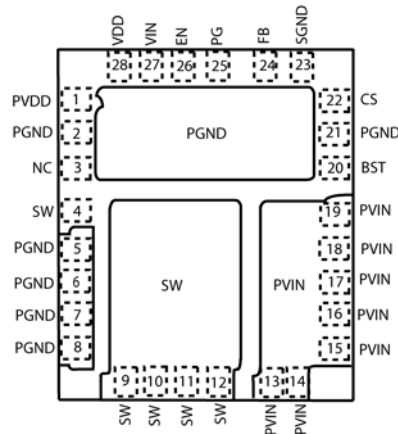

28-Pin 5mm x 6mm MLF® (YJL)

## Pin Description

Pin Number	Pin Name	Pin Function
1	PVDD	5V Internal Linear Regulator (Output): PVDD supply is the power MOSFET gate drive supply voltage and created by internal LDO from $V_{IN}$ . When $V_{IN} < +5.5V$ , PVDD should be tied to PVIN pins. A 2.2 $\mu F$ ceramic capacitor from the PVDD pin-to-PGND (pin 2) must be place next to the IC.
3	NC	No Connect.
4, 9, 10, 11, 12	SW	Switch Node (Output): Internal connection for the high-side MOSFET source and low-side MOSFET drain. Due to the high speed switching on this pin, the SW pin should be routed away from sensitive nodes.
2, 5, 6, 7, 8, 21	PGND	Power Ground. PGND is the ground path for the MIC26903 buck converter power stage. The PGND pins connect to the low-side N-Channel internal MOSFET gate drive supply ground, the sources of the MOSFETs, the negative terminals of input capacitors, and the negative terminals of output capacitors. The loop for the power ground should be as small as possible and separate from the Signal ground (SGND) loop.
13,14,15, 16,17,18,19	PVIN	High-Side N-internal MOSFET Drain Connection (Input): The $PV_{IN}$ operating voltage range is from 4.5V to 26V. Input capacitors between the PVIN pins and the power ground (PGND) are required and keep the connection short.
20	BST	Boost (Output): Bootstrapped voltage to the high-side N-channel MOSFET driver. A Schottky diode is connected between the PVDD pin and the BST pin. A boost capacitor of 0.1 $\mu F$ is connected between the BST pin and the SW pin. Adding a small resistor at the BST pin can slow down the turn-on time of high-side N-Channel MOSFETs.
22	CS	Current Sense (Input): The CS pin senses current by monitoring the voltage across the low-side MOSFET during the OFF-time. The current sensing is necessary for short circuit protection and zero current cross comparator. In order to sense the current accurately, connect the low-side MOSFET drain to SW using a Kelvin connection. The CS pin is also the high-side MOSFET's output driver return.

## Pin Description (Continued)

Pin Number	Pin Name	Pin Function
23	SGND	Signal ground. SGND must be connected directly to the ground planes. Do not route the SGND pin to the PGND Pad on the top layer, see PCB layout guidelines for details.
24	FB	Feedback (Input): Input to the transconductance amplifier of the control loop. The FB pin is regulated to 0.8V. A resistor divider connecting the feedback to the output is used to adjust the desired output voltage.
25	PG	Power Good (Output): Open Drain Output. The PG pin is externally tied with a resistor to VDD. A high output is asserted when $V_{OUT} > 92\%$ of nominal.
26	EN	Enable (input): A logic level control of the output. The EN pin is CMOS-compatible. Logic high = enable, logic low = shutdown. In the off state, supply current of the device is greatly reduced (typically 5 $\mu$ A). The EN pin should not be left open.
27	VIN	Power Supply Voltage (Input): Requires bypass capacitor to SGND.
28	VDD	5V Internal Linear Regulator (Output): VDD supply is the supply bus for the IC control circuit. VDD is created by internal LDO from $V_{IN}$ . When $V_{IN} < +5.5V$ , VDD should be tied to PVIN pins. A 1.0 $\mu$ F ceramic capacitor from the VDD pin to SGND pins must be placed next to the IC.

**Absolute Maximum Ratings<sup>(1,2)</sup>**

PV <sub>IN</sub> to PGND	-0.3V to +29V
V <sub>IN</sub> to PGND	-0.3V to PV <sub>IN</sub>
PV <sub>DD</sub> , V <sub>DD</sub> to PGND	-0.3V to +6V
V <sub>SW</sub> , V <sub>CS</sub> to PGND	-0.3V to (PV <sub>IN</sub> + 0.3V)
V <sub>BST</sub> to V <sub>SW</sub>	-0.3V to 6V
V <sub>BST</sub> to PGND	-0.3V to 35V
V <sub>FB</sub> , V <sub>PG</sub> to PGND	-0.3V to (V <sub>DD</sub> + 0.3V)
V <sub>EN</sub> to PGND	-0.3V to (V <sub>IN</sub> + 0.3V)
PGND to SGND	-0.3V to +0.3V
Junction Temperature	+150°C
Storage Temperature (T <sub>S</sub> )	-65°C to +150°C
Lead Temperature (soldering, 10sec)	260°C

**Operating Ratings<sup>(3)</sup>**

Supply Voltage (PV <sub>IN</sub> , V <sub>IN</sub> )	4.5V to 28V
PV <sub>DD</sub> , V <sub>DD</sub> Supply Voltage (PV <sub>DD</sub> , V <sub>DD</sub> )	4.5V to 5.5V
Enable Input (V <sub>EN</sub> )	0V to V <sub>IN</sub>
Junction Temperature (T <sub>J</sub> )	-40°C to +125°C
Maximum Power Dissipation	Note 4
Package Thermal Resistance <sup>(4)</sup>	
5mm x 6mm MLF <sup>®</sup> -24L (θ <sub>JA</sub> )	28°C/W

**Electrical Characteristics<sup>(5)</sup>**

PV<sub>IN</sub> = V<sub>IN</sub> = V<sub>EN</sub> = 12V, V<sub>BST</sub> - V<sub>SW</sub> = 5V; T<sub>A</sub> = 25°C, unless noted. **Bold** values indicate -40°C ≤ T<sub>J</sub> ≤ +125°C.

Parameter	Condition	Min.	Typ.	Max.	Units
<b>Power Supply Input</b>					
Input Voltage Range (V <sub>IN</sub> , PV <sub>IN</sub> )		<b>4.5</b>		<b>28</b>	V
Quiescent Supply Current	V <sub>FB</sub> = 1.5V (non-switching)		450	<b>750</b>	μA
Shutdown Supply Current	V <sub>EN</sub> = 0V		5	<b>10</b>	μA
<b>V<sub>DD</sub> Supply Voltage</b>					
V <sub>DD</sub> Output Voltage	V <sub>IN</sub> = 7V to 28V, I <sub>DD</sub> = 40mA	<b>4.8</b>	5	<b>5.4</b>	V
V <sub>DD</sub> UVLO Threshold	V <sub>DD</sub> Rising	<b>3.7</b>	4.2	<b>4.5</b>	V
V <sub>DD</sub> UVLO Hysteresis			400		mV
Dropout Voltage (V <sub>IN</sub> - V <sub>DD</sub> )	I <sub>DD</sub> = 25mA		380	<b>600</b>	mV
<b>DC/DC Controller</b>					
Output-Voltage Adjust Range (V <sub>OUT</sub> )		0.8		<b>5.5</b>	V
<b>Reference</b>					
	0°C ≤ T <sub>J</sub> ≤ 85°C (±1.0%)	<b>0.792</b>	0.8	<b>0.808</b>	V
	-40°C ≤ T <sub>J</sub> ≤ 125°C (±1.5%)	<b>0.788</b>	0.8	<b>0.812</b>	
Load Regulation	I <sub>OUT</sub> = 3A to 12A (Continuous Mode)		0.25		%
Line Regulation	V <sub>IN</sub> = 4.5V to 28V		0.25		%
FB Bias Current	V <sub>FB</sub> = 0.8V		50	<b>500</b>	nA
<b>Enable Control</b>					
EN Logic Level High		<b>1.8</b>			V
EN Logic Level Low				<b>0.6</b>	V
EN Bias Current	V <sub>EN</sub> = 12V		6	<b>30</b>	μA
<b>Oscillator</b>					
Switching Frequency <sup>(6)</sup>		<b>450</b>	600	<b>750</b>	kHz
Maximum Duty Cycle <sup>(7)</sup>	V <sub>FB</sub> = 0V		82		%
Minimum Duty Cycle	V <sub>FB</sub> = 1.0V		0		%
Minimum Off-Time			300		ns

## Electrical Characteristics<sup>(5)</sup> (Continued)

$PV_{IN} = V_{IN} = V_{EN} = 12V$ ,  $V_{BST} - V_{SW} = 5V$ ;  $T_A = 25^\circ C$ , unless noted. **Bold** values indicate  $-40^\circ C \leq T_J \leq +125^\circ C$ .

Parameter	Condition	Min.	Typ.	Max.	Units
<b>Soft-Start</b>					
Soft-Start time			5		ms
<b>Short-Circuit Protection</b>					
Current-Limit Threshold	$V_{FB} = 0.8V$ , $T_J = 25^\circ C$	18.75	26	33	A
Current-Limit Threshold	$V_{FB} = 0.8V$ , $T_J = 125^\circ C$	17.36	26	33	A
Short-Circuit Current	$V_{FB} = 0V$		6		A
<b>Internal FETs</b>					
			6		
Top-MOSFET $R_{DS(ON)}$	$I_{SW} = 3A$		13		m $\Omega$
Bottom-MOSFET $R_{DS(ON)}$	$I_{SW} = 3A$		5.3		m $\Omega$
SW Leakage Current	$V_{EN} = 0V$			<b>60</b>	$\mu A$
$V_{IN}$ Leakage Current	$V_{EN} = 0V$			<b>25</b>	$\mu A$
<b>Power Good</b>					
PG Threshold Voltage	Sweep $V_{FB}$ from Low to High	<b>85</b>	92	<b>95</b>	% $V_{OUT}$
PG Hysteresis	Sweep $V_{FB}$ from High to Low		5.5		% $V_{OUT}$
PG Delay Time	Sweep $V_{FB}$ from Low to High		100		$\mu s$
PG Low Voltage	Sweep $V_{FB} < 0.9 \times V_{NOM}$ , $I_{PG} = 1mA$		70	<b>200</b>	mV
<b>Thermal Protection</b>					
Over-Temperature Shutdown	$T_J$ Rising		160		$^\circ C$
Over-Temperature Shutdown Hysteresis			15		$^\circ C$

### Notes:

- Exceeding the absolute maximum rating may damage the device.
- Devices are ESD sensitive. Handling precautions recommended. Human body model, 1.5k $\Omega$  in series with 100pF.
- The device is not guaranteed to function outside operating range.
- $PD_{(MAX)} = (T_{J(MAX)} - T_A) / \theta_{JA}$ , where  $\theta_{JA}$  depends upon the printed circuit layout. A 5 square inch 4 layer, 0.62", FR-4 PCB with 2oz finish copper weight per layer is used for the  $\theta_{JA}$ .
- Specification for packaged product only.
- Measured in test mode.
- The maximum duty-cycle is limited by the fixed mandatory off-time  $t_{OFF}$  of typically 300ns.

# Typical Characteristics

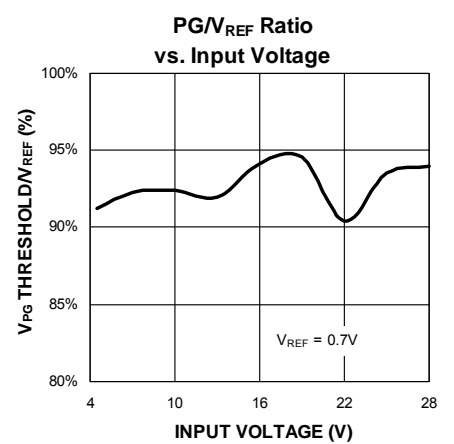
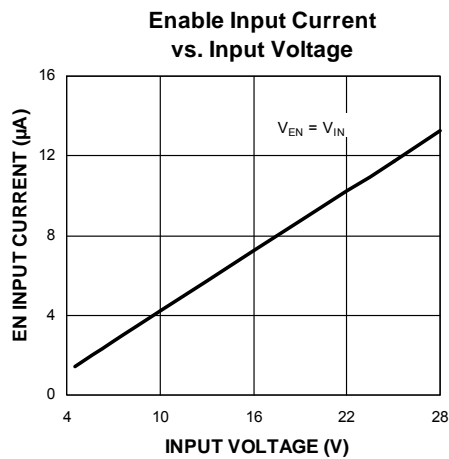
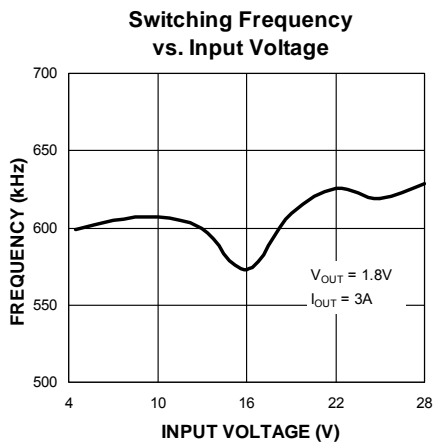
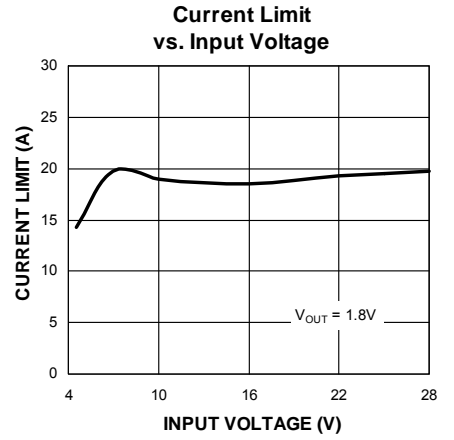
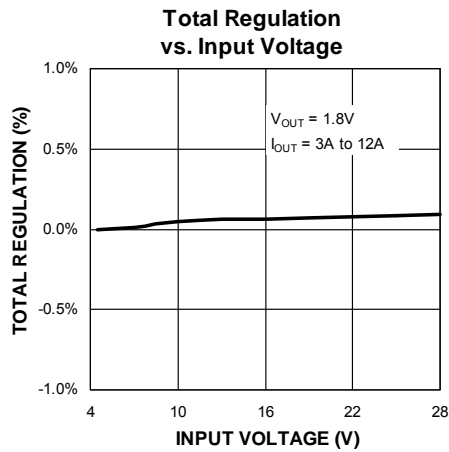
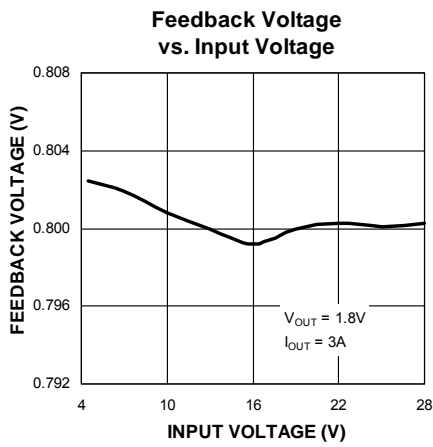
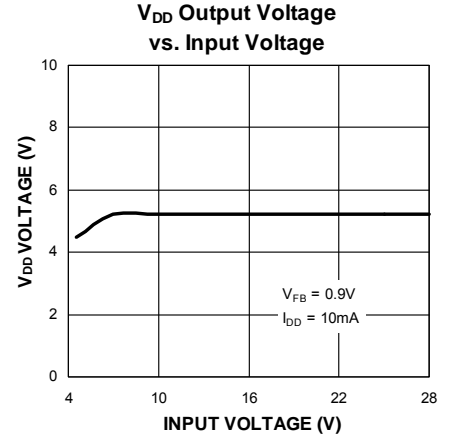
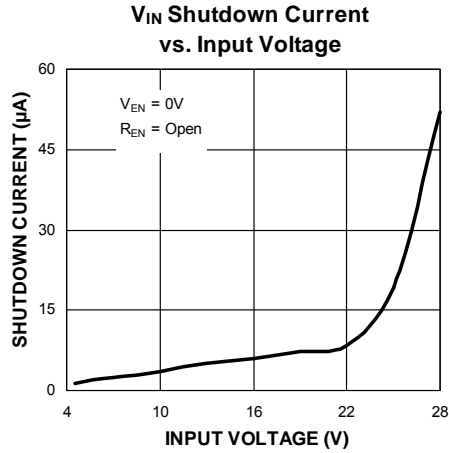
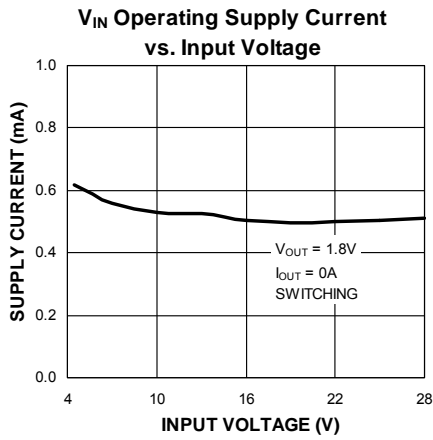

## Typical Characteristics (Continued)

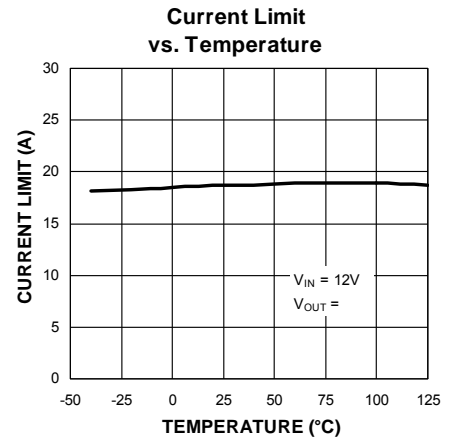
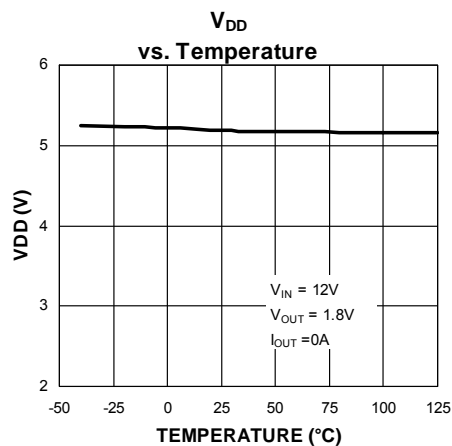
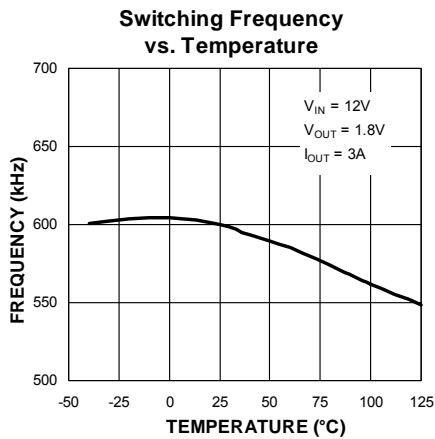
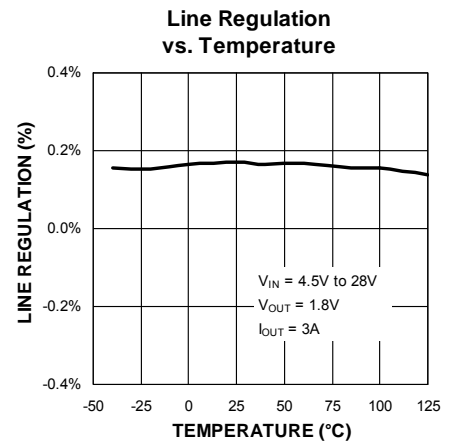
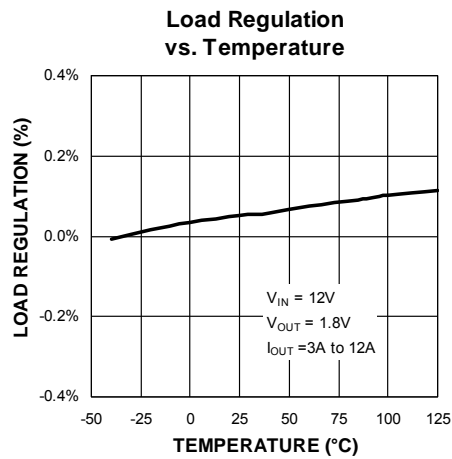
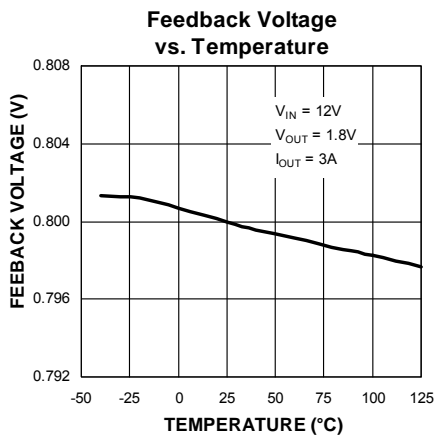
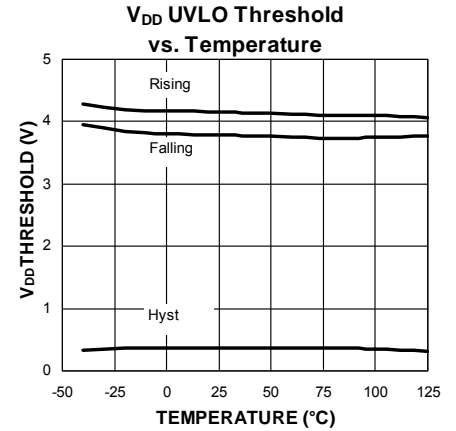
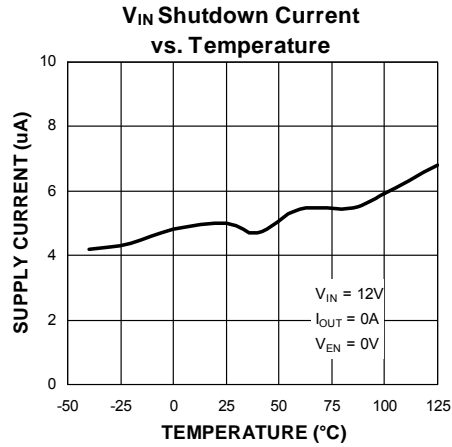
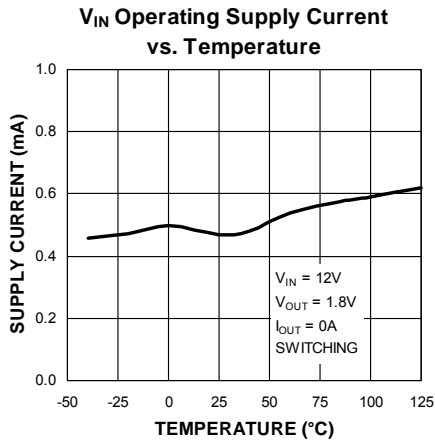

Typical Characteristics (Continued)

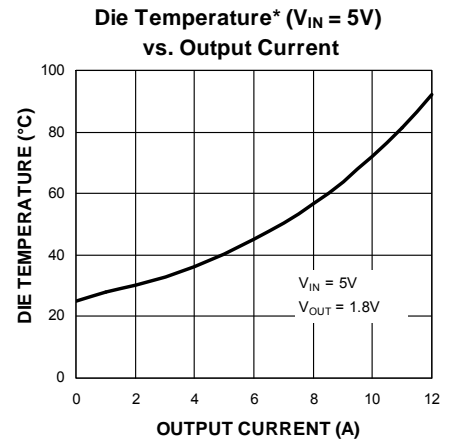
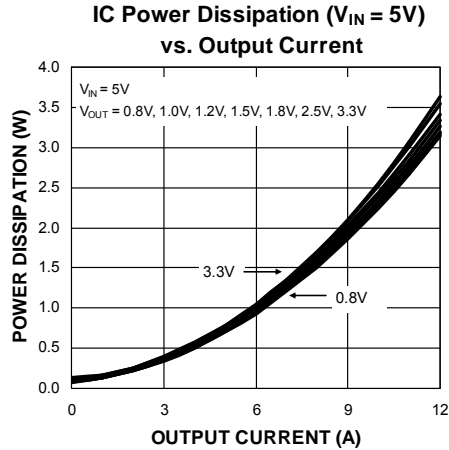
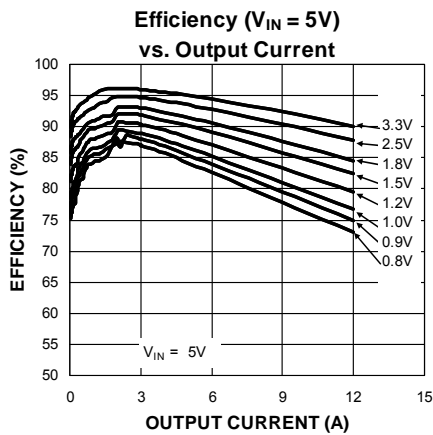
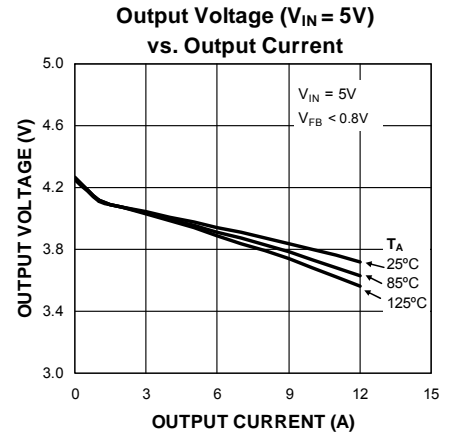
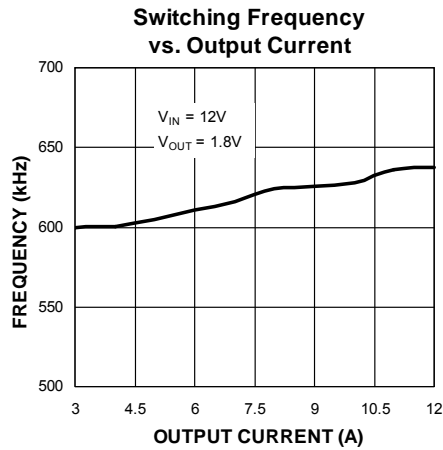
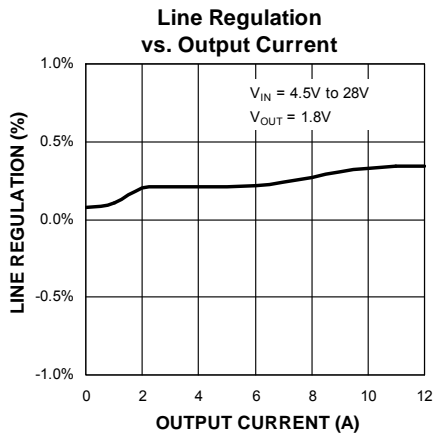
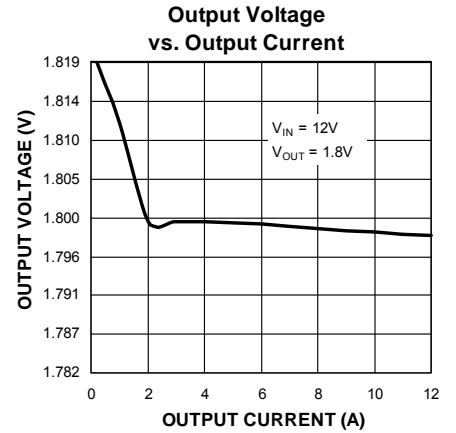
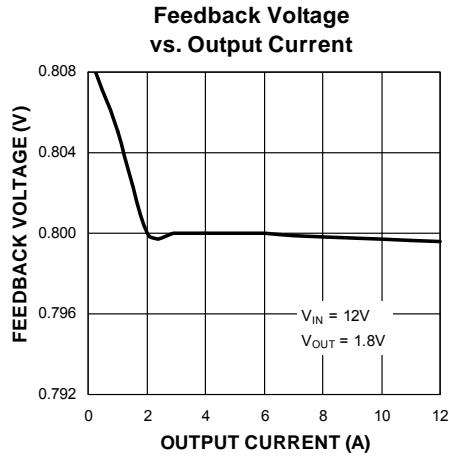
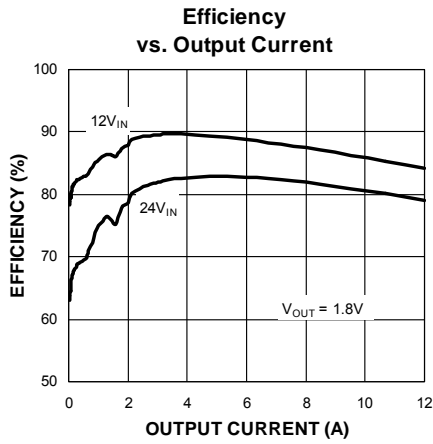



## Typical Characteristics (Continued)

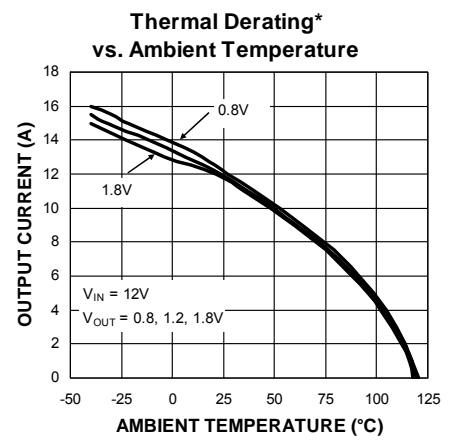
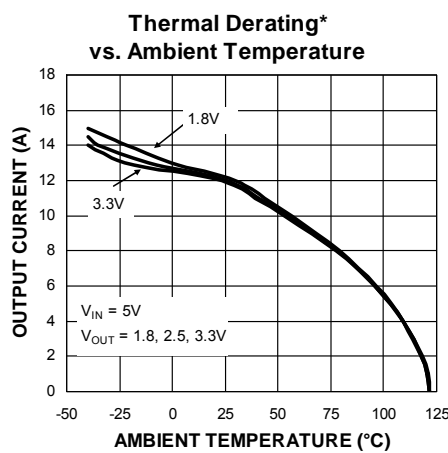
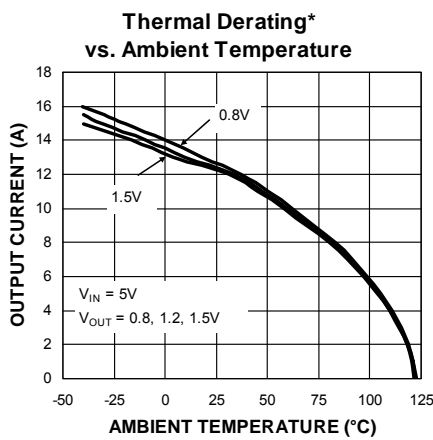
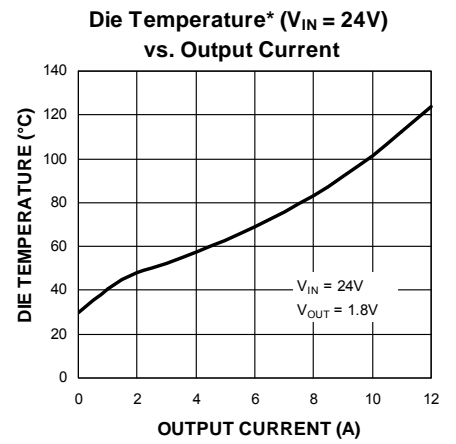
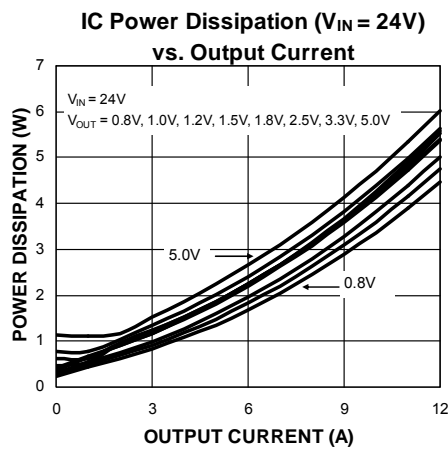
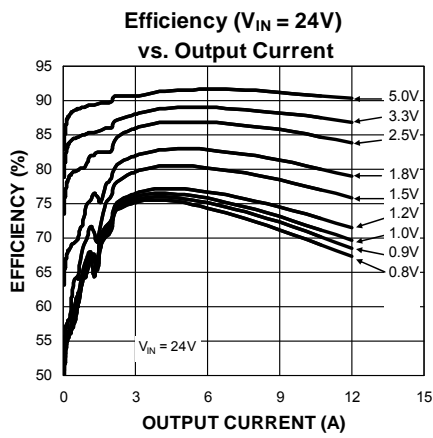
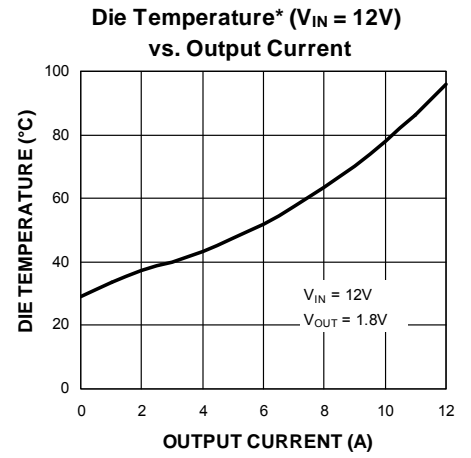
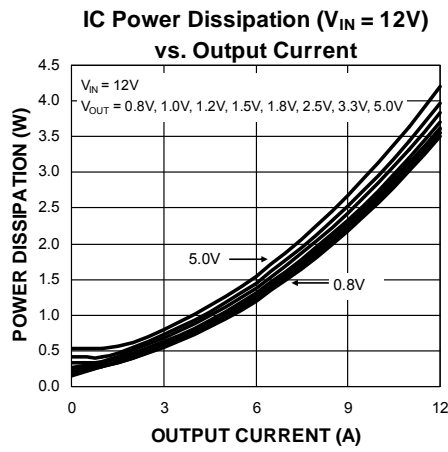
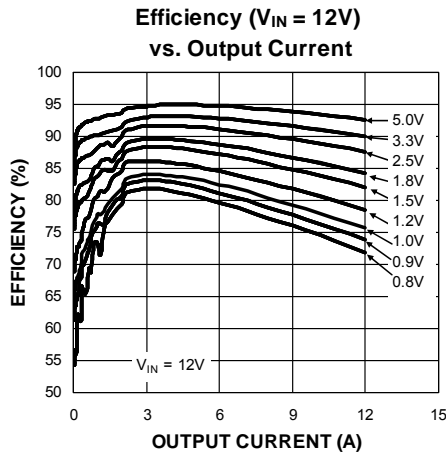

## Typical Characteristics (Continued)

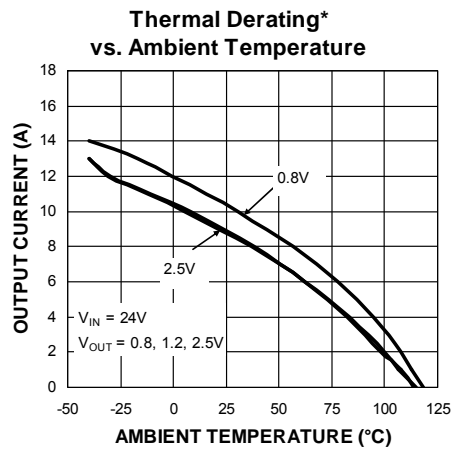
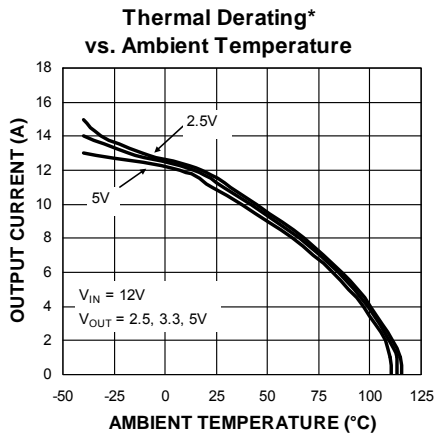

**Die Temperature\*** : The temperature measurement was taken at the hottest point on the MIC261203 case mounted on a 5 square inch 4 layer, 0.62", FR-4 PCB with 2oz finish copper weight per layer; see Thermal Measurement section. Actual results will depend upon the size of the PCB, ambient temperature and proximity to other heat emitting components.

## Functional Characteristics

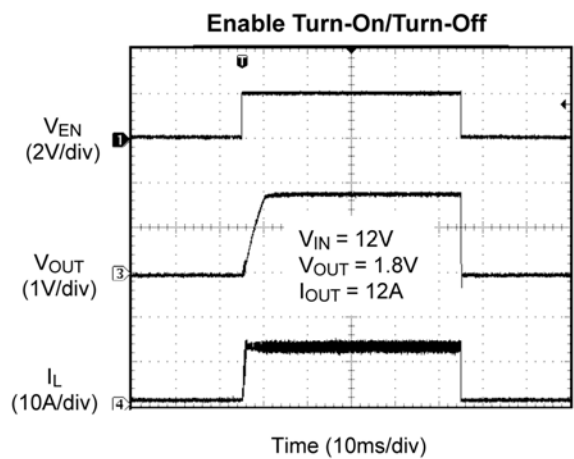
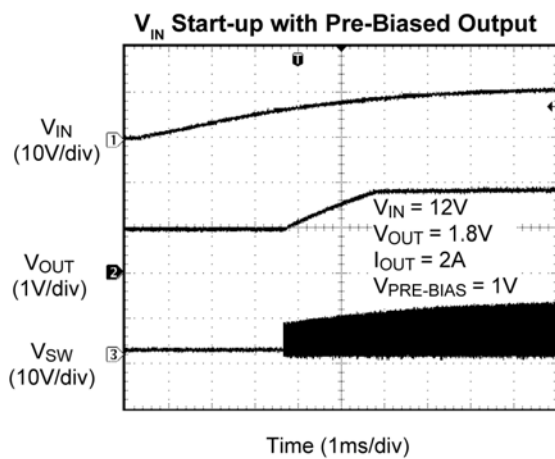
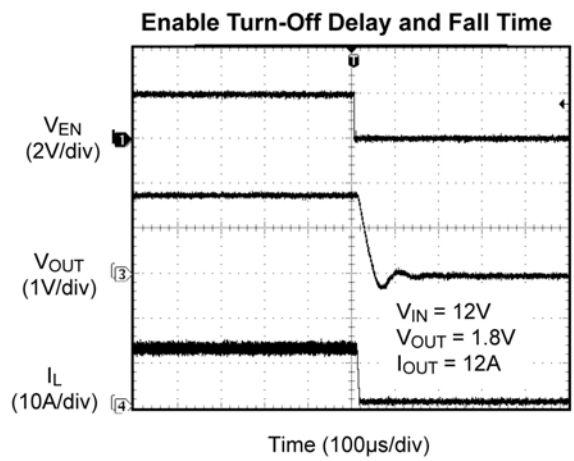
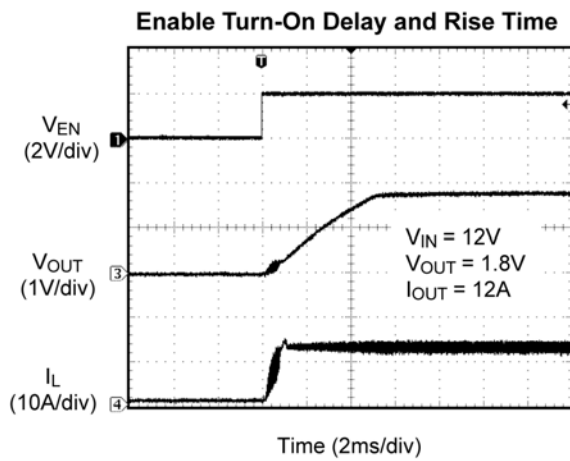
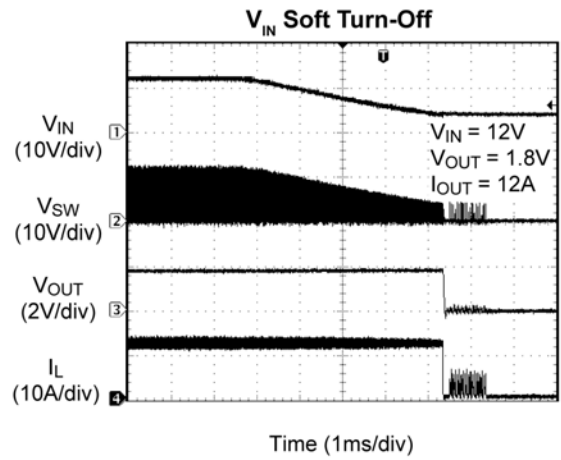
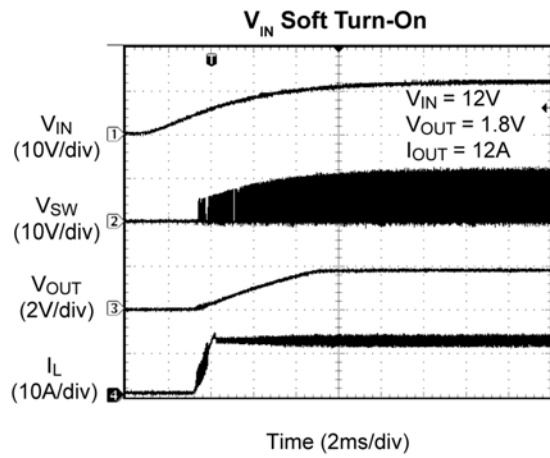

## Functional Characteristics (Continued)

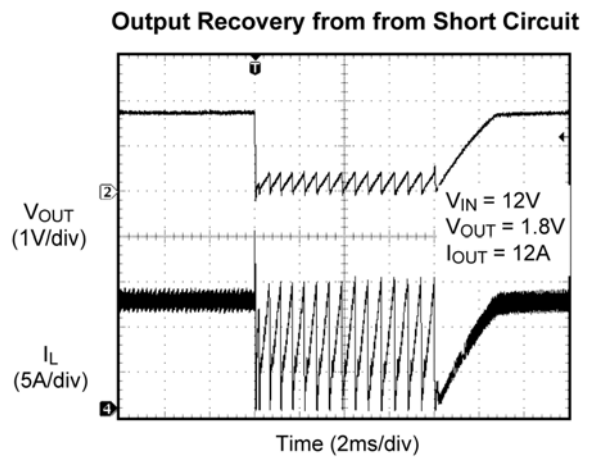
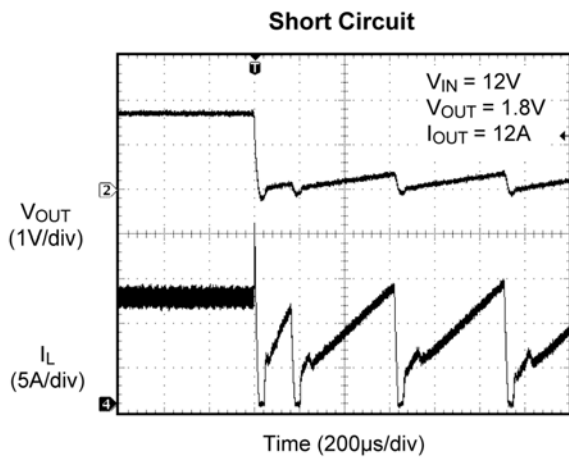
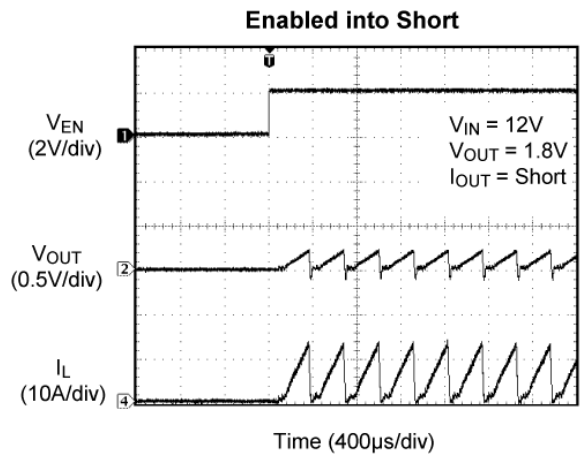
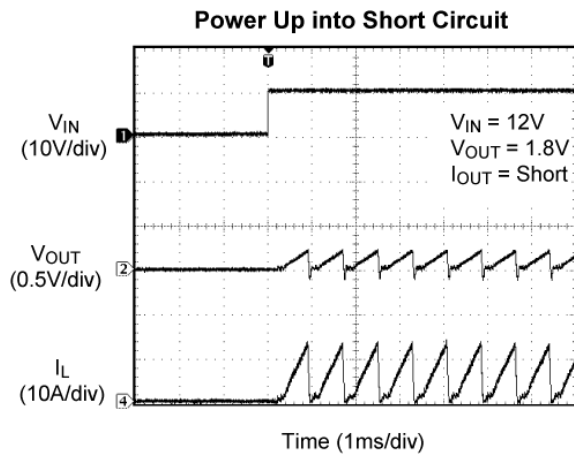
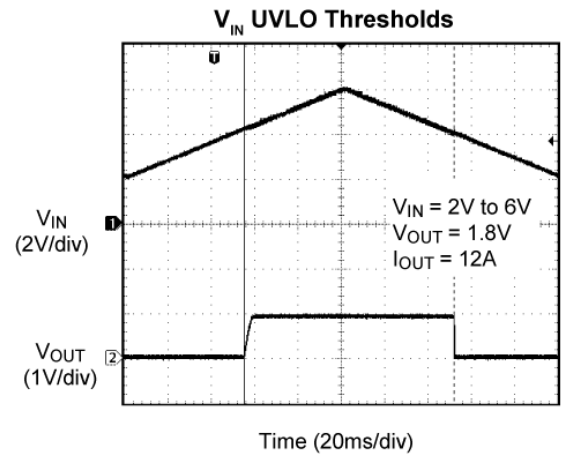
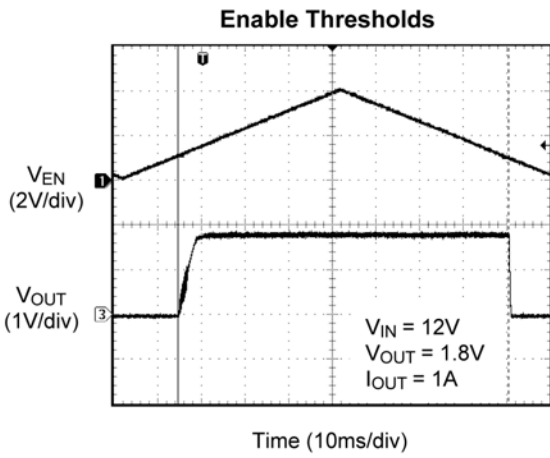

## Functional Characteristics (Continued)

**Peak Current Limit Threshold**

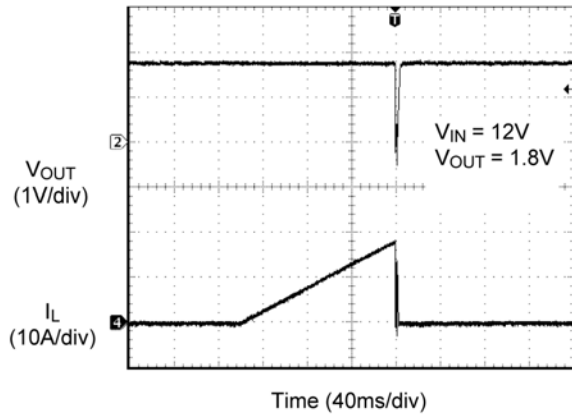

**Output Recovery from Thermal Shutdown**

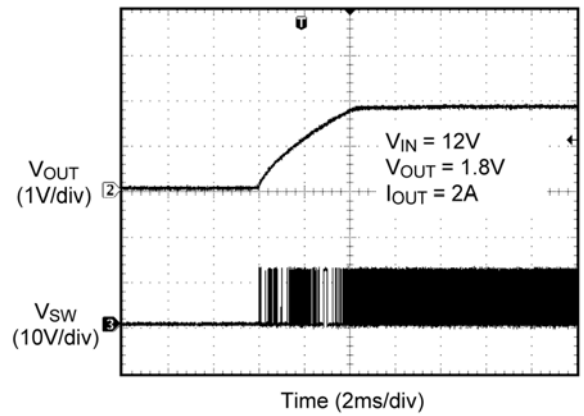

**Switching Waveform;  $I_{OUT} = 12A$**

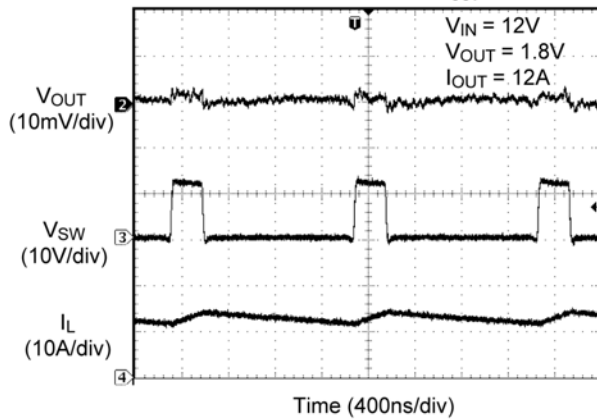

**Switching Waveform;  $I_{OUT} = 0A$**

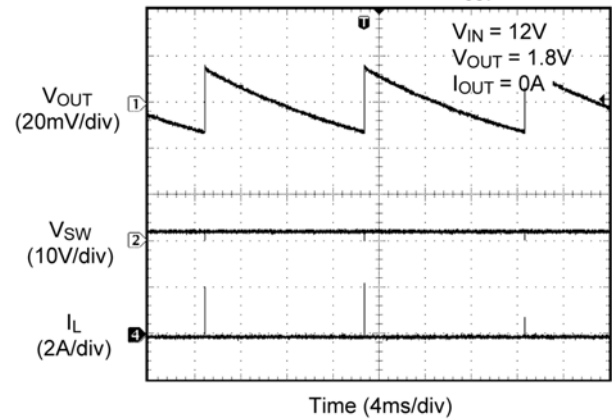

**Transient Response**

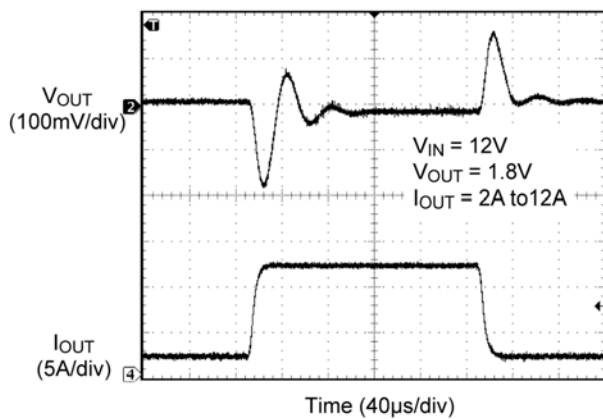

Functional Diagram

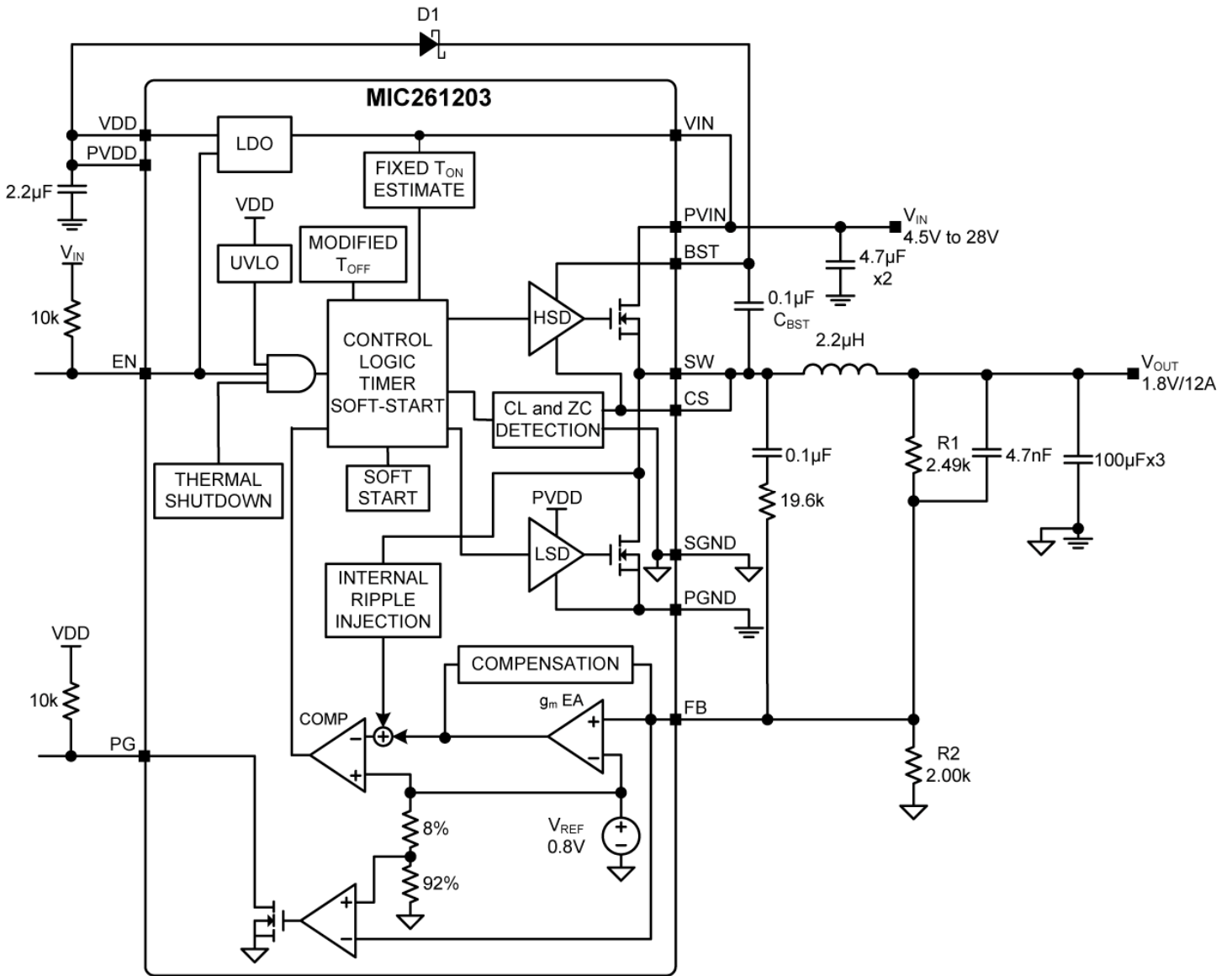

Figure 1. MIC261203 Block Diagram

## Functional Description

The MIC261203 is an adaptive ON-time synchronous step-down DC/DC regulator with an internal 5V linear regulator and a Power Good (PG) output. It is designed to operate over a wide input voltage range from 4.5V to 28V and provides a regulated output voltage at up to 7A of output current. An adaptive ON-time control scheme is employed in to obtain a constant switching frequency and to simplify the control compensation. Over-current protection is implemented without the use of an external sense resistor. The device includes an internal soft-start function which reduces the power supply input surge current at start-up by controlling the output voltage rise time.

### Theory of Operation

The MIC261203 is able to operate in either continuous mode or discontinuous mode. The operating mode is determined by the output of the Zero Cross comparator (ZC) as shown in Figure 1.

### Continuous Mode

In continuous mode, the output voltage is sensed by the MIC261203 feedback pin FB via the voltage divider R1 and R2, and compared to a 0.8V reference voltage  $V_{REF}$  at the error comparator through a low gain transconductance ( $g_m$ ) amplifier. If the feedback voltage decreases and the output of the  $g_m$  amplifier is below 0.8V, then the error comparator will trigger the control logic and generate an ON-time period. The ON-time period length is predetermined by the "FIXED  $t_{ON}$  ESTIMATION" circuitry:

$$t_{ON(estimated)} = \frac{V_{OUT}}{V_{IN} \times 600kHz} \quad \text{Eq. 1}$$

where  $V_{OUT}$  is the output voltage and  $V_{IN}$  is the power stage input voltage.

At the end of the ON-time period, the internal high-side driver turns off the high-side MOSFET and the low-side driver turns on the low-side MOSFET. The OFF-time period length depends upon the feedback voltage in most cases. When the feedback voltage decreases and the output of the  $g_m$  amplifier is below 0.8V, the ON-time period is triggered and the OFF-time period ends. If the OFF-time period determined by the feedback voltage is less than the minimum OFF-time  $t_{OFF(min)}$ , which is about 300ns, then the MIC261203 control logic will apply the  $t_{OFF(min)}$  instead.  $t_{OFF(min)}$  is required to maintain enough energy in the boost capacitor ( $C_{BST}$ ) to drive the high-side MOSFET.

The maximum duty cycle is obtained from the 300ns  $t_{OFF(min)}$ :

$$D_{max} = \frac{t_S - t_{OFF(min)}}{t_S} = 1 - \frac{300ns}{t_S} \quad \text{Eq. 2}$$

where  $t_S = 1/600kHz = 1.66\mu s$ .

It is not recommended to use MIC261203 with a OFF-time close to  $t_{OFF(min)}$  during steady-state operation. Also, as  $V_{OUT}$  increases, the internal ripple injection will increase and reduce the line regulation performance. Therefore, the maximum output voltage of the MIC261203 should be limited to 5.5V and the maximum external ripple injection should be limited to 200mV. Please refer to "Setting Output Voltage" subsection in *Application Information* for more details.

The actual ON-time and resulting switching frequency will vary with the part-to-part variation in the rise and fall times of the internal MOSFETs, the output load current, and variations in the  $V_{DD}$  voltage. Also, the minimum  $t_{ON}$  results in a lower switching frequency in high  $V_{IN}$  to  $V_{OUT}$  applications, such as 24V to 1.0V. The minimum  $t_{ON}$  measured on the MIC261203 evaluation board is about 100ns. During load transients, the switching frequency is changed due to the varying OFF-time.

To illustrate the control loop operation, both the steady-state and load transient scenarios will be analyzed.

Figure 2 shows the MIC261203 control loop timing during steady-state operation. During steady-state, the  $g_m$  amplifier senses the feedback voltage ripple, which is proportional to the output voltage ripple and the inductor current ripple, to trigger the ON-time period. The ON-time is predetermined by the  $t_{ON}$  estimator. The termination of the OFF-time is controlled by the feedback voltage. At the valley of the feedback voltage ripple, which occurs when  $V_{FB}$  falls below  $V_{REF}$ , the OFF period ends and the next ON-time period is triggered through the control logic circuitry.

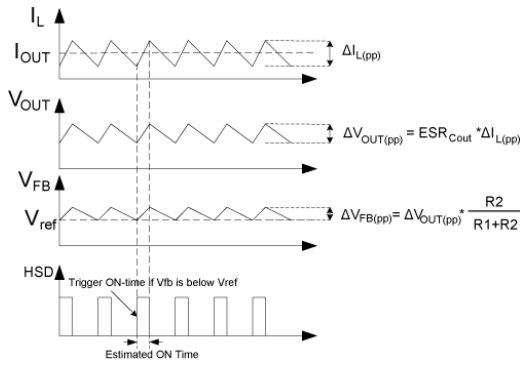

**Figure 2. MIC261203 Control Loop Timing**

Figure 3 shows the operation of the MIC261203 during a load transient. The output voltage drops due to the sudden load increase, which causes the  $V_{FB}$  to be less than  $V_{REF}$ . This will cause the error comparator to trigger an ON-time period. At the end of the ON-time period, a minimum OFF-time  $t_{OFF(min)}$  is generated to charge  $C_{BST}$  since the feedback voltage is still below  $V_{REF}$ . Then, the next ON-time period is triggered due to the low feedback voltage. Therefore, the switching frequency changes during the load transient, but returns to the nominal fixed frequency once the output has stabilized at the new load current level. With the varying duty cycle and switching frequency, the output recovery time is fast and the output voltage deviation is small in MIC261203 converter.

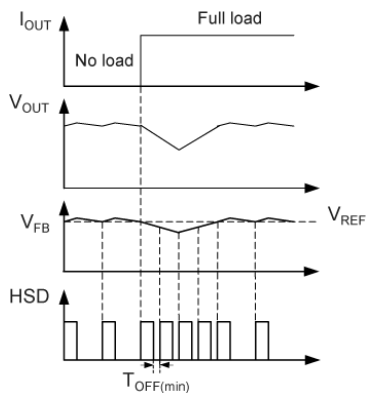

**Figure 3. MIC261203 Load Transient Response**

Unlike true current-mode control, the MIC261203 uses the output voltage ripple to trigger an ON-time period. The output voltage ripple is proportional to the inductor current ripple if the ESR of the output capacitor is large enough. The MIC261203 control loop has the advantage of eliminating the need for slope compensation.

In order to meet the stability requirements, the MIC261203 feedback voltage ripple should be in phase with the inductor current ripple and large enough to be sensed by the  $g_m$  amplifier and the error comparator. The recommended feedback voltage ripple is 20mV~100mV. If a low-ESR output capacitor is selected, then the feedback voltage ripple may be too small to be sensed by the  $g_m$  amplifier and the error comparator. Also, the output voltage ripple and the feedback voltage ripple are not necessarily in phase with the inductor current ripple if the ESR of the output capacitor is very low. In these cases, ripple injection is required to ensure proper operation. Please refer to “Ripple Injection” subsection in *Application Information* for more details about the ripple injection technique.

**Discontinuous Mode**

In continuous mode, the inductor current is always greater than zero; however, at light loads the MIC261203 is able to force the inductor current to operate in discontinuous mode. Discontinuous mode is where the inductor current falls to zero, as indicated by trace ( $I_L$ ) shown in Figure 4. During this period, the efficiency is optimized by shutting down all the non-essential circuits and minimizing the supply current. The MIC261203 wakes up and turns on the high-side MOSFET when the feedback voltage  $V_{FB}$  drops below 0.8V.

The MIC261203 has a zero crossing comparator that monitors the inductor current by sensing the voltage drop across the low-side MOSFET during its ON-time. If the  $V_{FB} > 0.8V$  and the inductor current goes slightly negative, then the MIC261203 automatically powers down most of the IC circuitry and goes into a low-power mode.

Once the MIC261203 goes into discontinuous mode, both LSD and HSD are low, which turns off the high-side and low-side MOSFETs. The load current is supplied by the output capacitors and  $V_{OUT}$  drops. If the drop of  $V_{OUT}$  causes  $V_{FB}$  to go below  $V_{REF}$ , then all the circuits will wake up into normal continuous mode. First, the bias currents of most circuits reduced during the discontinuous mode are restored, then a  $t_{ON}$  pulse is triggered before the drivers are turned on to avoid any possible glitches. Finally, the high-side driver is turned on. Figure 4 shows the control loop timing in discontinuous mode.



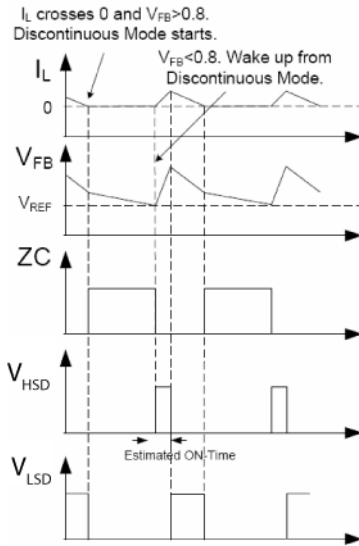

**Figure 4. MIC261203 Control Loop Timing (Discontinuous Mode)**

During discontinuous mode, the zero crossing comparator and the current limit comparator are turned off. The bias current of most circuits are reduced. As a result, the total power supply current during discontinuous mode is only about 450 $\mu$ A, allowing the MIC261203 to achieve high efficiency in light load applications.

**V<sub>DD</sub> Regulator**

The MIC261203 provides a 5V regulated output for input voltage V<sub>IN</sub> ranging from 5.5V to 28V. When V<sub>IN</sub> < 5.5V, V<sub>DD</sub> should be tied to PVIN pins to bypass the internal linear regulator.

**Soft-Start**

Soft-start reduces the power supply input surge current at startup by controlling the output voltage rise time. The input surge appears while the output capacitor is charged up. A slower output rise time will draw a lower input surge current.

The MIC261203 implements an internal digital soft-start by making the 0.8V reference voltage V<sub>REF</sub> ramp from 0 to 100% in about 5ms with 9.7mV steps. Therefore, the output voltage is controlled to increase slowly by a staircase V<sub>FB</sub> ramp. Once the soft-start cycle ends, the related circuitry is disabled to reduce current consumption. V<sub>DD</sub> must be powered up at the same time or after V<sub>IN</sub> to make the soft-start function correctly.

**Current Limit**

The MIC261203 uses the R<sub>DS(ON)</sub> of the internal low-side power MOSFET to sense over-current conditions. This method will avoid adding cost, board space and power losses taken by a discrete current sense resistor. The low-side MOSFET is used because it displays much lower parasitic oscillations during switching than the high-side MOSFET.

In each switching cycle of the MIC261203 converter, the inductor current is sensed by monitoring the low-side MOSFET in the OFF period. If the inductor current is greater than 26A, then the MIC261203 turns off the high-side MOSFET and a soft-start sequence is triggered. This mode of operation is called “hiccup mode” and its purpose is to protect the downstream load in case of a hard short. The load current-limit threshold has a fold back characteristic related to the feedback voltage as shown in Figure 5.

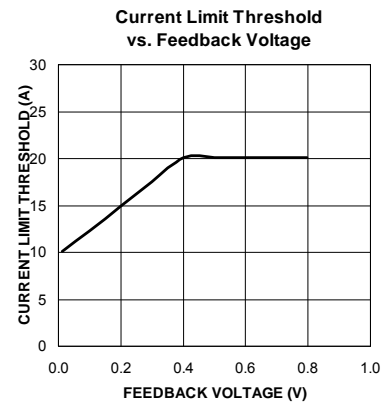

**Figure 5. MIC261203 Current-Limit Foldback Characteristic**

**Power Good (PG)**

The Power Good (PG) pin is an open drain output which indicates logic high when the output is nominally 92% of its steady state voltage. A pull-up resistor of more than 10k $\Omega$  should be connected from PG to V<sub>DD</sub>.

### MOSFET Gate Drive

The Block Diagram (Figure 1) shows a bootstrap circuit, consisting of D1 (a Schottky diode is recommended) and  $C_{BST}$ . This circuit supplies energy to the high-side drive circuit. Capacitor  $C_{BST}$  is charged, while the low-side MOSFET is on, and the voltage on the SW pin is approximately 0V. When the high-side MOSFET driver is turned on, energy from  $C_{BST}$  is used to turn the MOSFET on. As the high-side MOSFET turns on, the voltage on the SW pin increases to approximately  $V_{IN}$ . Diode D1 is reverse biased and  $C_{BST}$  floats high while continuing to keep the high-side MOSFET on. The bias current of the high-side driver is less than 10mA so a 0.1 $\mu$ F to 1 $\mu$ F is sufficient to hold the gate voltage with minimal droop for the power stroke (high-side switching) cycle, i.e.  $\Delta BST = 10\text{mA} \times 1.67\mu\text{s}/0.1\mu\text{F} = 167\text{mV}$ . When the low-side MOSFET is turned back on,  $C_{BST}$  is then recharged through D1. A small resistor  $R_G$ , which is in series with  $C_{BST}$ , can be used to slow down the turn-on time of the high-side N-channel MOSFET.

The drive voltage is derived from the  $V_{DD}$  supply voltage. The nominal low-side gate drive voltage is  $V_{DD}$  and the nominal high-side gate drive voltage is approximately  $V_{DD} - V_{DIODE}$ , where  $V_{DIODE}$  is the voltage drop across D1. An approximate 30ns delay between the high-side and low-side driver transitions is used to prevent current from simultaneously flowing unimpeded through both MOSFETs.

## Application Information

### Inductor Selection

Values for inductance, peak, and RMS currents are required to select the output inductor. The input and output voltages and the inductance value determine the peak-to-peak inductor ripple current. Generally, higher inductance values are used with higher input voltages. Larger peak-to-peak ripple currents will increase the power dissipation in the inductor and MOSFETs. Larger output ripple currents will also require more output capacitance to smooth out the larger ripple current. Smaller peak-to-peak ripple currents require a larger inductance value and therefore a larger and more expensive inductor. A good compromise between size, loss and cost is to set the inductor ripple current to be equal to 20% of the maximum output current. The inductance value is calculated by Equation 3:

$$L = \frac{V_{OUT} \times (V_{IN(max)} - V_{OUT})}{V_{IN(max)} \times f_{sw} \times 20\% \times I_{OUT(max)}} \quad \text{Eq. 3}$$

where:

$f_{sw}$  = switching frequency, 600kHz

20% = ratio of AC ripple current-to-DC output current

$V_{IN(max)}$  = maximum power stage input voltage

The peak-to-peak inductor current ripple is:

$$\Delta I_{L(pp)} = \frac{V_{OUT} \times (V_{IN(max)} - V_{OUT})}{V_{IN(max)} \times f_{sw} \times L} \quad \text{Eq. 4}$$

The peak inductor current is equal to the average output current plus one half of the peak-to-peak inductor current ripple.

$$I_{L(pk)} = I_{OUT(max)} + 0.5 \times \Delta I_{L(pp)} \quad \text{Eq. 5}$$

The RMS inductor current is used to calculate the  $I^2R$  losses in the inductor.

$$I_{L(RMS)} = \sqrt{I_{OUT(max)}^2 + \frac{\Delta I_{L(pp)}^2}{12}} \quad \text{Eq. 6}$$

Maximizing efficiency requires the proper selection of core material and minimizing the winding resistance. The high frequency operation of the MIC261203 requires the use of ferrite materials for all but the most cost sensitive applications. Lower cost iron powder cores may be used but the increase in core loss will reduce the efficiency of the power supply. This is especially noticeable at low output power. The winding resistance decreases efficiency at the higher output current levels. The winding resistance must be minimized although this usually comes at the expense of a larger inductor. The power dissipated in the inductor is equal to the sum of the core and copper losses. At higher output loads, the core losses are usually insignificant and can be ignored. At lower output currents, the core losses can be a significant contributor. Core loss information is usually available from the magnetics vendor. Copper loss in the inductor is calculated by Equation 7:

$$P_{INDUCTOR(Cu)} = I_{L(RMS)}^2 \times R_{WINDING} \quad \text{Eq. 7}$$

The resistance of the copper wire,  $R_{WINDING}$ , increases with the temperature. The value of the winding resistance used should be at the operating temperature.

$$P_{WINDING(Ht)} = R_{WINDING(20^\circ C)} \times (1 + 0.0042 \times (T_H - T_{20^\circ C})) \quad \text{Eq. 8}$$

where:

$T_H$  = temperature of wire under full load

$T_{20^\circ C}$  = ambient temperature

$R_{WINDING(20^\circ C)}$  = room temperature winding resistance (usually specified by the manufacturer)

### Output Capacitor Selection

The type of the output capacitor is usually determined by its equivalent series resistance (ESR). Voltage and RMS current capability are two other important factors for selecting the output capacitor. Recommended capacitor types are tantalum, low-ESR aluminum electrolytic, OSCON and POSCAP. The output capacitor's ESR is usually the main cause of the output ripple. The output capacitor ESR also affects the control loop from a stability point of view.

The maximum value of ESR is calculated:

$$ESR_{C_{OUT}} \leq \frac{\Delta V_{OUT(pp)}}{\Delta I_{L(pp)}} \quad \text{Eq. 9}$$

where:

$\Delta V_{OUT(pp)}$  = peak-to-peak output voltage ripple

$\Delta I_{L(pp)}$  = peak-to-peak inductor current ripple

The total output ripple is a combination of the ESR and output capacitance. The total ripple is calculated by Equation 10:

$$\Delta V_{OUT(pp)} = \sqrt{\left(\frac{\Delta I_{L(pp)}}{C_{OUT} \times f_{SW} \times 8}\right)^2 + (\Delta I_{L(pp)} \times ESR_{C_{OUT}})^2} \quad \text{Eq. 10}$$

where:

D = duty cycle

$C_{OUT}$  = output capacitance value

$f_{SW}$  = switching frequency

As described in the “Theory of Operation” subsection in the *Functional Description* section, the MIC261203 requires at least 20mV peak-to-peak ripple at the FB pin to make the  $g_m$  amplifier and the error comparator behave properly. Also, the output voltage ripple should be in phase with the inductor current. Therefore, the output voltage ripple caused by the output capacitors value should be much smaller than the ripple caused by the output capacitor ESR. If low-ESR capacitors, such as ceramic capacitors, are selected as the output capacitors, a ripple injection method should be applied to provide the enough feedback voltage ripple. Please refer to the “Ripple Injection” subsection for more details.

The voltage rating of the capacitor should be twice the output voltage for a tantalum and 20% greater for aluminum electrolytic or OS-CON. The output capacitor RMS current is calculated by Equation 11:

$$I_{C_{OUT}(RMS)} = \frac{\Delta I_{L(pp)}}{\sqrt{12}} \quad \text{Eq. 11}$$

The power dissipated in the output capacitor is:

$$P_{DISS(C_{OUT})} = I_{C_{OUT}(RMS)}^2 \times ESR_{C_{OUT}} \quad \text{Eq. 12}$$

### Input Capacitor Selection

The input capacitor for the power stage input  $V_{IN}$  should be selected for ripple current rating and voltage rating. Tantalum input capacitors may fail when subjected to high inrush currents, caused by turning the input supply on. A tantalum input capacitor’s voltage rating should be at least two times the maximum input voltage to maximize reliability. Aluminum electrolytic, OS-CON, and multilayer polymer film capacitors can handle the higher inrush currents without voltage de-rating. The input voltage ripple will primarily depend on the input capacitor’s ESR. The peak input current is equal to the peak inductor current, so:

$$\Delta V_{IN} = I_{L(pk)} \times ESR_{C_{IN}} \quad \text{Eq. 13}$$

The input capacitor must be rated for the input current ripple. The RMS value of input capacitor current is determined at the maximum output current. Assuming the peak-to-peak inductor current ripple is low:

$$I_{C_{IN}(RMS)} \approx I_{OUT(max)} \times \sqrt{D \times (1-D)} \quad \text{Eq. 14}$$

The power dissipated in the input capacitor is:

$$P_{DISS(C_{IN})} = I_{C_{IN}(RMS)}^2 \times ESR_{C_{IN}} \quad \text{Eq. 15}$$

### Ripple Injection

The  $V_{FB}$  ripple required for proper operation of the MIC261203  $g_m$  amplifier and error comparator is 20mV to 100mV. However, the output voltage ripple is generally designed as 1% to 2% of the output voltage. For a low output voltage, such as a 1V, the output voltage ripple is only 10mV to 20mV, and the feedback voltage ripple is less than 20mV. If the feedback voltage ripple is so small that the  $g_m$  amplifier and error comparator can’t sense it, then the MIC261203 will lose control and the output voltage is not regulated. In order to have some amount of  $V_{FB}$  ripple, a ripple injection method is applied for low output voltage ripple applications.

The applications are divided into three situations according to the amount of the feedback voltage ripple:

1. Enough ripple at the feedback voltage due to the large ESR of the output capacitors.

As shown in Figure 6a, the converter is stable without any ripple injection. The feedback voltage ripple is:

$$\Delta V_{FB(pp)} = \frac{R2}{R1 + R2} \times ESR_{C_{OUT}} \times \Delta I_{L(pp)} \quad \text{Eq. 16}$$

where  $\Delta I_{L(pp)}$  is the peak-to-peak value of the inductor current ripple.

2. Inadequate ripple at the feedback voltage due to the small ESR of the output capacitors.

The output voltage ripple is fed into the FB pin through a feedforward capacitor  $C_{ff}$  in this situation, as shown in Figure 6b. The typical  $C_{ff}$  value is between 1nF and 100nF. With the feedforward capacitor, the feedback voltage ripple is very close to the output voltage ripple:

$$\Delta V_{FB(pp)} \approx ESR \times \Delta I_{L(pp)} \quad \text{Eq. 17}$$

3. Virtually no ripple at the FB pin voltage due to the very-low ESR of the output capacitors.

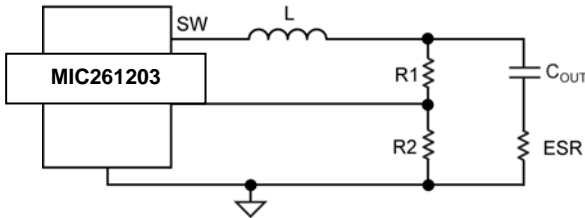

Figure 6a. Enough Ripple at FB

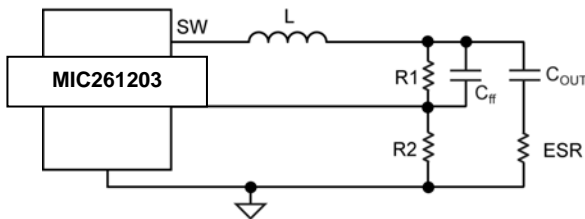

Figure 6b. Inadequate Ripple at FB

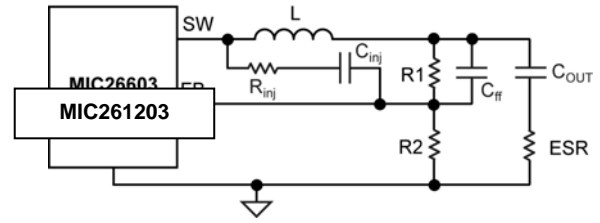

Figure 6c. Invisible Ripple at FB

In this situation, the output voltage ripple is less than 20mV. Therefore, additional ripple is injected into the FB pin from the switching node SW via a resistor  $R_{inj}$  and a capacitor  $C_{inj}$ , as shown in Figure 6c. The injected ripple is:

$$\Delta V_{FB(pp)} = V_{IN} \times K_{div} \times D \times (1-D) \times \frac{1}{f_{SW} \times \tau} \quad \text{Eq. 18}$$

$$K_{div} = \frac{R1/R2}{R_{inj} + R1/R2} \quad \text{Eq. 19}$$

where

$V_{IN}$  = Power stage input voltage

$D$  = duty cycle

$f_{SW}$  = switching frequency

$$\tau = (R1/R2/R_{inj}) \times C_{ff}$$

In Equations 21 and 22, it is assumed that the time constant associated with  $C_{ff}$  must be much greater than the switching period:

$$\frac{1}{f_{SW} \times \tau} = \frac{T}{T} \ll 1 \quad \text{Eq. 20}$$

If the voltage divider resistors  $R1$  and  $R2$  are in the k $\Omega$  range, a  $C_{ff}$  of 1nF to 100nF can easily satisfy the large time constant requirements. Also, a 100nF injection capacitor  $C_{inj}$  is used in order to be considered as short for a wide range of the frequencies.

The process of sizing the ripple injection resistor and capacitors is:

**Step 1.** Select  $C_{ff}$  to feed all output ripples into the feedback pin and make sure the large time constant assumption is satisfied. Typical choice of  $C_{ff}$  is 1nF to 100nF if R1 and R2 are in kΩ range.

**Step 2.** Select  $R_{inj}$  according to the expected feedback voltage ripple using Equation 22:

$$K_{div} = \frac{\Delta V_{FB(pp)}}{V_{IN}} \times \frac{f_{SW} \times T}{D \times (1-D)} \quad \text{Eq. 21}$$

Then the value of  $R_{inj}$  is obtained as:

$$R_{inj} = (R1//R2) \times \left( \frac{1}{K_{div}} - 1 \right) \quad \text{Eq. 22}$$

**Step 3.** Select  $C_{inj}$  as 100nF, which could be considered as short for a wide range of the frequencies.

### Setting Output Voltage

The MIC261203 requires two resistors to set the output voltage as shown in Figure 7.

The output voltage is determined by Equation 23:

$$V_{OUT} = V_{FB} \times \left( 1 + \frac{R1}{R2} \right) \quad \text{Eq. 23}$$

where  $V_{FB} = 0.8V$ .

A typical value of R1 can be between 3kΩ and 10kΩ. If R1 is too large, it may allow noise to be introduced into the voltage feedback loop. If R1 is too small, it will decrease the efficiency of the power supply, especially at light loads. Once R1 is selected, R2 can be calculated using:

$$R2 = \frac{V_{FB} \times R1}{V_{OUT} - V_{FB}} \quad \text{Eq. 24}$$

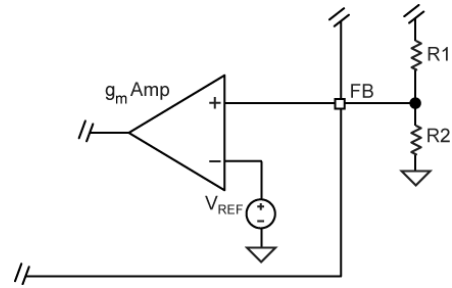

Figure 7. Voltage-Divider Configuration

In addition to the external ripple injection added at the FB pin, internal ripple injection is added at the inverting input of the comparator inside the MIC261203, as shown in Figure 8. The inverting input voltage  $V_{INJ}$  is clamped to 1.2V. As  $V_{OUT}$  is increased, the swing of  $V_{INJ}$  will be clamped. The clamped  $V_{INJ}$  reduces the line regulation because it is reflected as a DC error on the FB terminal. Therefore, the maximum output voltage of the MIC261203 should be limited to 5.5V to avoid this problem.

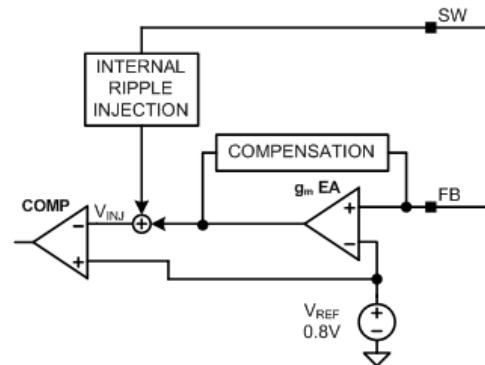

Figure 8. Internal Ripple Injection

**Thermal Measurements**

Measuring the IC's case temperature is recommended to insure it is within its operating limits. Although this might seem like a very elementary task, it is easy to get erroneous results. The most common mistake is to use the standard thermal couple that comes with a thermal meter. This thermal couple wire gauge is large, typically 22 gauge, and behaves like a heatsink, resulting in a lower case measurement.

Two methods of temperature measurement are using a smaller thermal couple wire or an infrared thermometer. If a thermal couple wire is used, it must be constructed of 36 gauge wire or higher then (smaller wire size) to minimize the wire heat-sinking effect. In addition, the thermal couple tip must be covered in either thermal grease or thermal glue to make sure that the thermal couple junction is making good contact with the case of the IC. Omega brand thermal couple (5SC-TT-K-36-36) is adequate for most applications.

Wherever possible, an infrared thermometer is recommended. The measurement spot size of most infrared thermometers is too large for an accurate reading on a small form factor ICs. However, a IR thermometer from Optris has a 1mm spot size, which makes it a good choice for measuring the hottest point on the case. An optional stand makes it easy to hold the beam on the IC for long periods of time.

## PCB Layout Guidelines

**Warning!!! To minimize EMI and output noise, follow these layout recommendations.**

PCB Layout is critical to achieve reliable, stable and efficient performance. A ground plane is required to control EMI and minimize the inductance in power, signal and return paths.

The following guidelines should be followed to insure proper operation of the MIC261203 regulator.

### IC

- A 2.2 $\mu$ F ceramic capacitor, which is connected to the PVDD pin, must be located right at the IC. The PVDD pin is very noise sensitive and placement of the capacitor is very critical. Use wide traces to connect to the PVDD and PGND pins.
- A 1.0 $\mu$ F ceramic capacitor must be placed right between VDD and the signal ground SGND. The SGND must be connected directly to the ground planes. Do not route the SGND pin to the PGND Pad on the top layer.
- Place the IC close to the point-of-load (POL).
- Use fat traces to route the input and output power lines.
- Signal and power grounds should be kept separate and connected at only one location.

### Input Capacitor

- Place the input capacitor next.
- Place the input capacitors on the same side of the board and as close to the IC as possible.
- Keep both the PVIN pin and PGND connections short.
- Place several vias to the ground plane close to the input capacitor ground terminal.
- Use either X7R or X5R dielectric input capacitors. Do not use Y5V or Z5U type capacitors.
- Do not replace the ceramic input capacitor with any other type of capacitor. Any type of capacitor can be placed in parallel with the input capacitor.
- If a Tantalum input capacitor is placed in parallel with the input capacitor, it must be recommended for switching regulator applications and the operating voltage must be derated by 50%.
- In "Hot-Plug" applications, a Tantalum or Electrolytic bypass capacitor must be used to limit the over-voltage spike seen on the input supply with power is suddenly applied.

### Inductor

- Keep the inductor connection to the switch node (SW) short.
- Do not route any digital lines underneath or close to the inductor.
- Keep the switch node (SW) away from the feedback (FB) pin.
- The CS pin should be connected directly to the SW pin to accurately sense the voltage across the low-side MOSFET.
- To minimize noise, place a ground plane underneath the inductor.
- The inductor can be placed on the opposite side of the PCB with respect to the IC. It does not matter whether the IC or inductor is on the top or bottom as long as there is enough air flow to keep the power components within their temperature limits. The input and output capacitors must be placed on the same side of the board as the IC.

### Output Capacitor

- Use a wide trace to connect the output capacitor ground terminal to the input capacitor ground terminal.
- Phase margin will change as the output capacitor value and ESR changes. Contact the factory if the output capacitor is different from what is shown in the BOM.
- The feedback trace should be separate from the power trace and connected as close as possible to the output capacitor. Sensing a long high current load trace can degrade the DC load regulation.

### Optional RC Snubber

- Place the RC snubber on either side of the board and as close to the SW pin as possible.



# Evaluation Board Schematic

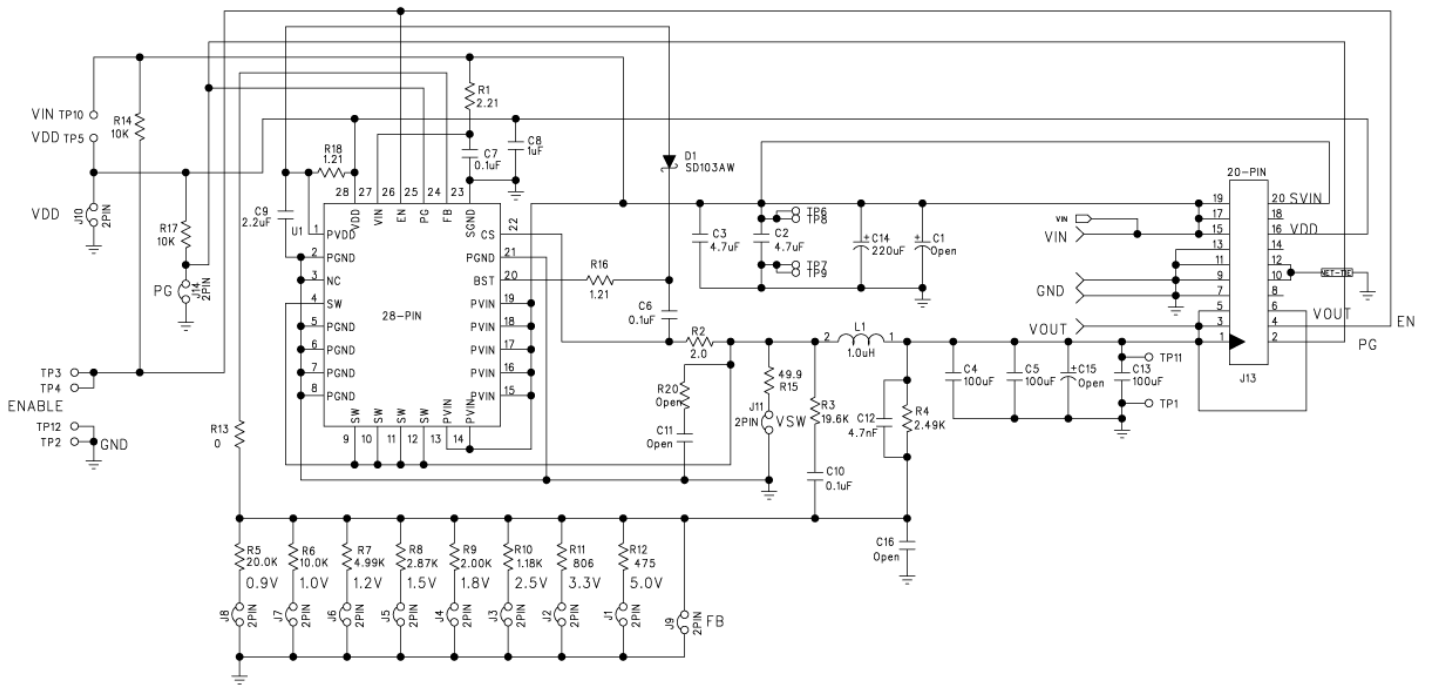

**Figure 9. Schematic of MIC261203 Evaluation Board**  
**(J11, R13, R15 are for testing purposes)**

**Bill of Materials**

Item	Part Number	Manufacturer	Description	Qty.
C1	Open			
C2, C3	12105C475KAZ2A	AVX <sup>(1)</sup>	4.7µF Ceramic Capacitor, X7R, Size 1210, 50V	2
	GRM32ER71H475KA88L	Murata <sup>(2)</sup>		
	C3225X7R1H475K	TDK <sup>(3)</sup>		
C15	Open			
C4, C5, C13	12106D107MAT2A	AVX <sup>(1)</sup>	100µF Ceramic Capacitor, X5R, Size 1210, 6.3V	3
	GRM32ER60J107ME20L	Murata <sup>(2)</sup>		
	C3225X5R0J107M	TDK <sup>(3)</sup>		
C6, C7, C10	06035C104KAT2A	AVX <sup>(1)</sup>	0.1µF Ceramic Capacitor, X7R, Size 0603, 50V	3
	GRM188R71H104KA93D	Murata <sup>(2)</sup>		
	C1608X7R1H104K	TDK <sup>(3)</sup>		
C8	0603ZC105KAT2A	AVX <sup>(1)</sup>	1.0µF Ceramic Capacitor, X7R, Size 0603, 10V	1
	GRM188R71A105KA61D	Murata <sup>(2)</sup>		
	C1608X7R1A105K	TDK <sup>(3)</sup>		
C9	0603ZD225KAT2A	AVX <sup>(1)</sup>	2.2µF Ceramic Capacitor, X5R, Size 0603, 10V	1
	GRM188R61A225KE34D	Murata <sup>(2)</sup>		
	C1608X5R1A225K	TDK <sup>(3)</sup>		
C12	06035C472KAZ2A	AVX <sup>(1)</sup>	4.7nF Ceramic Capacitor, X7R, Size 0603, 50V	1
	GRM188R71H472K	Murata <sup>(2)</sup>		
	C1608X7R1H472K	TDK <sup>(3)</sup>		
C14	B41851F7227M	EPCOS <sup>(4)</sup>	220µF Aluminum Capacitor, 35V	1
C11, C16	Open			
D1	SD103AWS	MCC <sup>(5)</sup>	40V, 350mA, Schottky Diode, SOD323	1
	SD103AWS-7	Diodes Inc <sup>(6)</sup>		
	SD103AWS	Vishay <sup>(7)</sup>		
L1	HCF1305-1R0-R	Cooper Bussmann <sup>(8)</sup>	1.0µH Inductor, 21A Saturation Current	1
R1	CRCW06032R21FKEA	Vishay Dale <sup>(7)</sup>	2.21Ω Resistor, Size 0603, 1%	1
R2	CRCW06032R00FKEA	Vishay Dale <sup>(7)</sup>	2.00Ω Resistor, Size 0603, 1%	1
R3	CRCW060319K6FKEA	Vishay Dale <sup>(7)</sup>	19.6kΩ Resistor, Size 0603, 1%	1
R4	CRCW06032K49FKEA	Vishay Dale <sup>(7)</sup>	2.49kΩ Resistor, Size 0603, 1%	1
R5	CRCW060320K0FKEA	Vishay Dale <sup>(7)</sup>	20.0kΩ Resistor, Size 0603, 1%	1
R6, R14, R17	CRCW060310K0FKEA	Vishay Dale <sup>(7)</sup>	10.0kΩ Resistor, Size 0603, 1%	3
R7	CRCW06034K99FKEA	Vishay Dale <sup>(7)</sup>	4.99kΩ Resistor, Size 0603, 1%	1
R8	CRCW06032K87FKEA	Vishay Dale <sup>(7)</sup>	2.87kΩ Resistor, Size 0603, 1%	1
R9	CRCW06032K006FKEA	Vishay Dale <sup>(7)</sup>	2.00kΩ Resistor, Size 0603, 1%	1
R10	CRCW06031K18FKEA	Vishay Dale <sup>(7)</sup>	1.18kΩ Resistor, Size 0603, 1%	1
R11	CRCW0603806RFKEA	Vishay Dale <sup>(7)</sup>	806Ω Resistor, Size 0603, 1%	1
R12	CRCW0603475RFKEA	Vishay Dale <sup>(7)</sup>	475Ω Resistor, Size 0603, 1%	1

**Bill of Materials (Continued)**

Item	Part Number	Manufacturer	Description	Qty.
R13	CRCW06030000FKEA	Vishay Dale <sup>(7)</sup>	0Ω Resistor, Size 0603, 5%	1
R15	CRCW060349R9FKEA	Vishay Dale <sup>(7)</sup>	49.9Ω Resistor, Size 0603, 1%	1
R16, R18	CRCW06031R21FKEA	Vishay Dale <sup>(7)</sup>	1.21Ω Resistor, Size 0603, 1%	2
R20	Open			
<b>U1</b>	<b>MIC261203YJL</b>	<b>Micrel, Inc.<sup>(9)</sup></b>	<b>28V, 12A Hyper Light Load™ Synchronous DC/DC Buck Regulator</b>	<b>1</b>

**Notes:**

1. AVX: [www.avx.com](http://www.avx.com).
2. Murata: [www.murata.com](http://www.murata.com).
3. TDK: [www.tdk.com](http://www.tdk.com).
4. EPCOS: [www.epcos.com](http://www.epcos.com).
5. SANYO: [www.sanyo.com](http://www.sanyo.com).
6. Diode Inc.: [www.diodes.com](http://www.diodes.com).
7. Vishay: [www.vishay.com](http://www.vishay.com).
8. Cooper Bussmann: [www.cooperbussmann.com](http://www.cooperbussmann.com).
9. **Micrel, Inc.:** [www.micrel.com](http://www.micrel.com).

# PCB Layout Recommendations

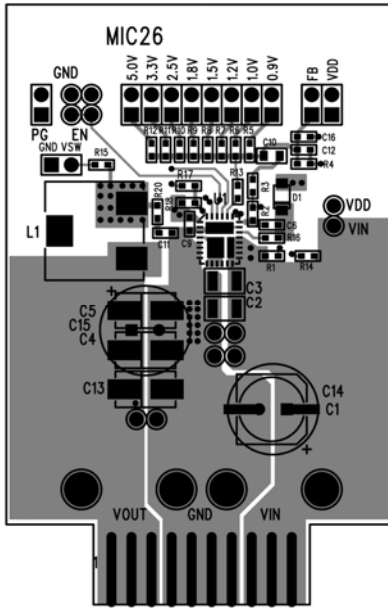

Figure 10. MIC261203 Evaluation Board Top Layer

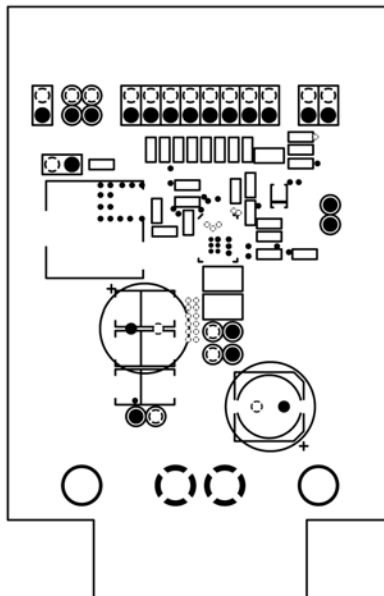

Figure 11. MIC261203 Evaluation Board Mid-Layer 1 (Ground Plane)

## PCB Layout Recommendations (Continued)

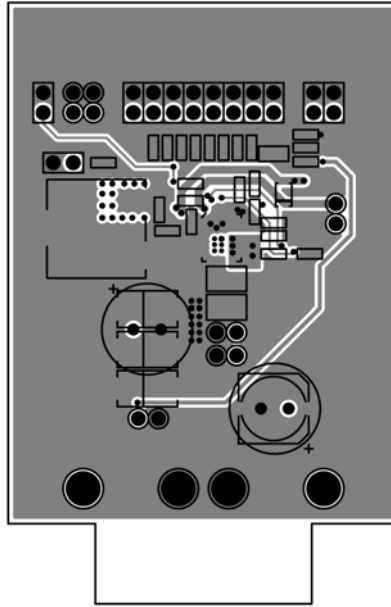

Figure 12. MIC261203 Evaluation Board Mid-Layer 2

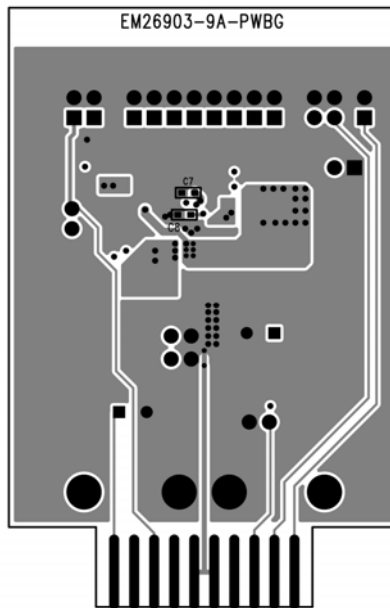
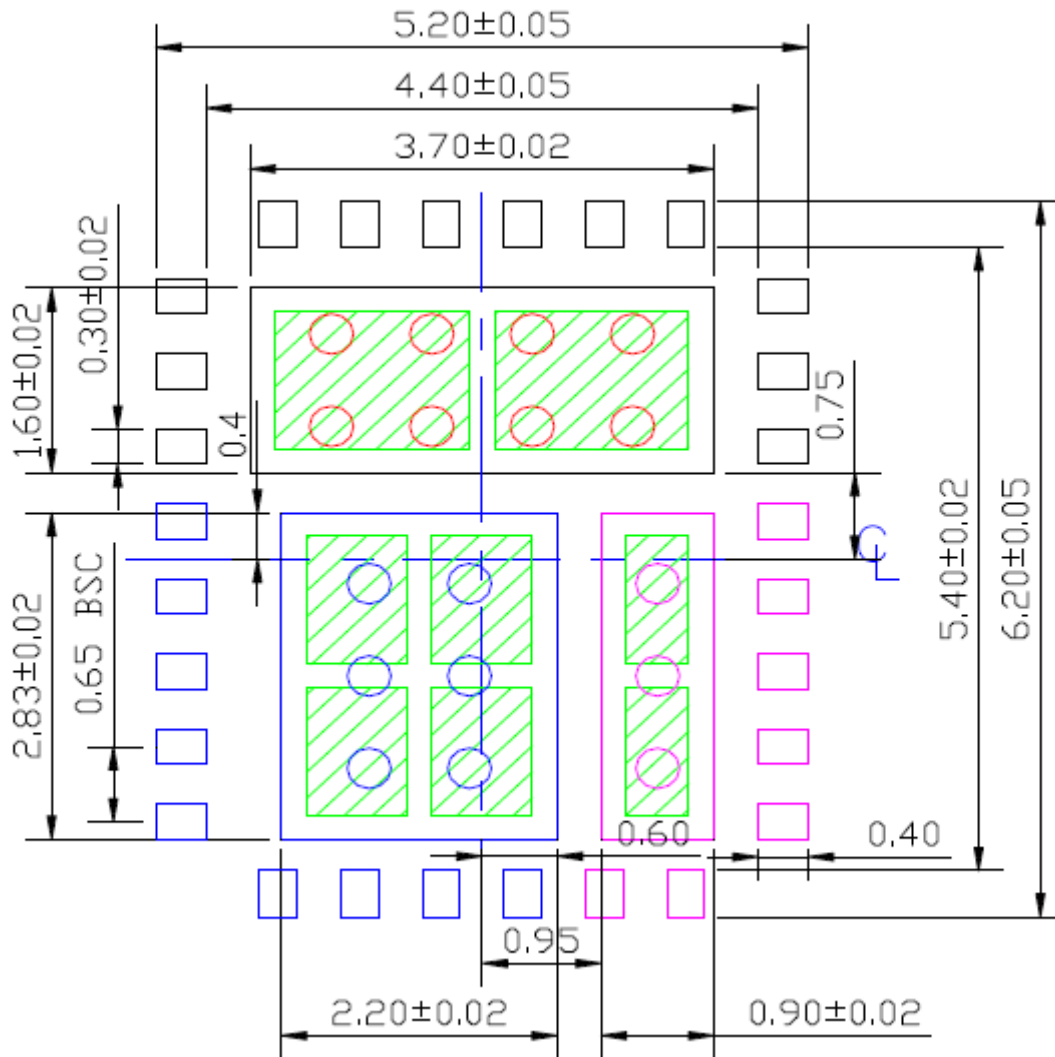

Figure 13. MIC261203 Evaluation Board Bottom Layer

### Recommended Land and Solder Stencil Pattern



**Red circle** indicates Thermal Via. Size should be .300-.350 mm in diameter, 0.80 mm pitch, and it should be connected to GND plane for maximum thermal performance.

**Green rectangle (with shaded area)** indicates Solder Stencil Opening on exposed pad area. Sizes should be a) 1.55x1.20 mm, 1.75 mm pitch, b) 0.80x1.11 mm, 1.31 mm pitch, c) 0.50x1.11 mm, 1.31 mm pitch.

Package Information

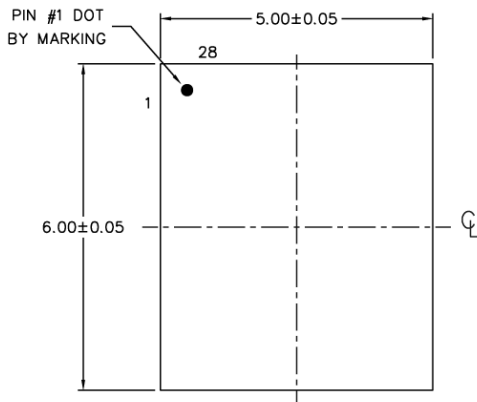

TOP VIEW

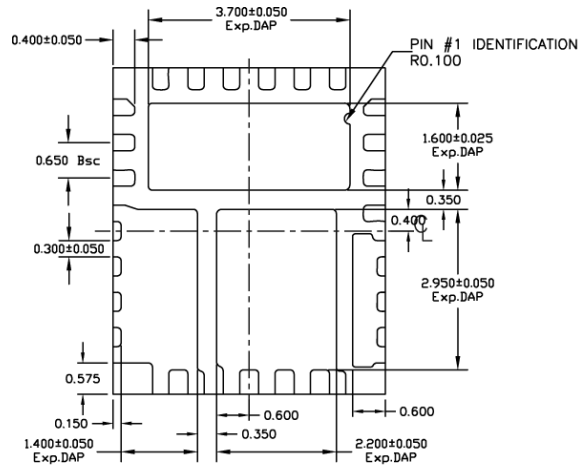

BOTTOM VIEW

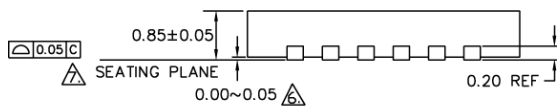

SIDE VIEW

- NOTE:
1. ALL DIMENSIONS ARE IN MILLIMETERS.
  2. MAX. PACKAGE WARPAGE IS 0.05 mm.
  3. MAXIMUM ALLOWABLE BURRS IS 0.076 mm IN ALL DIRECTIONS.
  4. PIN #1 ID ON TOP WILL BE LASER/INK MARKED.
- ⚠ DIMENSION APPLIES TO METALIZED TERMINAL AND IS MEASURED BETWEEN 0.20 AND 0.25 mm FROM TERMINAL TIP.
  - ⚠ APPLIED ONLY FOR TERMINALS.
  - ⚠ APPLIED FOR EXPOSED PAD AND TERMINALS.

28-Pin 5mm x 6mm MLF® (YJL)

MICREL, INC. 2180 FORTUNE DRIVE SAN JOSE, CA 95131 USA  
 TEL +1 (408) 944-0800 FAX +1 (408) 474-1000 WEB <http://www.micrel.com>

Micrel makes no representations or warranties with respect to the accuracy or completeness of the information furnished in this data sheet. This information is not intended as a warranty and Micrel does not assume responsibility for its use. Micrel reserves the right to change circuitry, specifications and descriptions at any time without notice. No license, whether express, implied, arising by estoppel or otherwise, to any intellectual property rights is granted by this document. Except as provided in Micrel's terms and conditions of sale for such products, Micrel assumes no liability whatsoever, and Micrel disclaims any express or implied warranty relating to the sale and/or use of Micrel products including liability or warranties relating to fitness for a particular purpose, merchantability, or infringement of any patent, copyright or other intellectual property right.

Micrel Products are not designed or authorized for use as components in life support appliances, devices or systems where malfunction of a product can reasonably be expected to result in personal injury. Life support devices or systems are devices or systems that (a) are intended for surgical implant into the body or (b) support or sustain life, and whose failure to perform can be reasonably expected to result in a significant injury to the user. A Purchaser's use or sale of Micrel Products for use in life support appliances, devices or systems is a Purchaser's own risk and Purchaser agrees to fully indemnify Micrel for any damages resulting from such use or sale.