

Cree® LMD125 LED Module Drivers



PRODUCT DESCRIPTION

Cree LED modules provide lighting designers and manufacturers with simple, easy-to-adopt LED lighting solutions that reduce luminaire development time and speed time-to-market. Cree LMD125 LED module drivers are specifically designed to work with the Cree LMH2 850- and 1250-lumen light sources to jump-start the design process for recessed downlights, wall sconces or pendant lights in demanding end markets such as retail, museums, hospitality and restaurants.

FEATURES

- Input voltages options: 100-120 V, 230 V & 277 V
- TRIAC dimming support for 100-120 V and 230 V options
- Optimized for Cree LMH2 850-lm & 1250-lm light sources
- LMD125 100-120 V driver is PSE certified

TABLE OF CONTENTS

Order Codes.....	2
Characteristics - LMD125 100- to 120-V Driver.....	2
Characteristics - LMD125 230-V Driver	2
Characteristics - LMD125 277-V Driver	3
Dimming	3
Mechanical Dimensions	8
Wiring Diagrams.....	9
Thermal Design.....	10
Emergency Battery Operation	11
Safety and Regulatory Notes.....	11
Packaging.....	12



ORDER CODES

Nominal Input Voltage (VAC)	Frequency (Hz)	Typical Output Current (mA)	Dimming	Order Code
100-120	50/60	440	TRIAC	LMD125-0018-C440-1010000
230	50/60	440	TRIAC	LMD125-0018-C440-2010000
277	60	440	N/A	LMD125-0017-C440-3000000

CHARACTERISTICS - LMD125 100- TO 120-V DRIVER

Order Code: LMD125-0018-C440-1010000

Characteristics	Unit	Minimum	Typical	Maximum
Input voltage range	VAC	90	120	132
Input power	W			18
Output current	mA		440	
Output voltage	V	21		35
Driver efficacy (@ 55 °C) - with LMH2 850-lm light source	%		80	
Driver efficacy (@ 55 °C) - with LMH2 1250-lm light source	%		81	
Power factor - with LMH2 850-lm light source			0.97	
Power factor - with LMH2 1250-lm light source			0.99	
LED driver case temperature	°C	0		80

CHARACTERISTICS - LMD125 230-V DRIVER

Order Code: LMD125-0018-C440-2010000

Characteristics	Unit	Minimum	Typical	Maximum
Input voltage range	VAC	207	230	253
Input power	W			18
Output current	mA		440	
Output voltage	V			37
Driver efficacy (@ 55 °C) - with LMH2 850-lm light source	%		80	
Driver efficacy (@ 55 °C) - with LMH2 1250-lm light source	%		81	
Power factor - with LMH2 850-lm light source			0.90	
Power factor - with LMH2 1250-lm light source			0.95	
LED driver case temperature	°C	0		80

- 3-D models (.STEP files) for the LMD125 LED module drivers are available on the Cree website by selecting the Documentation tab on the [LMH2 product page](#).

CHARACTERISTICS - LMD125 277-V DRIVER

Order Code: LMD125-0017-C440-3000000

Characteristics	Unit	Minimum	Typical	Maximum
Input voltage range	VAC	249	277	305
Input power	W			17
Output current	mA		440	
Output voltage	V	21		35
Driver efficacy (@ 55 °C) - with LMH2 850-lm light source	%		84	
Driver efficacy (@ 55 °C) - with LMH2 1250-lm light source	%		84	
Power factor - with LMH2 850-lm light source			0.92	
Power factor - with LMH2 1250-lm light source			0.98	
LED driver case temperature	°C	0		80

- 3-D models (.STEP files) for the LMD125 LED module drivers are available on the Cree website by selecting the Documentation tab on the [LMH2 product page](#).

DIMMING

The LMH2 850- and 1250-lm light sources combined with the LMD125 100- to 120-V and 230-V drivers work with standard leading- and trailing-edge dimming technologies to reduce light levels down to 5%.

Driver	Input Voltage	Dimming	Lowest Light Level
LMD125	100-120 V	TRIAC	5%
	230 V	TRIAC	5%
	277 V	None	-

Note - Most residential dimmers are designed to control 600 to 1000 watts of power with standard lighting technologies, i.e., incandescent and halogen. Because the LMH2 LED module has a much higher efficacy (lumens per watt) than standard lighting fixtures, it requires much less power. There may be some cases that require the use of more than one LMH2 LED module or lighting fixture on a single dimmer to achieve the minimum dimmer load. This depends heavily upon the particular dimmer used. Partial lists of compatible dimmers are provided below.

100-VAC Dimmer Compatibility with WhiteLight Dimming

Manufacturer	Model/Series	Part Number	Type	Compatible with 1 LMH2	Compatible with 2 LMH2s	Compatible with 3 LMH2s
Cooper		6020	IND	✓	✓	✓
		DI10P	IND	✓	✓	✓
		SI061-V	IND	✓	✓	✓
		SLC03P	CFL/IND	✓	✓	✓

Manufacturer	Model/Series	Part Number	Type	Compatible with 1 LMH2	Compatible with 2 LMH2s	Compatible with 3 LMH2s
Leviton	Acenti	ACE06	ELV	✓	✓	✓
	Acenti	AT106-1LW	IND	✓	✓	✓
	Decora	6631-LW	IND	✓	✓	✓
	Illumatech	IPI06	IND	✓	✓	✓
	Illumatech	IP110	IND	✓	✓	✓
	Mural	MDE03-1	ELV	✓	✓	✓
	Vizia	VP106	IND	✓	✓	✓
	Vizia	VPE04	IND	✓	✓	✓
Lutron	Ceana	CN-600P	IND	✓	✓	✓
	Ceana	CNLV-V-600P	MLV	✓	✓	✓
	Centurion	C-600	IND	✓	✓	✓
	Decora	HCM06-1DW	IND/MLV	✓	✓	✓
	Diva	DV-10P	IND	✓	✓	✓
	Diva	DV-600P	IND	✓	✓	✓
	Diva	DVELV-300P	ELV	✓	✓	✓
	Diva	DVLV-600P	MLV	✓	✓	✓
	Diva	DVWCL-153DH	CFL/LED	✓	✓	✓
	Faetra	FAELV-500	ELV	✓	✓	✓
	Glyder	GL-600M	IND/HAL	✓	✓	✓
	Lumea	LG-603PG	IND	✓	✓	✓
	Lyneo	LX-600PL	IND	✓	✓	✓
	Maestro	MA-1000	IND		✓	✓
	Maestro	MACL-153M	CFL/LED	✓	✓	✓
	Maestro	MAELV-600	MLV	✓	✓	✓
	Maestro	MAW-600	IND		✓	✓
	Nova	N-600	IND	✓	✓	✓
	Nova	NLV-1503P	MLV	✓	✓	✓
	Nova T	NT-603P	IND	✓	✓	✓
	Nova T	NTB-600	IND	✓	✓	✓
	Nova T	NTELV-600	ELV	✓	✓	✓
	RadioRA2	RRD-6NA	IND/ELV/HAL/MLV	✓	✓	
	Skylark	S2-L	INC/HAL	✓	✓	
	Skylark	S-600	IND	✓	✓	✓
	Skylark	SF-10P	FLR	✓	✓	✓
	Skylark	SELV-300P	ELV	✓	✓	✓
	Skylark	SLV-600P	MLV	✓	✓	✓
	Sureslide	6673-P	CFL	✓	✓	✓
	Toggler	TG-600PR-W4	IND/MLV	✓	✓	✓
Pass and Seymour		90680-W	IND	✓	✓	✓
		LS600	IND	✓	✓	✓
Wattstopper		MCD267-W	UNI	✓	✓	✓

CFL = Compact fluorescent dimmer
 ELV = Electronic low-voltage dimmer

IND = Incandescent dimmer
 LED = Light-emitting diode dimmer

FLR = Fluorescent dimmer

HAL = Halogen dimmer

MLV = Magnetic low-voltage dimmer

UNI = Universal dimmer

The presence of a dimmer in the above table is not a guarantee or warranty of the compatibility of the LMH2 product family in any particular installation. The absence of a dimmer from the tables does not necessarily imply incompatibility. Please refer to the dimmer manufacturer's instructions for installation and further product information.

120-VAC Dimmer Compatibility with WhiteLight Dimming

Manufacturer	Model/Series	Part Number	Type	Compatible with 1 LMH2	Compatible with 2 LMH2s	Compatible with 3 LMH2s
Cooper		6020	IND	✓	✓	✓
		DI06-V	IND	✓	✓	✓
		DI10P	IND	✓	✓	✓
Leviton	Acenti	ACE06	ELV	✓	✓	✓
	Acenti	AT106-1LW	IND	✓	✓	✓
	Illumatech	IPI06	IND	✓	✓	✓
	Illumatech	IP110	IND	✓	✓	✓
	Mural	MDE03-1	ELV	✓	✓	✓
	Vizia	VP106	IND	✓	✓	✓
	Vizia	VPE04	IND	✓	✓	✓
Lutron	Centurion	C-600	IND	✓	✓	✓
	Decora	HCM06-1DW	IND/MLV	✓	✓	✓
	Diva	DV-10P	IND	✓		
	Diva	DV-600P	IND	✓		
	Diva	DVELV-300P	ELV	✓	✓	✓
	Diva	DVF-103P	FLR	✓	✓	✓
	Diva	DVLV-600P	MLV	✓		
	Diva	DVWCL-153DH	CFL/LED	✓	✓	✓
	Faetra	FAELV-500	ELV	✓	✓	✓
	Lyneo	LX-600PL	IND	✓	✓	✓
	Maestro	MA-1000	IND	✓	✓	✓
	Maestro	MAELV-600	MLV	✓	✓	✓
	Nova	NLV-1503P	MLV	✓	✓	✓
	Nova T	NT-603P	IND	✓	✓	✓
	Nova T	NTELV-600	ELV	✓	✓	✓
	RadioRA2	RRD-6NA	IND/ELV/HAL/MLV	✓	✓	✓
	RadioRA2	RRD-10ND	IND/HAL/MLV	✓	✓	✓
	Skylark	S-600	IND	✓		
	Skylark	SF-10P	FLR	✓		
	Skylark	SELV-300P	ELV	✓	✓	✓
Skylark	SLV-600P	MLV	✓			
Sureslide	6673-P	CFL	✓	✓	✓	
Toggler	TG-600PR-W4	IND/MLV	✓	✓	✓	

Manufacturer	Model/Series	Part Number	Type	Compatible with 1 LMH2	Compatible with 2 LMH2s	Compatible with 3 LMH2s
Pass and Seymour		90680-W	IND	✓	✓	✓
		LS600	IND	✓	✓	✓
Wattstopper		MCD267-W	UNI	✓	✓	✓

CFL = Compact fluorescent dimmer
 ELV = Electronic low-voltage dimmer
 FLR = Fluorescent dimmer
 HAL = Halogen dimmer

IND = Incandescent dimmer
 LED = Light-emitting diode dimmer
 MLV = Magnetic low-voltage dimmer
 UNI = Universal dimmer

The presence of a dimmer in the above table is not a guarantee or warranty of the compatibility of the LMH2 product family in any particular installation. The absence of a dimmer from the tables does not necessarily imply incompatibility. Please refer to the dimmer manufacturer's instructions for installation and further product information.

120-VAC Dimmer Compatibility with Sunset Dimming

Manufacturer	Model/Series	Part Number	Type	Compatible with 1 LMH2	Compatible with 2 LMH2s	Compatible with 3 LMH2s
Leviton	Illumatech	IPE04-1LX	ELV	✓	✓	✓
Lutron	Diva	DVELV-300P	ELV	✓	✓	✓
	Faedra	FAELV-500	ELV	✓	✓	✓
	Maestro	MAELV-600	MLV	✓	✓	✓
	Nova T	NTELV-600	ELV	✓	✓	✓
	Skylark	SELV-300P	ELV	✓	✓	✓

ELV = Electronic low-voltage dimmer

MLV = Magnetic low-voltage dimmer

The presence of a dimmer in the above table is not a guarantee or warranty of the compatibility of the LMH2 product family in any particular installation. The absence of a dimmer from the tables does not necessarily imply incompatibility. Please refer to the dimmer manufacturer's instructions for installation and further product information.

230-VAC Dimmer Compatibility with WhiteLight Dimming

Manufacturer	Model/Series	Part Number	Type	Compatible with 1 LMH2	Compatible with 2 LMH2s
100 Million Beautiful Elec.	None	None	Leading edge	✓	✓
Berker	Drehdimmer	2830 10	Leading edge	✓	✓
Busch-Jaeger	2247 U	6512-0-0057	Leading edge	✓	✓
	2250 U	6515-0-0704	Leading edge	✓	✓
	6513 U-102	6513-0-0568	Trailing edge	✓	✓
	6517 U-101	6517-0-0016	Leading edge	✓	✓
Clipsal	E30 System	32E450LM	Leading edge	✓	✓
	E2000	E2031LPD600	Leading edge	✓	✓
	E30 System	E32V500/2K	Leading edge	✓	✓
	Vivace	KB31RD400	Leading edge	✓	✓

Manufacturer	Model/Series	Part Number	Type	Compatible with 1 LMH2	Compatible with 2 LMH2s
Feller	Drehdimmer	40383.BSE	Leading edge	✓	✓
	Drehdimmer	40600.RLC.BSE	UNI	✓	✓
	Drehdimmer	40683.BSE	Leading edge	✓	✓
Flexalite	None	FD630D	Leading edge	✓	✓
Fung Yip Electrical	IEC 60669-2-1	PT15625-2871	Leading edge	✓	✓
Futina	D1	None	Leading edge	✓	✓
Gira	Glühlampen	0302 00 / I01	Leading edge	✓	✓
	System 2000	0305 00 / I04	UNI	✓	✓
	Glühlampen	0306 00 / I00	Leading edge	✓	✓
	Tronic	0307 00 / I02	Trailing edge	✓	✓
	Glühlampen	1181 00 / I02	Leading edge	✓	✓
	Niedervolt	2262 00 / I00	Leading edge	✓	✓
HPM	400T	050411/2/1A	Trailing edge	✓	✓
Jung	Glühlampen	211 GDE	Leading edge	✓	✓
Key-Top	None	AL-18	Leading edge	✓	✓
	None	BP-81	Leading edge	✓	✓
KI	None	None	Leading edge	✓	✓
Legrand	Arteor	5740 08	UNI	✓	✓
	Arteor	5743 08	UNI	✓	✓
	PRO 21	7756 37	UNI	✓	✓
	PRO 21	7759 03	Trailing edge	✓	✓
Leviton	Trimatron	012-6602-220	Leading edge	✓	✓
	Excella	K52-BLE04-2LW	Trailing edge	✓	✓
	Manhattan	K02-BME04-2LW	Trailing edge	✓	✓
Lutron	Lyneo	LLSM-502	Leading edge	✓	✓
Mank	None	None	Leading edge	✓	✓
PDL	600	634M	Leading edge	✓	✓
Siemens	Glühlampen	5TC8 256	Leading edge	✓	✓
	µ-Contact	5TGO752-1NC1	Leading edge	✓	✓
Super	None	BP-600	Leading edge	✓	✓

The presence of a dimmer in the above tables is not a guarantee or warranty of the compatibility of the LMH2 product family in any particular installation. The absence of a dimmer from the tables does not necessarily imply incompatibility. Please refer to the dimmer manufacturer's instructions for installation and further product information.

MECHANICAL DIMENSIONS

Physical Characteristics of the LMD125

Physical Characteristic	LMD125 100- to 120-V and 277-V Driver	LMD125 230-V Driver
Weight (g)	114	146
Maximum height (mm)	29.5	33
Maximum length (mm)	81	123
Maximum width (mm)	56	79

LMD125 100- to 120-V and 277-V Drivers¹

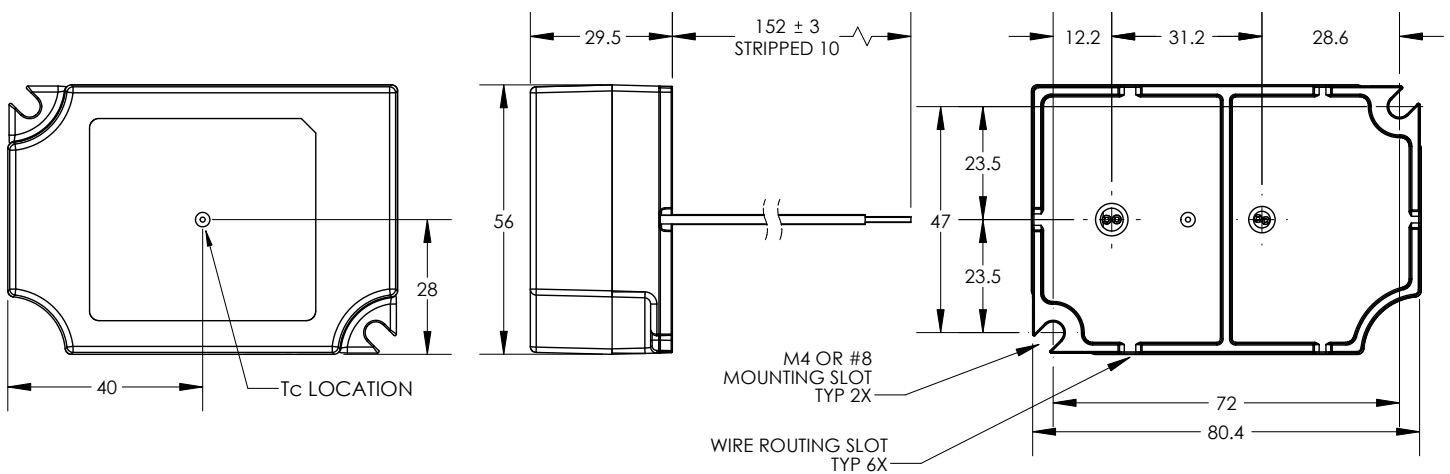

LMD125 230-V Driver

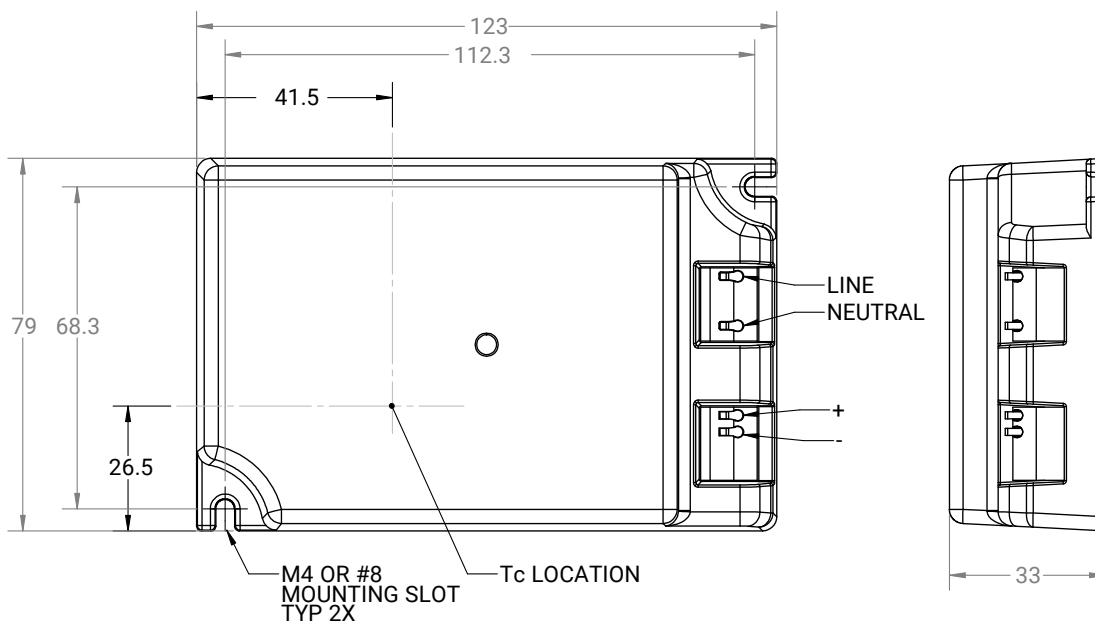

¹ Dimensions for all the LMD125 diagrams are in mm and are for reference only. For exact dimensions and tolerances, refer to the 3-D models (.STEP files) for the LMD125 drivers available by selecting the Documentation tab on the [LMH2 product page](#).

WIRING DIAGRAMS

The unique design of the LMD125 LED module driver allows it to be mounted on an internal surface or to a junction box cover. For the 100- to 120-V and 277-V drivers, the leads can be routed through holes in a junction box cover and accessed in a standard junction box. When surface mounted, the LMD125 driver leads can be routed through the various wiring slots on each side.

Electrical Connection

For the LMD125 100- to 120-V and 277-V LED module drivers, LMH2 LED module operation is accomplished by connecting the AC mains to the two (2) lead wires (line and neutral) from the driver and connecting the driver output wires to the input leads on the Cree LMH2 light source, as indicated in the following wiring diagrams. For the LMD125 230-V LED module driver, module operation is accomplished by connecting the AC mains to the appropriate terminal block pins.

The LMD125 100- to 120-V and LMD125 277-V LED module driver lead wires are 152.4 mm long, 18 AWG with the ends stripped 10 mm. The LMD125 230-V LED module drivers have poke-in terminals.

LMD125 100- to 120-V and 277-V Drivers

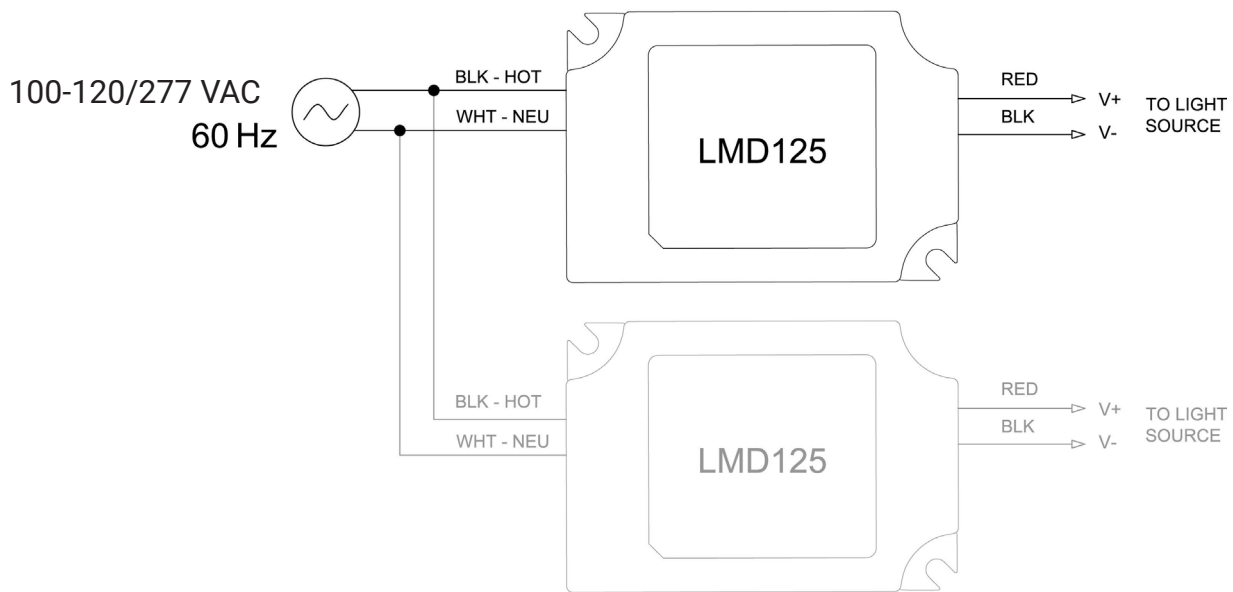

LMD125 230-V Driver

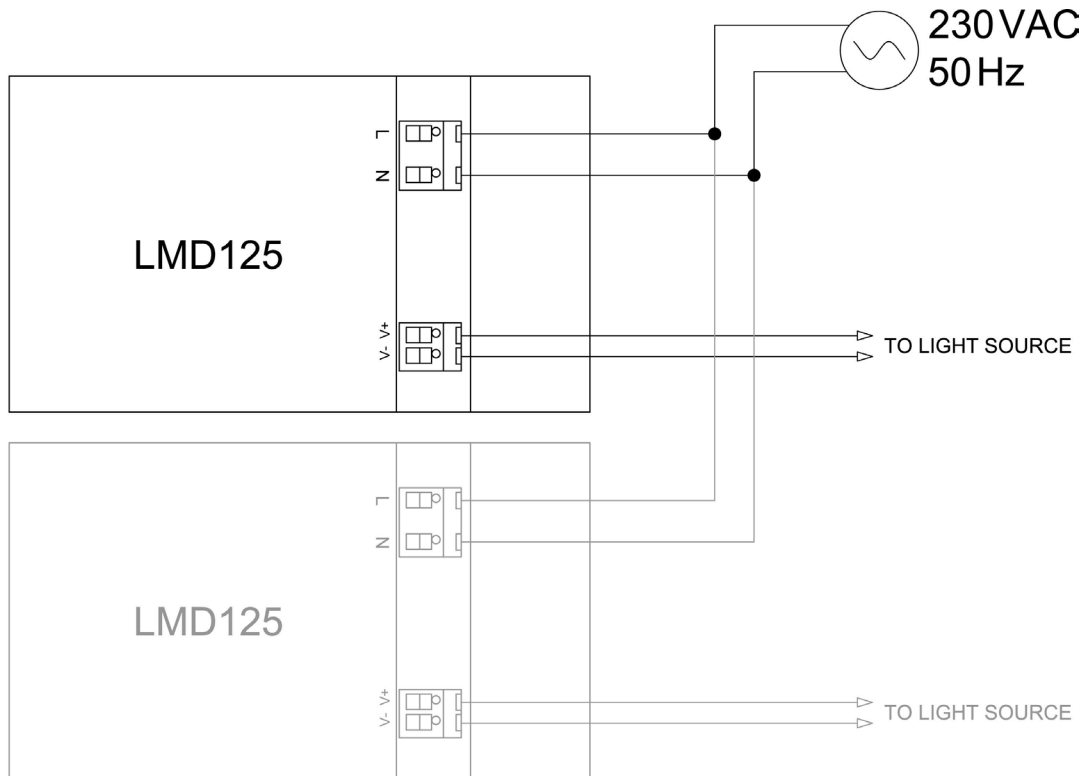

MULTIPLE UNITS MAY BE DAISYCHAINED

Wiring Strain Relief

LMD125 LED module drivers must not be suspended directly by the leads. Though the wiring from the LMD125 LED module driver is internally strain relieved, additional strain relief methods must be employed if the luminaire is to be suspended solely by the wiring, as in a pendant luminaire.

THERMAL DESIGN

Expected LMD125 Lifetime versus Temperature at Tc Point

Expected Operation Life (Hours)	Tc (°C) @ 25 °C Room Ambient	
	LMD125 100- to 120-V and 277-V Driver	LMD125 230-V Driver
35,000	73	74
50,000	67	68

EMERGENCY BATTERY OPERATION

The LMD125 LED module drivers are constant-current supplies. Interrupting the driver current with a battery supply is an acceptable method of emergency or power outage operation. An acceptable installation should also include a switching mechanism that prevents the battery power from entering the driver through the DC output leads. Confirming backup power supply compatibility is the responsibility of the luminaire manufacturer or installer. Please refer to the backup power supply manufacturer’s instructions for installation and further product information.

SAFETY AND REGULATORY NOTES

The following tables show the safety and regulatory certifications for the LMD125 LED module drivers.

	LMD125 100 to 120 VAC TRIAC Dimming 50/60-Hz Driver		LMD125 277 VAC Non-dimming 60-Hz Driver	
	Standard	File Number	Standard	File Number
Safety	J61347-1 (H20)	CJP2012109004-0645		
	J61347-1 (H21)			
	UL/cUL recognized (UL8750)	E520046	UL/cUL recognized (UL8750)	E520046
	Class 2 power supply		Class 2 power supply	
	UL – Damp rated		UL – Damp rated	
	5VA flame rating		5VA flame rating	
Electromagnetic compatibility	FCC 47 CFR Part 15, Subpart B, Class B and Industry Canada ICES-003, Class B	R11CA40667-FCC	FCC 47 CFR Part 15, Subpart B, Class B and Industry Canada ICES-003, Class A	R11CA41176-FCC
Regulatory	IEEE C.62.41-1991 Class A (surge)		IEEE C.62.41-1991 Class A (surge)	
	NEMA 410		NEMA 410	
Environmental	RoHS		RoHS	

	LMD125 230 VAC TRIAC dimming 50/60-Hz Driver	
	Standard	File Number
Safety	EN 61347-1	RZCE2011-0452LVD
	EN 61347-2-13	
	CE SELV equivalent	
	IP-20	6JW2012-1878
	IEC 62384	
	CQC	
Electromagnetic compatibility	EN 55015	RZCE2011-0452EMC
	IEC 61000-3-2	
	IEC 61000-3-3	
	IEC 61547	
Environmental	RoHS	

Safety Certification

Together, the LMH2 light source combined with the LMD125 LED module driver is “suitable for damp locations; covered ceilings.” Final luminaire designs should go through safety certification as required, which is the responsibility of the luminaire manufacturer.

PACKAGING

LMD125 100- to 120-V and 277-V LED module drivers are each packaged in boxes of 10, which are then combined in cartons of 10 boxes, or 100 LMD125 100- to 120-V or 277-V drivers.

LMD125 230-V LED module drivers are packaged in boxes of 10, which are then combined in cartons of 12 boxes, or 120 LMD125 230-V drivers.

Box and carton sizes are as follows.

Box of 10 LMD125 100- to 120-V or 277-V LED module drivers: 274 x 134 x 92 mm

Carton of 10 LMD125 100- to 120-V or 277-V driver boxes: 563 x 480 x 167 mm

Box of 10 LMD125 230-V LED module drivers: 215 x 176 x 133 mm

Carton of 12 LMD125 230-V driver boxes: 556 x 456 x 302 mm