



1500 Watt Low Clamping Factor Transient Voltage Suppressor

Screening in
reference to
MIL-PRF-19500
available

DESCRIPTION

This Transient Voltage Suppressor (TVS) series for 1N6358 through 1N6372 are JEDEC registered selections for both unidirectional and bidirectional devices. The 1N6358 through 1N6364 are unidirectional and the 1N6366 through 1N6372 are bidirectional where they all provide a very low specified clamping factor for minimal clamping voltages (V_C) above their respective breakdown voltages (V_{BR}) as specified herein. They are most often used in protecting sensitive components from inductive switching transients or induced secondary lightning effects as found in lower surge levels of IEC61000-4-5. They are also very successful in protecting airborne avionics and electrical systems. Since their response time is virtually instantaneous, they can also protect from ESD and EFT per IEC61000-4-2 and IEC61000-4-4.

Important: For the latest information, visit our website <http://www.microsemi.com>.

FEATURES

- Unidirectional and bidirectional TVS series in axial package for thru-hole mounting.
- Suppresses transients up to 1500 watts @ 10/1000 μ s (see [figure 1](#)).
- $t_{clamping}$ (0 volts to $V_{(BR)}$ min):
Unidirectional – Less than 100 picoseconds.
Bidirectional – Less than 5 nanoseconds.
- Working voltage (V_{WM}) range 10 V to 45 V.
- Low clamping factor (ratio of actual V_C/V_{BR}): 1.33 @ full rated power and 1.20 @ 50% rated power.
- Hermetically sealed DO-13 metal package.
- Upscreening in reference to MIL-PRF-19500 is available.
- RoHS compliant versions available.

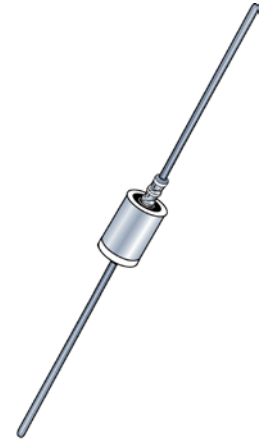
APPLICATIONS / BENEFITS

- Designed to protect bipolar and MOS microprocessor based systems
- Protection from switching transients and induced RF.
- Protection from ESD & EFT per IEC 61000-4-2 and IEC 61000-4-4.
- Secondary lightning protection per IEC61000-4-5 with 42 ohms source impedance:
Class 1, 2 & 3: 1N6358 to 1N6372
Class 4: 1N6358 to 1N6362 and 1N6366 to 1N6370
- Secondary lightning protection per IEC61000-4-5 with 12 ohms source impedance:
Class 1 & 2: 1N6358 to 1N6372
Class 3: 1N6358 to 1N6362 and 1N6366 to 1N6370
Class 4: 1N6358 and 1N6366
- Secondary lightning protection per IEC61000-4-5 with 2 ohms source impedance:
Class 2: 1N6358 to 1N6361 and 1N6366 to 1N6369
Class 3: 1N6358 and 1N6366
- Inherently radiation hard as described in Microsemi "[MicroNote 050](#)".

MAXIMUM RATINGS

Parameters/Test Conditions	Symbol	Value	Unit
Junction and Storage Temperature	T_J and T_{STG}	-65 to +175	$^{\circ}$ C
Thermal Resistance, Junction to Lead @ 0.375 inch (10 mm) from body	$R_{\theta JL}$	50	$^{\circ}$ C/W
Thermal Resistance, Junction to Ambient ⁽¹⁾	$R_{\theta JA}$	110	$^{\circ}$ C/W
Peak Pulse Power @ $T_L = +25$ $^{\circ}$ C ⁽²⁾	P_{PP}	1500	W
Rated Average Power Dissipation @ $T_L \leq +125$ $^{\circ}$ C ⁽³⁾	$P_{M(AV)}$	1	W
Solder Temperature @ 10 s	T_{SP}	260	$^{\circ}$ C

- Notes:**
1. When mounted on FR4 PC board with 4 mm² copper pads (1 oz) and track width 1 mm, length 25 mm.
 2. At 10/1000 μ s with repetition rate of 0.01% or less (see [figures 1, 2, & 4](#)).
 3. At 3/8 inch (10 mm) from body (see derating in [figure 5](#)). TVS devices are not typically used for dc power dissipation and are instead operated at or less than their rated standoff voltage (V_{WM}) except for transients that briefly drive the device into avalanche breakdown (V_{BR} to V_C region).



DO-13 (DO-202AA)
Package

MSC – Lawrence

6 Lake Street,
Lawrence, MA 01841
Tel: 1-800-446-1158 or
(978) 620-2600
Fax: (978) 689-0803

MSC – Ireland

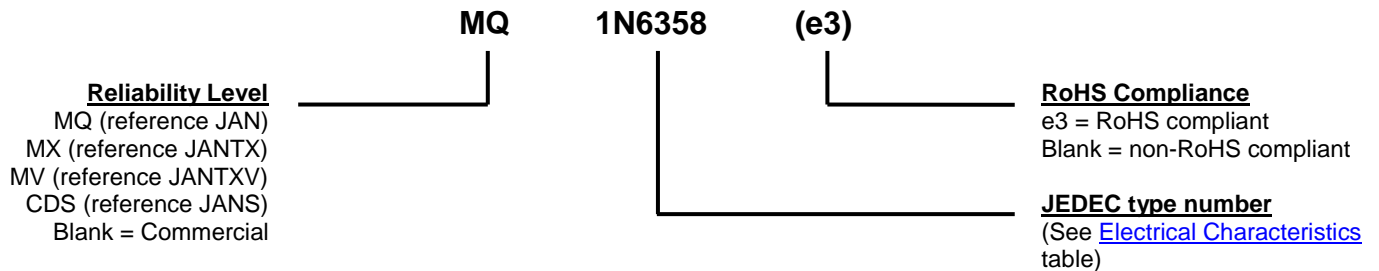
Gort Road Business Park,
Ennis, Co. Clare, Ireland
Tel: +353 (0) 65 6840044
Fax: +353 (0) 65 6822298

Website:

www.microsemi.com

MECHANICAL and PACKAGING

- CASE: DO-13 (DO-202AA), welded, hermetically sealed metal and glass.
- TERMINALS: All external metal surfaces are tin-lead plated or RoHS compliant annealed matte-tin plating solderable per MIL-STD-750 method 2026.
- MARKING: Part number and polarity diode symbol.
- POLARITY: Cathode connected to case and polarity indicated by diode symbol.
- TAPE & REEL option: Standard per EIA-296 (add "TR" suffix to part number). Consult factory for quantities.
- WEIGHT: Approximately 1.4 grams.
- See [package dimensions](#) on last page.

PART NOMENCLATURE

SYMBOLS & DEFINITIONS

Symbol	Definition
V_{WM}	Standoff Voltage: Applied Reverse Voltage to assure a nonconductive condition.
$V_{(BR)}$	Breakdown Voltage: This is the Breakdown Voltage the device will exhibit at 25 °C.
V_C	Maximum Clamping Voltage: The maximum peak voltage appearing across the TVS when subjected to the peak pulse current in a one millisecond time interval. The peak pulse voltage is the combination of voltage rise due to both the series resistance and thermal rise and positive temperature coefficient ($\alpha_{V(BR)}$).
I_{PP}	Peak Pulse Current: The peak current during the impulse. (See figure 2)
P_{PP}	Peak Pulse Power: The pulse power as determined by the product of V_C and I_{PP} .
I_D	Standby Current: The current at the standoff voltage (V_{WM}).

ELECTRICAL CHARACTERISTICS @ 25 °C (Both Polarities)
Unidirectional

MICROSEMI PART NUMBER		STANDOFF VOLTAGE (NOTE 1) V_{WM} Volts	MAXIMUM REVERSE LEAKAGE @ V_{WM} I_D μA	MINIMUM* BREAKDOWN VOLTAGE @ 1.0 mA $V_{(BR)}$ (min) Volts	MAXIMUM CLAMPING VOLTAGE (Fig. 2) $I_{PP1} = 1A$ V_C Volts	MAXIMUM CLAMPING VOLTAGE (Fig. 2) @ $I_{PP2} = 10A$ V_C Volts	MAXIMUM PEAK PULSE CURRENT I_{PP3} A
1N6358	MPT-10	10.0	2	11.7	13.7	14.1	90
1N6359	MPT-12	12.0	2	14.1	16.1	16.5	70
1N6360	MPT-15	15.0	2	17.6	20.1	20.6	60
1N6361	MPT-18	18.0	2	21.2	24.2	25.2	50
1N6362	MPT-22	22.0	2	25.9	29.8	32.0	40
1N6363	MPT-36	36.0	2	42.4	50.6	54.3	23
1N6364	MPT-45	45.0	2	52.9	63.3	70.0	19

V_F at 100 amps peak is 3.5 volts maximum at 8.3 ms half-sine wave.

Bidirectional

MICROSEMI PART NUMBER		STANDOFF VOLTAGE (NOTE 1) V_{WM} Volts	MAXIMUM REVERSE LEAKAGE @ V_{WM} I_D μA	MINIMUM* BREAKDOWN VOLTAGE @ 1.0 mA $V_{(BR)}$ (min) Volts	MAXIMUM CLAMPING VOLTAGE (Fig. 2) $I_{PP1} = 1A$ V_C Volts	MAXIMUM CLAMPING VOLTAGE (Fig. 2) @ $I_{PP2} = 10A$ V_C Volts	MAXIMUM PEAK PULSE CURRENT I_{PP3} A
1N6366	MPT-10C	10.0	2	11.7	14.1	14.5	90
1N6367	MPT-12C	12.0	2	14.1	16.7	17.1	70
1N6368	MPT-15C	15.0	2	17.6	20.8	21.4	60
1N6369	MPT-18C	18.0	2	21.2	24.8	25.5	50
1N6370	MPT-22C	22.0	2	25.9	30.8	32.0	40
1N6371	MPT-36C	36.0	2	42.4	50.6	54.3	23
1N6372	MPT-45C	45.0	2	52.9	63.3	70.0	19

"C" suffix indicates bidirectional

NOTE 1: TVS devices are normally selected according to the reverse "standoff voltage" (V_{WM}) which should be equal to or greater than the DC or continuous peak operating voltage level.

* The minimum breakdown voltage as shown takes into consideration the \pm volt tolerance normally specified for power supply regulation on most integrated circuit manufacturers data sheets. Similar devices are available with reduced clamping voltages where tighter regulated power supply voltages are employed.

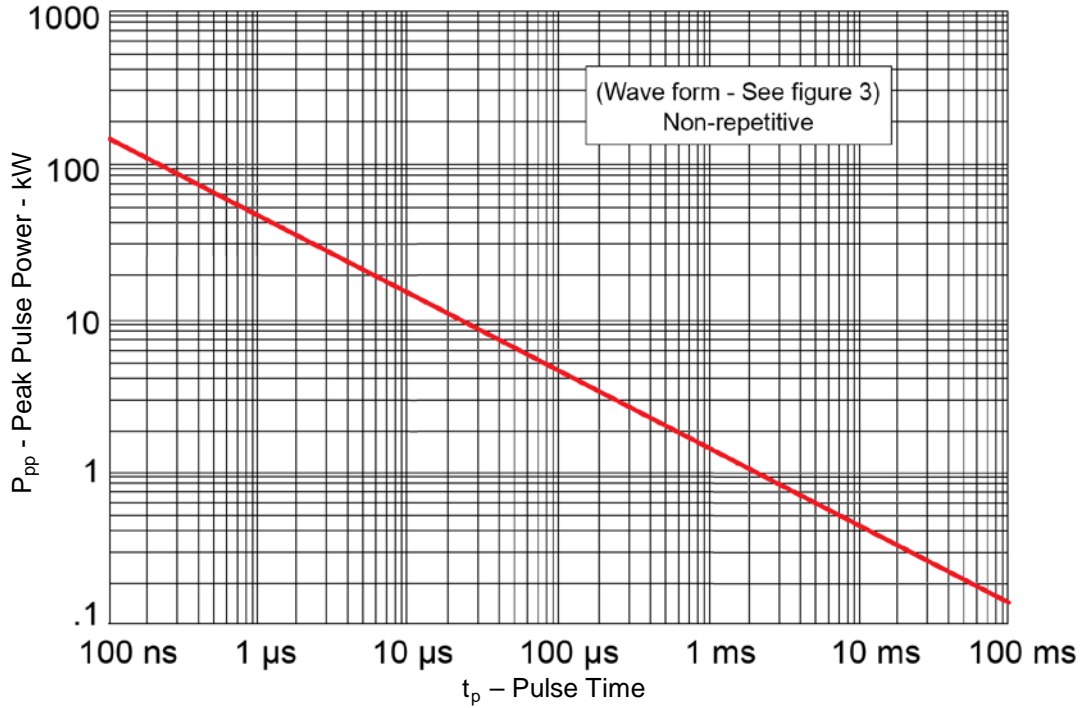
GRAPHS


FIGURE 1
Peak Pulse Power vs Pulse Time

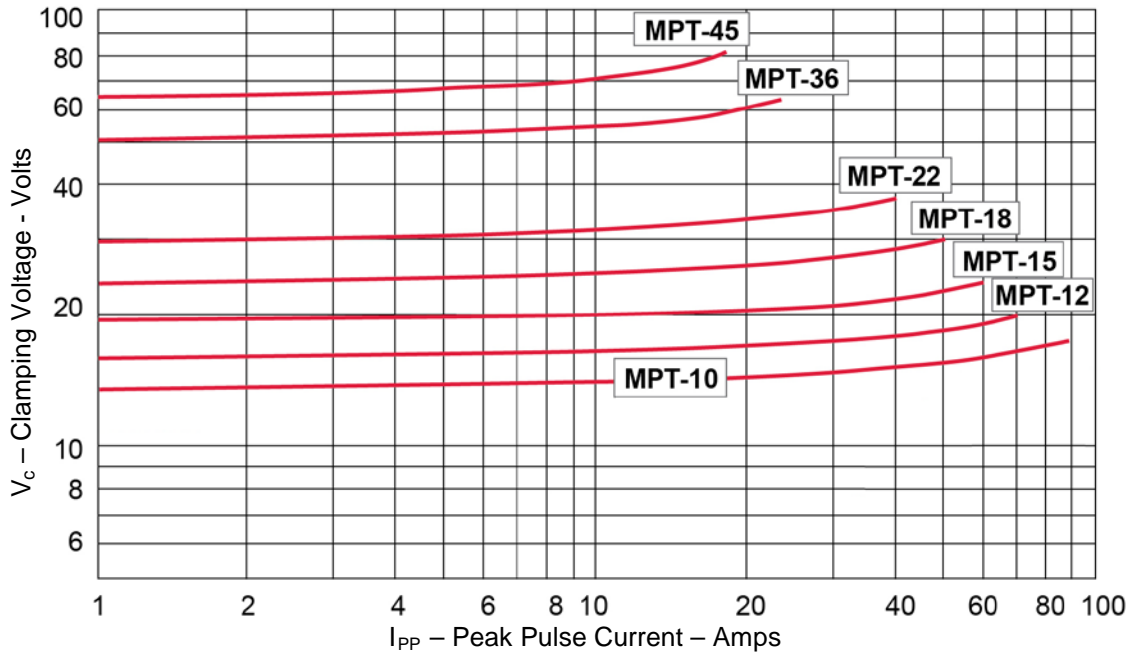


FIGURE 2
Typical Characteristic Clamping Voltage vs. Peak Pulse Current

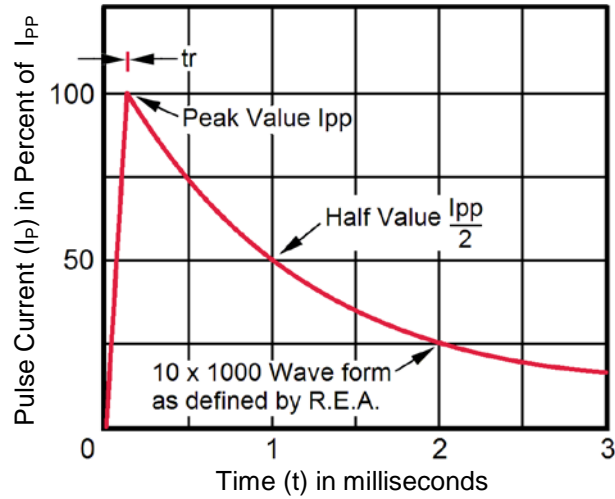
GRAPHS


FIGURE 3
Pulse Wave Form for Exponential Surge

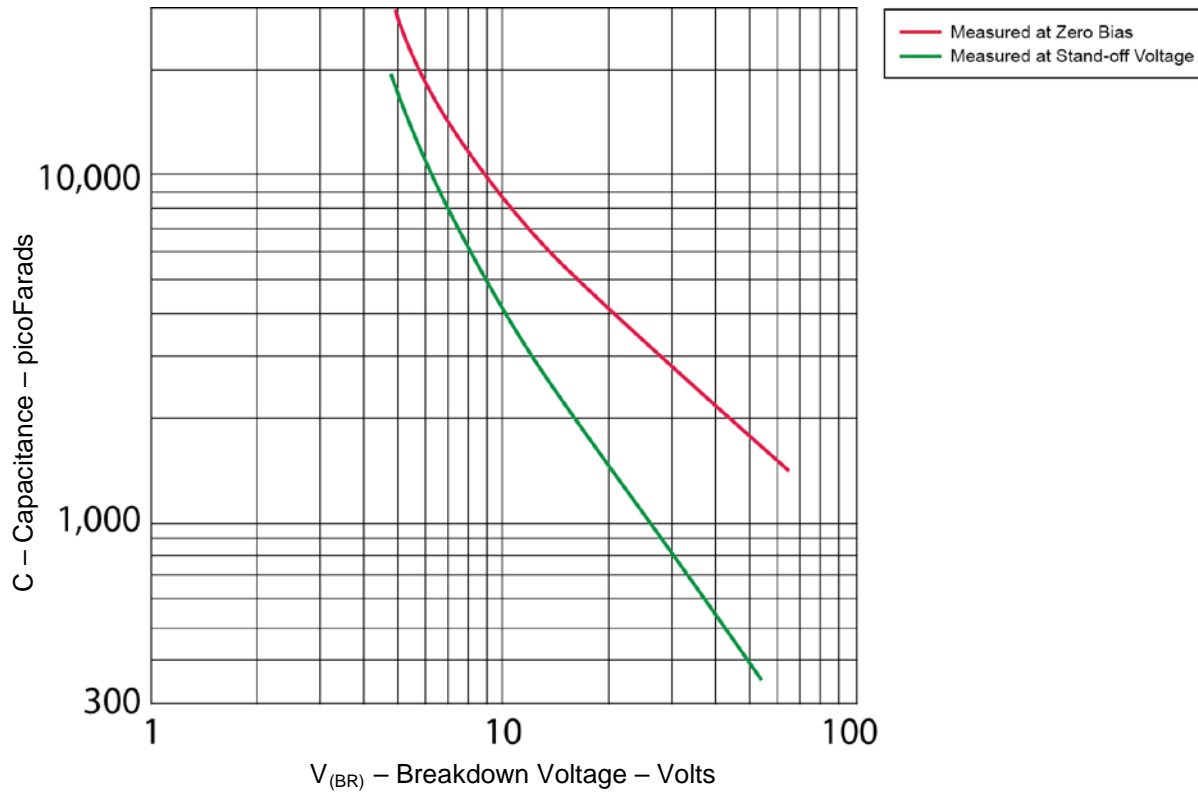


FIGURE 4
Typical Capacitance vs. Breakdown Voltage (Unidirectional Types)

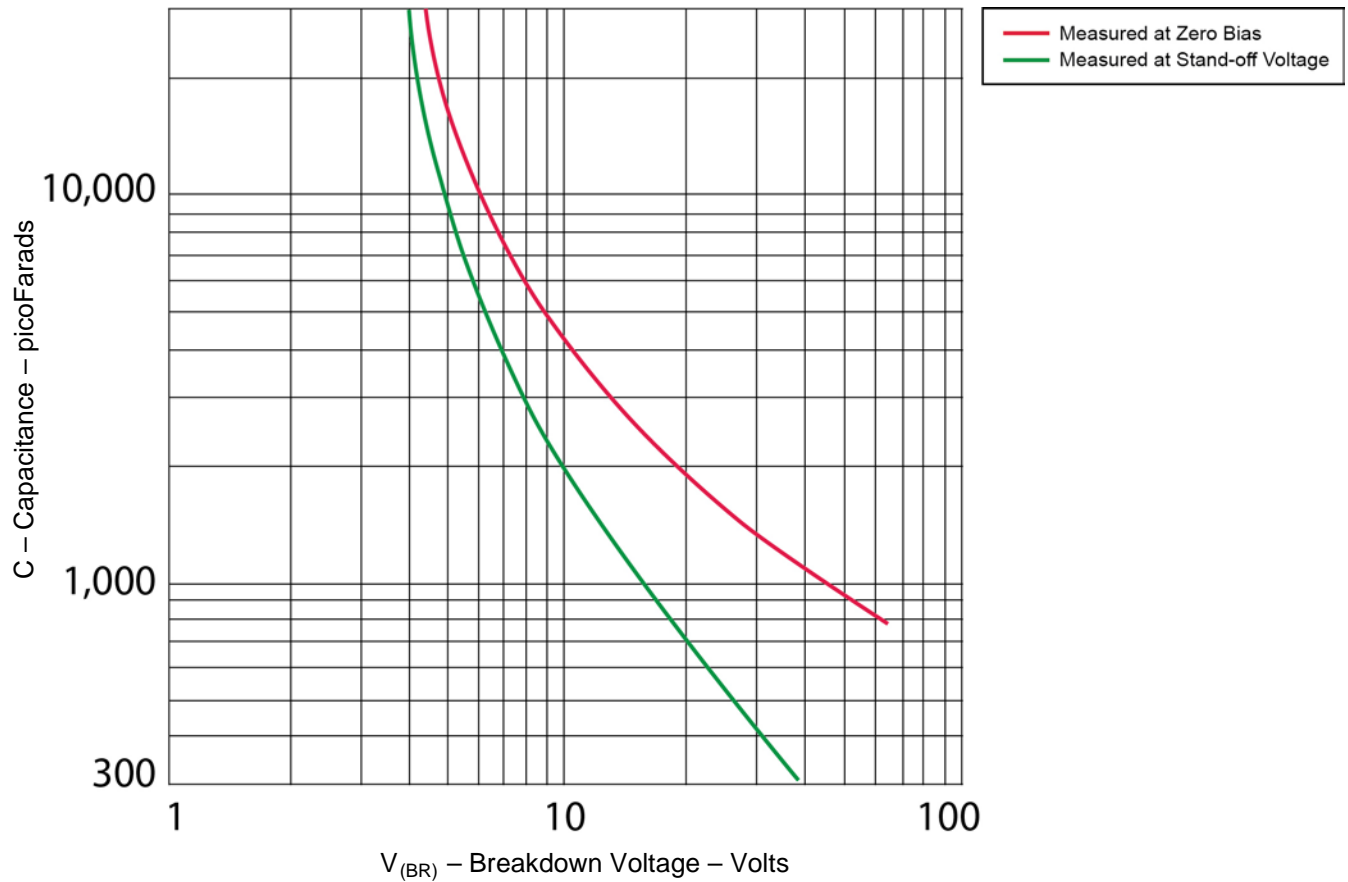
GRAPHS


FIGURE 5
Typical Capacitance vs. Breakdown Voltage (Bidirectional Types)

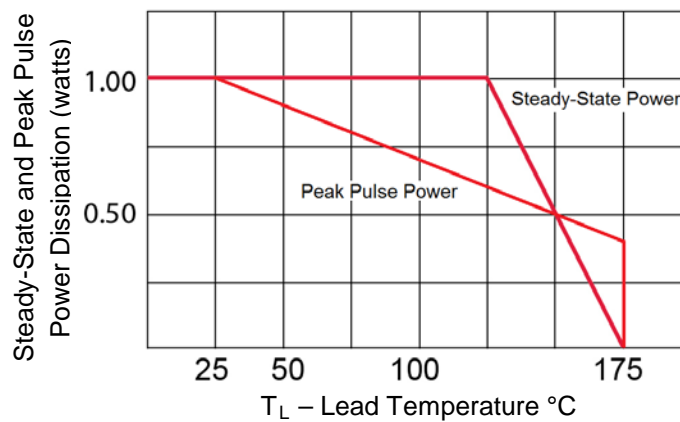
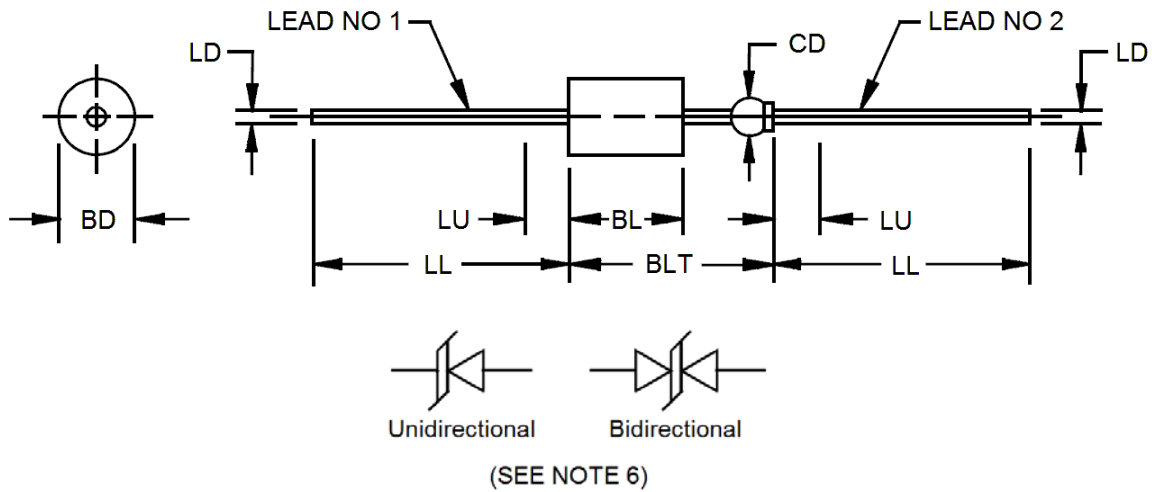


FIGURE 6
Steady-State and Peak Pulse Power Derating Curve

PACKAGE DIMENSIONS

NOTES:

1. Dimensions are in inches.
2. Millimeter equivalents are given for general information only.
3. The major diameter is essentially constant along its length.
4. Within this zone, diameter may vary to allow for lead finishes and irregularities.
5. Dimension to allow for pinch or seal deformation anywhere along tubulation.
6. Polarity symbol for transient suppressor.
7. Lead 1 shall be electrically connected to the case.
8. In accordance with ASME Y14.5M, diameters are equivalent to Φx symbology.

Symbol	Dimensions				Notes
	Inches		Millimeters		
	Min	Max	Min	Max	
BD	0.215	0.235	5.46	5.97	
BL	0.293	0.357	7.44	9.07	3
BLT	-	0.570	-	14.48	
CD	0.045	0.100	1.14	2.54	5
LD	0.025	0.035	0.64	0.89	
LL	1.000	1.625	25.40	41.28	
LU	-	0.188	-	4.78	4