

## Low Voltage Detector with Individual SENSE Pin and Delay Function

No. EA-242-201202

### OUTLINE

The R3118x is a voltage detector IC with individual sense pin, high detector threshold accuracy and delay time, and ultra-low supply current, which can be operated at an extremely low voltage and is used for system reset as an example. Each of the IC consists of a voltage reference unit, a hysteresis comparator, resistors net for detector threshold setting, an output driver transistor, and a delay circuit.

$V_{DD}$  supply pin for the IC and voltage supervisory sense pin are individual, therefore the output pin can keep "L" level even if the sense pin voltage is going down to 0 V, or there is no indefinite range for the sense pin.

Since a delay circuit is built-in, by connecting an external capacitor, any output delay time can be set. In the R3118x, detector released delay time can be set, and detector delay time is not influenced by the external capacitor for the delay time.

The detector threshold is fixed with high accuracy internally and does not require any adjustment. The tolerance of the detector threshold is  $\pm 22.5$  mV ( $-V_{DET\_S} < 1.6$  V) or  $\pm 1.5\%$  ( $-V_{DET\_S} \geq 1.6$  V).

Minimum detector threshold voltage is 0.6 V, ultra-low voltage detector threshold can be set. Output delay time for the detector release can be set with high accuracy. The tolerance of the IC side is  $\pm 30\%$ . Two output types, Nch. open drain type and CMOS type are available. If the sense pin voltage becomes to equal or lower than the detector threshold voltage, the output voltage becomes "L", and if the sense pin voltage becomes to released voltage, the output voltage becomes "H" after the set delay time.

Three types of packages, SOT-23-5, SC-88A, and DFN(PLP)1212-6 are available.

### FEATURES (1)

- Operating Voltage Range (Maximum Rating) ..... 1.0 V to 6.0 V (7.0 V)
- Supply Current<sup>(2)</sup> ..... Typ. 0.4  $\mu$ A ( $V_{SENSE} \geq +V_{DET}$ ,  $V_{DD} = 6$  V)
- Operating Temperature Range .....  $-40^{\circ}\text{C}$  to  $85^{\circ}\text{C}$
- Detector Threshold Range ..... 0.6 V to 5.0 V (0.1 V step)
- Accuracy Detector Threshold .....  $\pm 1.5\%$  ( $-V_{DET\_S} \geq 1.6$  V),  $\pm 22.5$  mV ( $-V_{DET\_S} < 1.6$  V)
- Temperature-Drift Coefficient of Detector Threshold · Typ.  $\pm 30$  ppm/ $^{\circ}\text{C}$
- Accuracy Detector Released .....  $\pm 30\%$
- Temperature-Drift Coefficient of Detector Released · Typ.  $\pm 0.16$  ppm/ $^{\circ}\text{C}$
- Output Types ..... Nch Open Drain and CMOS
- Packages ..... DFN(PLP)1212-6, SC-88A, SOT-23-5

### APPLICATIONS

- CPU and Logic Circuit Reset
- Battery Checker
- Window Comparator/Level Discrimination
- Battery Back-up Circuit
- Power Failure Detector

<sup>(1)</sup>  $T_a = 25^{\circ}\text{C}$ , unless otherwise specified.

<sup>(2)</sup> Consumption current through SENSE pin is not included.

---

**R3118x**

---

No. EA-242-201202

**SELECTION GUIDE**

The detector threshold, the output type and the package type for the IC can be selected at the users' request.

**Selection Guide**

Product Name	Package	Quantity per Reel	Pb Free	Halogen Free
R3118Kxx1*-TR	DFN(PLP)1212-6	5,000 pcs	Yes	Yes
R3118Qxx2*-TR-FE	SC-88A	3,000 pcs	Yes	Yes
R3118Nxx1*-TR-FE	SOT-23-5	3,000 pcs	Yes	Yes

xx: The detector threshold can be designated in the range from 0.6 V (06) to 5.0 V (50) in 0.1 V step.

\* : Designation of Output Type  
(A) Nch Open Drain  
(C) CMOS

---

**BLOCK DIAGRAMS**

**R3118xxxxA (Nch. Open Drain Output)  
Block Diagram**



**R3118xxxxC (CMOS Output)  
Block Diagram**

## PIN DESCRIPTIONS

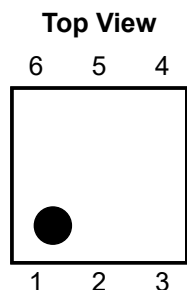

DFN(PLP)1212-6 Pin Configuration

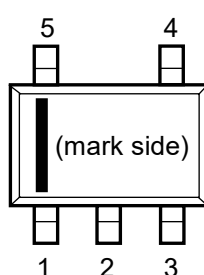
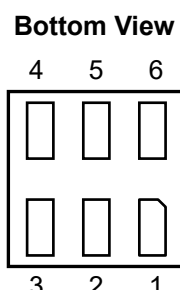

SC-88A Pin Configuration

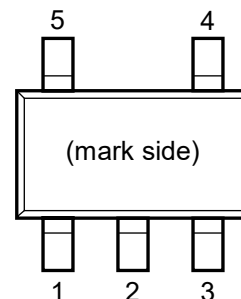

SOT-23-5 Pin Configuration

### DFN(PLP)1212-6 Pin Description

Pin No.	Symbol	Description
1	SENSE	Voltage Detector Voltage Sense Pin
2	GND	Ground Pin
3	CD	Pin for External Capacitor (for setting output delay)
4	VDD	Input Pin
5	NC	No Connection
6	DOUT	Output Pin ("L" at detection)

### SC-88A Pin Description

Pin No.	Symbol	Description
1	DOUT	Output Pin ("L" at detection)
2	GND	Ground Pin
3	VDD	Input Pin
4	CD	Pin for External Capacitor (for setting output delay)
5	SENSE	Voltage Detector Voltage Sense Pin

### SOT-23-5 Pin Description

Pin No.	Symbol	Description
1	DOUT	Output Pin ("L" at detection)
2	VDD	Input Pin
3	GND	Ground Pin
4	CD	Pin for External Capacitor (for setting output delay)
5	SENSE	Voltage Detector Voltage Sense Pin

## ABSOLUTE MAXIMUM RATINGS

### Absolute Maximum Ratings

Symbol	Item		Rating	Unit	
$V_{DD}$	Supply Voltage		-0.3 to 7.0	V	
$V_{SENSE}$	SENSE Pin Voltage		-0.3 to 7.0	V	
$V_{DOUT}$	Output Voltage (R3118xxxxA)		-0.3 to 7.0	V	
	Output Voltage (R3118xxxxC)		-0.3 to $V_{DD} + 0.3$		
$I_{DOUT}$	Output Current Nch Driver (Sink Current)		20	mA	
	Output Current Pch Driver (Source Current)		-5		
$P_D$	Power Dissipation <sup>(1)</sup>	DFN(PLP)1212-6	JEDEC STD.51-7 Test Land Pattern	450	mW
		SC-88A	Standard Test Land Pattern	380	
		SOT-23-5	JEDEC STD.51-7 Test Land Pattern	660	
$T_j$	Junction Temperature Range		-40 to 125	°C	
$T_{stg}$	Storage Temperature Range		-55 to 125	°C	

### ABSOLUTE MAXIMUM RATINGS

Electronic and mechanical stress momentarily exceeded absolute maximum ratings may cause permanent damage and may degrade the lifetime and safety for both device and system using the device in the field. The functional operation at or over these absolute maximum ratings is not assured.

## RECOMMENDED OPERATING CONDITIONS

### Recommended Operating Conditions

Symbol	Item	Rating	Unit
$V_{DD}$	Supply Voltage	1.0 to 6.0	V
$T_a$	Operating Temperature Range	-40 to 85	°C

### RECOMMENDED OPERATING CONDITIONS

All of electronic equipment should be designed that the mounted semiconductor devices operate within the recommended operating conditions. The semiconductor devices cannot operate normally over the recommended operating conditions, even if they are used over such conditions by momentary electronic noise or surge. And the semiconductor devices may receive serious damage when they continue to operate over the recommended operating conditions.

<sup>(1)</sup> Refer to *POWER DISSIPATION* for detailed information.

## ELECTRICAL CHARACTERISTICS

$V_{DD} = 1\text{ V to }6\text{ V}$ , unless otherwise specified.

The specifications surrounded by   are guaranteed by design engineering at  $-40^{\circ}\text{C} \leq T_a \leq 85^{\circ}\text{C}$ .

### R3118xxxxA/C Electrical Characteristics

( $T_a = 25^{\circ}\text{C}$ )

Symbol	Item	Conditions	Min.	Typ.	Max.	Unit	
$-V_{DET}$	Detector Threshold	$-V_{DET\_S}^{(1)} < 1.6\text{ V}$	$T_a = 25^{\circ}\text{C}$	$-V_{DET\_S}$ -0.0225	$-V_{DET\_S}$	$-V_{DET\_S}$ +0.0225	V
			$-40^{\circ}\text{C} \leq T_a \leq 85^{\circ}\text{C}$	<span style="border: 1px solid black; padding: 0 2px;"><math>-V_{DET\_S}</math> -0.0375</span>	$-V_{DET\_S}$	<span style="border: 1px solid black; padding: 0 2px;"><math>-V_{DET\_S}</math> +0.0375</span>	
		$-V_{DET\_S} \geq 1.6\text{ V}$	$T_a = 25^{\circ}\text{C}$	$-V_{DET\_S}$ $\times 0.985$	$-V_{DET\_S}$	$-V_{DET\_S}$ $\times 1.015$	
			$-40^{\circ}\text{C} \leq T_a \leq 85^{\circ}\text{C}$	<span style="border: 1px solid black; padding: 0 2px;"><math>-V_{DET\_S}</math> <math>\times 0.975</math></span>	$-V_{DET\_S}$	<span style="border: 1px solid black; padding: 0 2px;"><math>-V_{DET\_S}</math> <math>\times 1.025</math></span>	
$V_{HYS}$	Detector threshold Hysteresis	$T_a = 25^{\circ}\text{C}$	$-V_{DET\_S}$ $\times 0.040$	$-V_{DET\_S}$ $\times 0.055$	$-V_{DET\_S}$ $\times 0.070$	V	
		$-40^{\circ}\text{C} \leq T_a \leq 85^{\circ}\text{C}$	<span style="border: 1px solid black; padding: 0 2px;"><math>-V_{DET\_S}</math> <math>\times 0.035</math></span>	$-V_{DET\_S}$ $\times 0.055$	<span style="border: 1px solid black; padding: 0 2px;"><math>-V_{DET\_S}</math> <math>\times 0.075</math></span>		
$I_{SS}$	Supply Current <sup>(2)</sup>	$V_{SENSE} = 0\text{ V}, V_{DD} = 6\text{ V}$		0.480	<span style="border: 1px solid black; padding: 0 2px;">1.450</span>	$\mu\text{A}$	
		$V_{SENSE} = 6\text{ V}, V_{DD} = 6\text{ V}$		0.400	<span style="border: 1px solid black; padding: 0 2px;">1.200</span>		
$R_{SENSE}$	Sense Resistor	$V_{SENSE} = 6\text{ V}, V_{DD} = 6\text{ V}$	<span style="border: 1px solid black; padding: 0 2px;">9</span>	34	<span style="border: 1px solid black; padding: 0 2px;">58</span>	$\text{M}\Omega$	
$I_{DOUT}$	Output Current (Driver Output Pin)	Nch. $V_{SENSE} = 0\text{ V}$	$V_{DD} = 1\text{ V}, V_{DOUT} = 0.1\text{ V}$	<span style="border: 1px solid black; padding: 0 2px;">0.150</span>			mA
			$V_{DD} = 3\text{ V}, V_{DOUT} = 0.1\text{ V}$	<span style="border: 1px solid black; padding: 0 2px;">0.550</span>			
			$V_{DD} = 5\text{ V}, V_{DOUT} = 0.1\text{ V}$	<span style="border: 1px solid black; padding: 0 2px;">0.850</span>			
			$V_{DD} = 1\text{ V}, V_{DOUT} = 0.4\text{ V}$	<span style="border: 1px solid black; padding: 0 2px;">0.400</span>			
			$V_{DD} = 3\text{ V}, V_{DOUT} = 0.4\text{ V}$	<span style="border: 1px solid black; padding: 0 2px;">2.100</span>			
			$V_{DD} = 5\text{ V}, V_{DOUT} = 0.4\text{ V}$	<span style="border: 1px solid black; padding: 0 2px;">3.300</span>			
		Pch $V_{SENSE} = 6\text{ V}$ (R3118xxxxC)	$V_{DD} = 1\text{ V}, V_{DOUT} = 0.9\text{ V}$	<span style="border: 1px solid black; padding: 0 2px;">6</span>			$\mu\text{A}$
			$V_{DD} = 3\text{ V}, V_{DOUT} = 2.9\text{ V}$	<span style="border: 1px solid black; padding: 0 2px;">30</span>			
$V_{DD} = 5\text{ V}, V_{DOUT} = 4.9\text{ V}$	<span style="border: 1px solid black; padding: 0 2px;">45</span>						
$I_{LEAK}$	Nch Driver Leakage Current (R3118xxxxA)	$V_{SENSE} = 6\text{ V}, V_{DD} = 6\text{ V}, V_{DOUT} = 6\text{ V}$			<span style="border: 1px solid black; padding: 0 2px;">80</span>	nA	
$R_{DIS}$	CD pin Discharge Tr. On Resistance	$V_{SENSE} = 6\text{ V}, V_{DD} = 1\text{ V}, V_{CD} = 0.4\text{ V}$	<span style="border: 1px solid black; padding: 0 2px;">2.200</span>		<span style="border: 1px solid black; padding: 0 2px;">6.200</span>	k $\Omega$	
		$V_{SENSE} = 6\text{ V}, V_{DD} = 3\text{ V}, V_{CD} = 0.4\text{ V}$	<span style="border: 1px solid black; padding: 0 2px;">0.400</span>		<span style="border: 1px solid black; padding: 0 2px;">1.250</span>		
		$V_{SENSE} = 6\text{ V}, V_{DD} = 5\text{ V}, V_{CD} = 0.4\text{ V}$	<span style="border: 1px solid black; padding: 0 2px;">0.250</span>		<span style="border: 1px solid black; padding: 0 2px;">0.800</span>		

(1)  $-V_{DET\_S}$ : Set Detector Threshold

(2) Consumption current through SENSE pin is not included.

**ELECTRICAL CHARACTERISTICS (continued)**

$V_{DD} = 1\text{ V}$  to  $6\text{ V}$ , unless otherwise specified.

The specifications surrounded by   are guaranteed by design engineering at  $-40^{\circ}\text{C} \leq T_a \leq 85^{\circ}\text{C}$ .

**R3118xxxxA/C Electrical Characteristics****( $T_a = 25^{\circ}\text{C}$ )**

Symbol	Item	Conditions	Min.	Typ.	Max.	Unit
$t_{\text{RESET}}$	Detect Output Delay Time <sup>(1)</sup>	$T_a = 25^{\circ}\text{C}$		80		$\mu\text{s}$
$t_{\text{DELAY}}$	Release Output Delay Time <sup>(2)</sup>	$T_a = 25^{\circ}\text{C}$	70	100	130	ms
		$-40^{\circ}\text{C} \leq T_a \leq 85^{\circ}\text{C}$	<span style="border: 1px solid black; padding: 0 2px;">65</span>	100	<span style="border: 1px solid black; padding: 0 2px;">145</span>	

All of unit are tested and specified under load conditions such that  $T_j \approx T_a = 25^{\circ}\text{C}$  except for Detector Output Delay Time and Release Output Delay Time.

---

<sup>(1)</sup> **R3118xxxxC:** In the case that a  $0.022\ \mu\text{F}$  capacitor is connected to the CD pin, the time interval from forcing pulsive voltage between  $-V_{\text{DET\_S}} \times 1.155\text{ V}$  and  $-V_{\text{DET\_S}} \times 0.9\text{ V}$  to SENSE pin, to when the output voltage of the DOUT pin will reach from "H" to  $V_{\text{DD}}/2$ .

**R3118xxxxA:** In the case that a  $0.022\ \mu\text{F}$  capacitor is connected to the CD pin and the DOUT pin is pulled up to  $5\text{ V}$  with  $470\ \text{k}\Omega$ , the time interval from forcing pulsive voltage between  $-V_{\text{DET\_S}} \times 1.155\text{ V}$  and  $-V_{\text{DET\_S}} \times 0.9\text{ V}$  to SENSE pin, to when the output voltage reaches from "H" to  $2.5\text{ V}$ .

<sup>(2)</sup> **R3118xxxxC:** In the case that a  $0.022\ \mu\text{F}$  capacitor is connected to the CD pin, the time interval from forcing pulsive voltage between  $-V_{\text{DET\_S}} \times 0.9\text{ V}$  and  $-V_{\text{DET\_S}} \times 1.155\text{ V}$  to SENSE pin, to when the output voltage of the DOUT pin will reach from "L" to  $V_{\text{DD}}/2$ .

**R3118xxxxA:** In the case that a  $0.022\ \mu\text{F}$  capacitor is connected to the CD pin and the DOUT pin is pulled up to  $5\text{ V}$  with  $470\ \text{k}\Omega$ , the time interval from forcing pulsive voltage between  $-V_{\text{DET\_S}} \times 0.9\text{ V}$  and  $-V_{\text{DET\_S}} \times 1.155\text{ V}$  to SENSE pin, to when the output voltage reaches from "L" to  $2.5\text{ V}$ .

---

## ELECTRICAL CHARACTERISTICS (continued)

The specifications surrounded by   are guaranteed by design engineering at  $-40^{\circ}\text{C} \leq T_a \leq 85^{\circ}\text{C}$ .

### R3118xxxxA/C

Product Name	$-V_{\text{DET}} [\text{V}]$						$-V_{\text{HYS}} [\text{V}]$					
	$T_a = 25^{\circ}\text{C}$			$-40^{\circ}\text{C} \leq T_a \leq 85^{\circ}\text{C}$			$T_a = 25^{\circ}\text{C}$			$-40^{\circ}\text{C} \leq T_a \leq 85^{\circ}\text{C}$		
	Min.	Typ.	Max.	Min.	Typ.	Max.	Min.	Typ.	Max.	Min.	Typ.	Max.
R3118x06xx	0.5775	0.6000	0.6225	0.5625	0.6000	0.6375	0.0240	0.0330	0.0420	0.0210	0.0330	0.0450
R3118x07xx	0.6775	0.7000	0.7225	0.6625	0.7000	0.7375	0.0280	0.0385	0.0490	0.0245	0.0385	0.0525
R3118x08xx	0.7775	0.8000	0.8225	0.7625	0.8000	0.8375	0.0320	0.0440	0.0560	0.0280	0.0440	0.0600
R3118x09xx	0.8775	0.9000	0.9225	0.8625	0.9000	0.9375	0.0360	0.0495	0.0630	0.0315	0.0495	0.0675
R3118x10xx	0.9775	1.0000	1.0225	0.9625	1.0000	1.0375	0.0400	0.0550	0.0700	0.0350	0.0550	0.0750
R3118x11xx	1.0775	1.1000	1.1225	1.0625	1.1000	1.1375	0.0440	0.0605	0.0770	0.0385	0.0605	0.0825
R3118x12xx	1.1775	1.2000	1.2225	1.1625	1.2000	1.2375	0.0480	0.0660	0.0840	0.0420	0.0660	0.0900
R3118x13xx	1.2775	1.3000	1.3225	1.2625	1.3000	1.3375	0.0520	0.0715	0.0910	0.0455	0.0715	0.0975
R3118x14xx	1.3775	1.4000	1.4225	1.3625	1.4000	1.4375	0.0560	0.0770	0.0980	0.0490	0.0770	0.1050
R3118x15xx	1.4775	1.5000	1.5225	1.4625	1.5000	1.5375	0.0600	0.0825	0.1050	0.0525	0.0825	0.1125
R3118x16xx	1.5760	1.6000	1.6240	1.5600	1.6000	1.6400	0.0640	0.0880	0.1120	0.0560	0.0880	0.1200
R3118x17xx	1.6745	1.7000	1.7255	1.6575	1.7000	1.7425	0.0680	0.0935	0.1190	0.0595	0.0935	0.1275
R3118x18xx	1.7730	1.8000	1.8270	1.7550	1.8000	1.8450	0.0720	0.0990	0.1260	0.0630	0.0990	0.1350
R3118x19xx	1.8715	1.9000	1.9285	1.8525	1.9000	1.9475	0.0760	0.1045	0.1330	0.0665	0.1045	0.1425
R3118x20xx	1.9700	2.0000	2.0300	1.9500	2.0000	2.0500	0.0800	0.1100	0.1400	0.0700	0.1100	0.1500
R3118x21xx	2.0685	2.1000	2.1315	2.0475	2.1000	2.1525	0.0840	0.1155	0.1470	0.0735	0.1155	0.1575
R3118x22xx	2.1670	2.2000	2.2330	2.1450	2.2000	2.2550	0.0880	0.1210	0.1540	0.0770	0.1210	0.1650
R3118x23xx	2.2655	2.3000	2.3345	2.2425	2.3000	2.3575	0.0920	0.1265	0.1610	0.0805	0.1265	0.1725
R3118x24xx	2.3640	2.4000	2.4360	2.3400	2.4000	2.4600	0.0960	0.1320	0.1680	0.0840	0.1320	0.1800
R3118x25xx	2.4625	2.5000	2.5375	2.4375	2.5000	2.5625	0.1000	0.1375	0.1750	0.0875	0.1375	0.1875
R3118x26xx	2.5610	2.6000	2.6390	2.5350	2.6000	2.6650	0.1040	0.1430	0.1820	0.0910	0.1430	0.1950
R3118x271x	2.6595	2.7000	2.7405	2.6325	2.7000	2.7675	0.1080	0.1485	0.1890	0.0945	0.1485	0.2025
R3118x28xx	2.7580	2.8000	2.8420	2.7300	2.8000	2.8700	0.1120	0.1540	0.1960	0.0980	0.1540	0.2100
R3118x29xx	2.8565	2.9000	2.9435	2.8275	2.9000	2.9725	0.1160	0.1595	0.2030	0.1015	0.1595	0.2175
R3118x30xx	2.9550	3.0000	3.0450	2.9250	3.0000	3.0750	0.1200	0.1650	0.2100	0.1050	0.1650	0.2250
R3118x31xx	3.0535	3.1000	3.1465	3.0225	3.1000	3.1775	0.1240	0.1705	0.2170	0.1085	0.1705	0.2325
R3118x32xx	3.1520	3.2000	3.2480	3.1200	3.2000	3.2800	0.1280	0.1760	0.2240	0.1120	0.1760	0.2400
R3118x33xx	3.2505	3.3000	3.3495	3.2175	3.3000	3.3825	0.1320	0.1815	0.2310	0.1155	0.1815	0.2475
R3118x34xx	3.3490	3.4000	3.4510	3.3150	3.4000	3.4850	0.1360	0.1870	0.2380	0.1190	0.1870	0.2550
R3118x35xx	3.4475	3.5000	3.5525	3.4125	3.5000	3.5875	0.1400	0.1925	0.2450	0.1225	0.1925	0.2625
R3118x36xx	3.5460	3.6000	3.6540	3.5100	3.6000	3.6900	0.1440	0.1980	0.2520	0.1260	0.1980	0.2700
R3118x37xx	3.6445	3.7000	3.7555	3.6075	3.7000	3.7925	0.1480	0.2035	0.2590	0.1295	0.2035	0.2775
R3118x38xx	3.7430	3.8000	3.8570	3.7050	3.8000	3.8950	0.1520	0.2090	0.2660	0.1330	0.2090	0.2850
R3118x39xx	3.8415	3.9000	3.9585	3.8025	3.9000	3.9975	0.1560	0.2145	0.2730	0.1365	0.2145	0.2925
R3118x40xx	3.9400	4.0000	4.0600	3.9000	4.0000	4.1000	0.1600	0.2200	0.2800	0.1400	0.2200	0.3000
R3118x41xx	4.0385	4.1000	4.1615	3.9975	4.1000	4.2025	0.1640	0.2255	0.2870	0.1435	0.2255	0.3075
R3118x42xx	4.1370	4.2000	4.2630	4.0950	4.2000	4.3050	0.1680	0.2310	0.2940	0.1470	0.2310	0.3150
R3118x43xx	4.2355	4.3000	4.3645	4.1925	4.3000	4.4075	0.1720	0.2365	0.3010	0.1505	0.2365	0.3225
R3118x44xx	4.3340	4.4000	4.4660	4.2900	4.4000	4.5100	0.1760	0.2420	0.3080	0.1540	0.2420	0.3300
R3118x45xx	4.4325	4.5000	4.5675	4.3875	4.5000	4.6125	0.1800	0.2475	0.3150	0.1575	0.2475	0.3375
R3118x46xx	4.5310	4.6000	4.6690	4.4850	4.6000	4.7150	0.1840	0.2530	0.3220	0.1610	0.2530	0.3450
R3118x47xx	4.6295	4.7000	4.7705	4.5825	4.7000	4.8175	0.1880	0.2585	0.3290	0.1645	0.2585	0.3525
R3118x48xx	4.7280	4.8000	4.8720	4.6800	4.8000	4.9200	0.1920	0.2640	0.3360	0.1680	0.2640	0.3600
R3118x49xx	4.8265	4.9000	4.9735	4.7775	4.9000	5.0225	0.1960	0.2695	0.3430	0.1715	0.2695	0.3675
R3118x50xx	4.9250	5.0000	5.0750	4.8750	5.0000	5.1250	0.2000	0.2750	0.3500	0.1750	0.2750	0.3750

# THEORY OF OPERATION

## R3118xxxxA (Nch. OPEN-DRAIN OUTPUT)



R3118xxxxA Block Diagram with External Capacitor



Step	1	2	3
Comparator (-) Pin Input Voltage	I	II	I
Comparator Output	L	H	L
Tr.1	OFF	ON	OFF
Output Tr. Nch	OFF	ON	OFF

$$I \quad \frac{R_b+R_c}{R_a+R_b+R_c} \times V_{SENSE}$$

$$II \quad \frac{R_b}{R_a+R_b} \times V_{SENSE}$$

Operation Diagram

Step 1. The output voltage is equal to the pull-up voltage.

Step 2. At Point "A",  $V_{REF} \leq V_{SENSE} \times (R_b+R_c)/(R_a+R_b+R_c)$  is true, as a result, the output of comparator is reversed from "L" to "H", therefore the output voltage becomes the GND level. The voltage level of Point A means a detector threshold voltage ( $-V_{DET}$ ). (When the supply voltage is lower than the minimum operating voltage, the operation of the output transistor becomes indefinite. The output voltage is equal to the GND level.)

Step 3. At Point "B",  $V_{REF} \leq V_{SENSE} \times R_b/(R_a+R_b)$  is true, as a result, the output of comparator is reversed from "H" to "L", then the output voltage is equal to the pull-up voltage. The voltage level of Point B means a released voltage ( $+V_{DET}$ ).

(1) The difference between a released voltage and a detector threshold voltage is a detector threshold hysteresis.



R3118xxxxC (CMOS OUTPUT)



R3118xxxC Block Diagram with External Capacitor



Step	1	2	3	
Comparator (-) Pin Input Voltage	I	II	I	
Comparator Output	L	H	L	
Tr.1	OFF	ON	OFF	
Output Tr.	Pch	ON	OFF	ON
	Nch	OFF	ON	OFF

$$I \quad \frac{Rb+Rc}{Ra+Rb+Rc} \times V_{SENSE}$$

$$II \quad \frac{Rb}{Ra+Rb} \times V_{SENSE}$$

Operation Diagram

- Step 1. The output voltage is equal to the supply voltage ( $V_{DD}$ ).
- Step 2. At Point "A",  $V_{REF} \geq V_{SENSE} \times (Rb+Rc)/(Ra+Rb+Rc)$  is true, as a result, the output of comparator is reversed from "L" to "H", therefore the output voltage becomes the GND level. The voltage level of Point A means a detector threshold voltage ( $-V_{DET}$ ). (When the supply voltage is lower than the minimum operating voltage, the operation of the output transistor becomes indefinite. The output voltage is equal to the GND level.)
- Step 3. At Point "B",  $V_{REF} \leq V_{SENSE} \times Rb/(Ra+Rb)$  is true, as a result, the output of comparator is reversed from "H" to "L", then the output voltage is equal to the supply voltage ( $V_{DD}$ ). The voltage level of Point B means a released voltage ( $+V_{DET}$ ).

(1) The difference between a released voltage and a detector threshold voltage is a detector threshold hysteresis.

**WHEN POWER TO SENSE PIN TURNING-ON AFTER VDD PIN'S POWER-ON**

If a voltage is applied to SENSE pin after a power (in the range from 1 V to 6 V) is applied to VDD pin, DOUT pin becomes "L" when the SENSE pin voltage is less than released voltage  $+V_{DET}$ , and DOUT pin becomes "H" when the SENSE pin voltage is equal or more than the released voltage  $+V_{DET}$ .

**WHEN POWER TO VDD PIN TURNING-ON AFTER SENSE PIN'S POWER-ON**



In the case of the SENSE pin voltage is less than released voltage  $+V_{DET}$ , when the  $V_{DD}$  pin voltage becomes to 1 V or more, "L" output of  $D_{OUT}$  is determined. In case of the SENSE pin voltage is equal or more than the released voltage  $+V_{DET}$ , when the  $V_{DD}$  pin voltage becomes to 1 V or more, "H" output of  $D_{OUT}$  is determined. If the turn on speed of the supply voltage of the  $V_{DD}$  pin up to 1 V is slower than the 1 V/s, connect 0.001  $\mu$ F or more capacitor to CD pin, otherwise, powering-up of the  $V_{DD}$  pin with the SENSE pin output voltage of  $-V_{DET} < V_{SENSE} < +V_{DET}$  may result in an unstable  $D_{OUT}$  pin output, "H" or "L", at the point where the  $V_{DD}$  pin voltage exceeds 1 V.

**TIMING CHART**



**OUTPUT DELAY OPERATION**

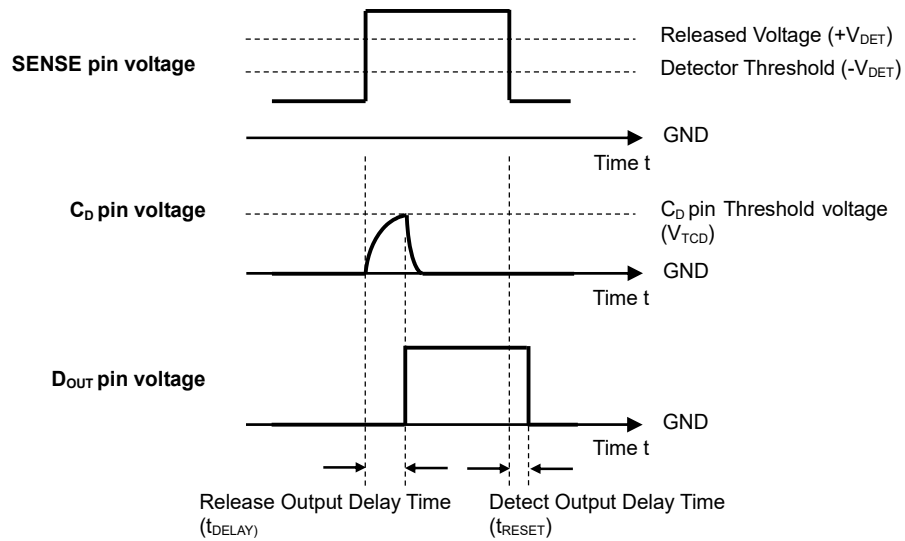

**Output Delay Operation Diagram**

A higher voltage than the released voltage is forced to the SENSE pin, charge to the capacitor connected to CD pin is started, then the CD pin voltage increases. Until CD pin voltage reaches to CD pin threshold voltage, the output of DOUT pin voltage keeps "L", then when CD pin voltage is higher than CD pin threshold voltage, the DOUT pin voltage changes from "L" to "H". The released output delay time means the time interval from when the released voltage threshold or more voltage level is forced to SENSE pin to when DOUT voltage changes from "L" to "H".

When the voltage of DOUT pin reverses from "L" to "H", the discharge of the external capacitor connected to CD pin starts. Therefore, the time interval from when the voltage lower than the detector threshold is forced to SENSE pin, to when the output voltage reverses from "H" to "L", or detector output delay time is constant and independent from the external capacitance value. However, after the DOUT pin voltage reverses from "L" to "H", if a voltage lower than the detector threshold is forced to SENSE pin before the capacitor connected to CD pin is discharged, delay time will increase. The time interval (t<sub>DIS</sub>) from when the capacitor connected to CD pin is discharged completely to when the capacitor is charged to a certain CD pin voltage (described as V<sub>CD</sub> herein) can be calculated by power supply voltage (V<sub>DD</sub>), external capacitance (C<sub>D</sub>), on resistance of the CD pin discharge transistor (R<sub>DIS</sub>) as in the next formula:

$$t_{DIS} = -R_{DIS} \times C_D \times \ln(V_{CD} / (V_{DD} \times 0.45))$$

**RELEASED OUTPUT DELAY TIME**

The release output delay time (t<sub>DELAY</sub>) can be calculated as in the next formula with an external capacitance value (C<sub>D</sub>):

$$t_{DELAY}(s) = 4.545 \times 106 \times C_D(F)$$

During the released delay operation, only a small current will charge the external capacitor connected to CD pin. If the leakage current between CD pin and GND is large, the released delay time may increase or the detector may not be released. And, if the VDD pin voltage varies, the released output delay time will be also shift.

## APPLICATION INFORMATION

### TYPICAL APPLICATION

#### R3118xxxxA (Nch. Open-drain Output) CPU Reset Circuit



When using a shared input voltage between R3118x and CPU

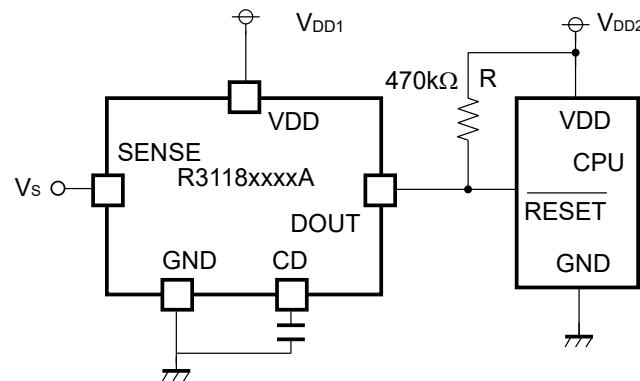

When using different input voltages between R3118x and CPU

#### R3118xxxxC (CMOS Output) CPU Reset Circuit

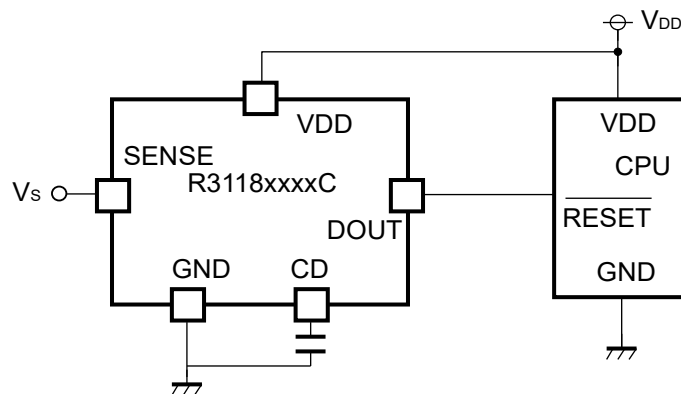

**TYPICAL CHARACTERISTICS**

Note: Typical Characteristics are intended to be used as reference data; they are not guaranteed.

**1) Supply Current vs. Supply Voltage**

**R3118xxxxA/C (V<sub>SENSE</sub> = 0 V)**



**R3118xxxxA/C (V<sub>SENSE</sub> = 6 V)**



**2) Detector Threshold vs. Temperature**

**R3118x06xA/C (V<sub>DD</sub> = 5.3 V)**

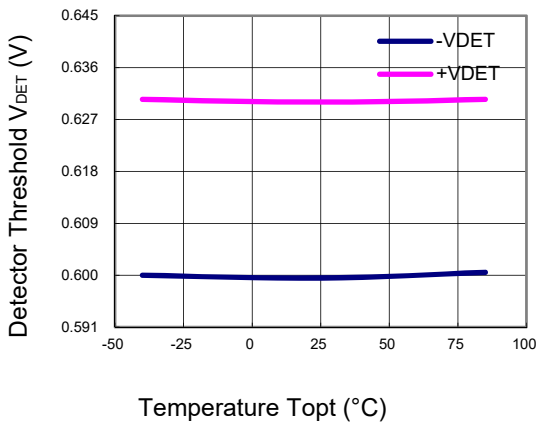

**R3118x27xA/C (V<sub>DD</sub> = 5.3 V)**



**R3118x50xA/C (V<sub>DD</sub> = 5.3 V)**

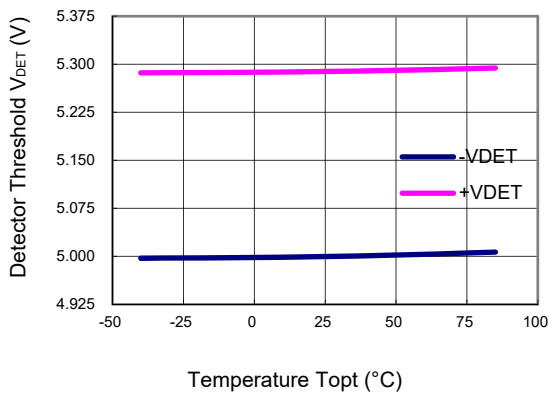

3) Detector Threshold vs. Supply Voltage



4) Hysteresis vs. Temperature



---

**R3118x**No. EA-242-201202

---

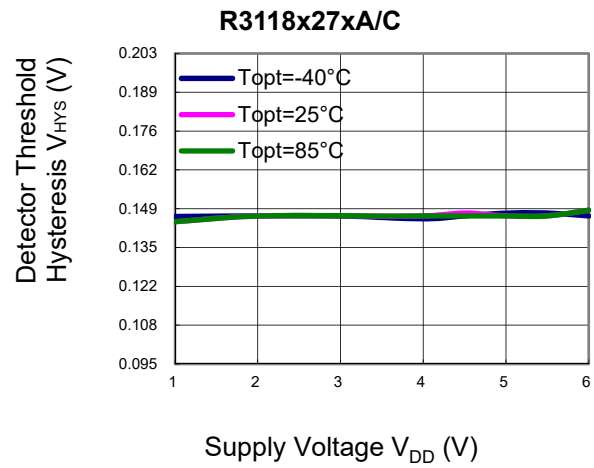
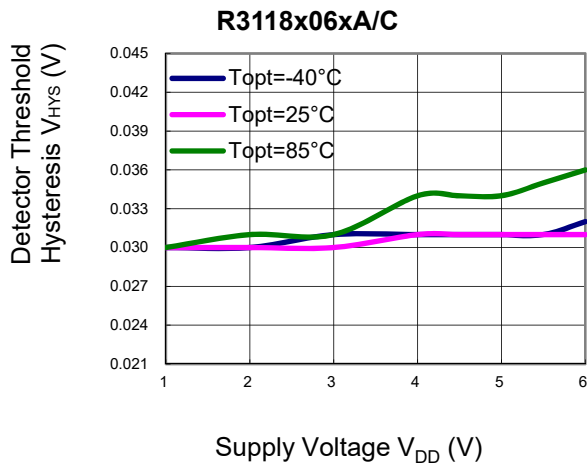
**5) Hysteresis vs. Supply Voltage**



6) Output Voltage vs. SENSE Voltage (DOUT pin is pulled up to VDD pin via 470 kΩ)



7) Nch. Driver Output Current vs. Supply Voltage



8) Nch. Driver Output Current vs. Output Voltage



**9) Pch. Driver Output Current vs. Supply Voltage**



**10) Pch Driver Output current vs. Output voltage**



**11) CD pin Discharge Tr. On Resistance vs. Supply Voltage**



**12) CD pin Discharge Transistor On Resistance vs. CD pin Voltage**



13) Release Output Delay Time vs. Temperature

R3118xxxxA/C ( $V_{DD} = 4\text{ V}$ ,  $C_D = 0.022\ \mu\text{F}$ )

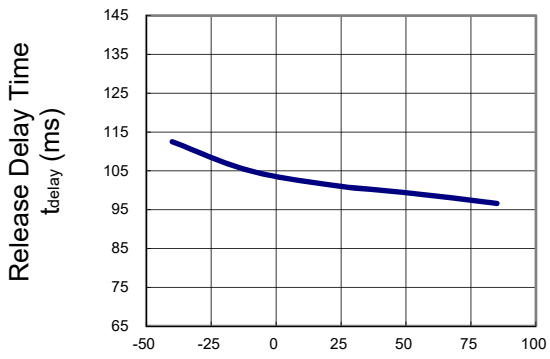

Temperature  $T_{opt}$  (°C)

14) Release Output Delay Time vs. Supply Voltage

R3118xxxxA/C ( $C_D = 0.022\ \mu\text{F}$ )

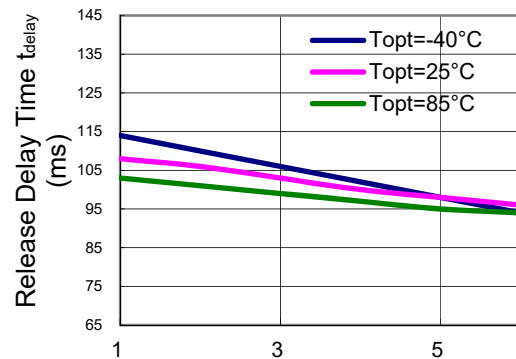

Supply Voltage  $V_{DD}$  (V)

15) Detect Output Delay Time/Release Output Delay Time vs. CD pin External Capacitance

R3118xxxxA/C ( $V_{DD} = 4\text{ V}$ )



External Capacitance  $C_D$  ( $\mu\text{F}$ )

16) Detect Output Delay time vs. Over-drive Voltage

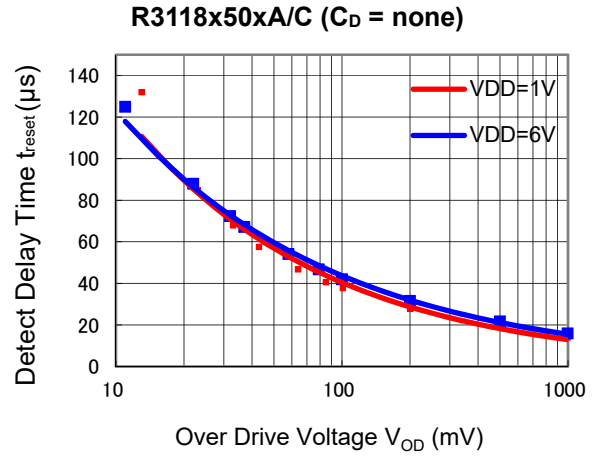
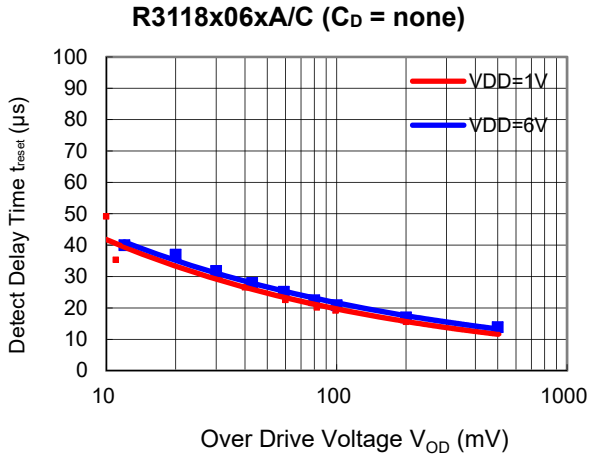

Note: The pulse shorter than the detect output delay time cannot be detected, and "L" does not output from DOUT pin.

17) Release Output Delay time vs. Over-drive Voltage



Notes:

- If the pulse is shorter than the output release delay time, the R3118x cannot be released and "H" does not output from DOUT pin.
- If the attachment capacitor for CD pin for setting a delay time is too small and the difference between the released voltage threshold and the actual released voltage is too small or the slope for rising voltage of the SENSE pin is too slow, the output delay time tolerance will be worse.

Ex. Attachment capacitor = 0.0001 µF, Released voltage threshold = 4.725 V, Actual released voltage = 4.75 V. In this case, the calculated delay time = 0.4545 ms, however, over-drive voltage is only 25 mV. Therefore, the actual delay time will be approximately 2.4545 ms. If the attachment capacitor = 0.001 µF and other conditions are same as above, the calculated delay time = 4.545 ms, and the actual delay time will be approximately 6.545 ms. If the attachment capacitor = 0.01 µF and other conditions are same as above, the calculated delay time = 45.45 ms, and the actual delay time will be approximately 47.45 ms.

The power dissipation of the package is dependent on PCB material, layout, and environmental conditions. The following measurement conditions are based on JEDEC STD. 51-7.

**Measurement Conditions**

Item	Measurement Conditions
Environment	Mounting on Board (Wind Velocity = 0 m/s)
Board Material	Glass Cloth Epoxy Plastic (Four-Layer Board)
Board Dimensions	76.2 mm × 114.3 mm × 0.8 mm
Copper Ratio	Outer Layer (First Layer): Less than 95% of 50 mm Square Inner Layers (Second and Third Layers): Approx. 100% of 50 mm Square Outer Layer (Fourth Layer): Approx. 100% of 50 mm Square
Through-holes	φ 0.2 mm × 14 pcs

**Measurement Result**

(Ta = 25°C, Tjmax = 125°C)

Item	Measurement Result
Power Dissipation	450 mW
Thermal Resistance (θja)	θja = 218°C/W
Thermal Characterization Parameter (ψjt)	ψjt = 105°C/W

θja: Junction-to-Ambient Thermal Resistance

ψjt: Junction-to-Top Thermal Characterization Parameter



**Power Dissipation vs. Ambient Temperature**



**Measurement Board Pattern**

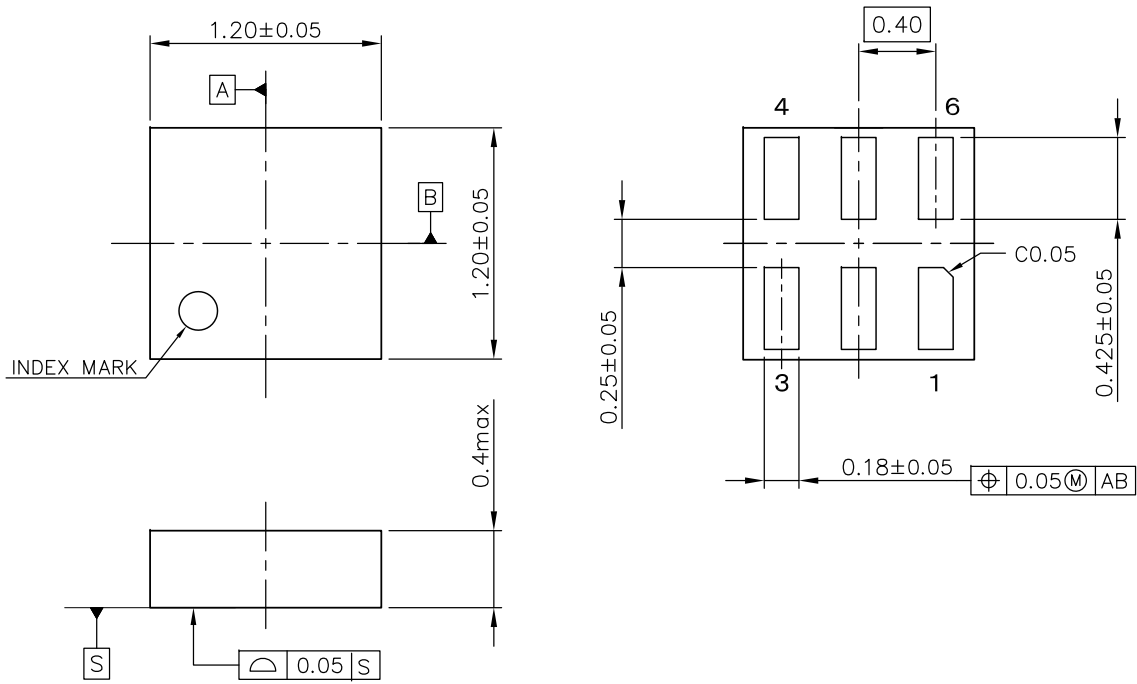

UNIT: mm

DFN(PLP)1212-6 Package Dimensions

The power dissipation of the package is dependent on PCB material, layout, and environmental conditions. The following conditions are used in this measurement.

**Measurement Conditions**

Item	Standard Test Land Pattern
Environment	Mounting on Board (Wind Velocity = 0 m/s)
Board Material	Glass Cloth Epoxy Plastic (Double-Sided Board)
Board Dimensions	40 mm × 40 mm × 1.6 mm
Copper Ratio	Top Side: Approx. 50% Bottom Side: Approx. 50%
Through-holes	φ 0.5 mm × 44 pcs

**Measurement Result**

(Ta = 25°C, Tjmax = 125°C)

Item	Standard Test Land Pattern
Power Dissipation	380 mW
Thermal Resistance ( $\theta_{ja}$ )	$\theta_{ja} = 263^{\circ}\text{C/W}$
Thermal Characterization Parameter ( $\psi_{jt}$ )	$\psi_{jt} = 75^{\circ}\text{C/W}$

$\theta_{ja}$ : Junction-to-Ambient Thermal Resistance

$\psi_{jt}$ : Junction-to-Top Thermal Characterization Parameter



**Power Dissipation vs. Ambient Temperature**



**Measurement Board Pattern**





The power dissipation of the package is dependent on PCB material, layout, and environmental conditions. The following measurement conditions are based on JEDEC STD. 51-7.

**Measurement Conditions**

Item	Measurement Conditions
Environment	Mounting on Board (Wind Velocity = 0 m/s)
Board Material	Glass Cloth Epoxy Plastic (Four-Layer Board)
Board Dimensions	76.2 mm × 114.3 mm × 0.8 mm
Copper Ratio	Outer Layer (First Layer): Less than 95% of 50 mm Square Inner Layers (Second and Third Layers): Approx. 100% of 50 mm Square Outer Layer (Fourth Layer): Approx. 100% of 50 mm Square
Through-holes	φ 0.3 mm × 7 pcs

**Measurement Result**

(Ta = 25°C, Tjmax = 125°C)

Item	Measurement Result
Power Dissipation	660 mW
Thermal Resistance (θja)	θja = 150°C/W
Thermal Characterization Parameter (ψjt)	ψjt = 51°C/W

θja: Junction-to-Ambient Thermal Resistance

ψjt: Junction-to-Top Thermal Characterization Parameter



**Power Dissipation vs. Ambient Temperature**



**Measurement Board Pattern**



UNIT: mm

SOT-23-5 Package Dimensions



1. The products and the product specifications described in this document are subject to change or discontinuation of production without notice for reasons such as improvement. Therefore, before deciding to use the products, please refer to Ricoh sales representatives for the latest information thereon.
2. The materials in this document may not be copied or otherwise reproduced in whole or in part without prior written consent of Ricoh.
3. Please be sure to take any necessary formalities under relevant laws or regulations before exporting or otherwise taking out of your country the products or the technical information described herein.
4. The technical information described in this document shows typical characteristics of and example application circuits for the products. The release of such information is not to be construed as a warranty of or a grant of license under Ricoh's or any third party's intellectual property rights or any other rights.
5. The products listed in this document are intended and designed for use as general electronic components in standard applications (office equipment, telecommunication equipment, measuring instruments, consumer electronic products, amusement equipment etc.). Those customers intending to use a product in an application requiring extreme quality and reliability, for example, in a highly specific application where the failure or misoperation of the product could result in human injury or death (aircraft, spacevehicle, nuclear reactor control system, traffic control system, automotive and transportation equipment, combustion equipment, safety devices, life support system etc.) should first contact us.
6. We are making our continuous effort to improve the quality and reliability of our products, but semiconductor products are likely to fail with certain probability. In order to prevent any injury to persons or damages to property resulting from such failure, customers should be careful enough to incorporate safety measures in their design, such as redundancy feature, fire containment feature and fail-safe feature. We do not assume any liability or responsibility for any loss or damage arising from misuse or inappropriate use of the products.
7. Anti-radiation design is not implemented in the products described in this document.
8. The X-ray exposure can influence functions and characteristics of the products. Confirm the product functions and characteristics in the evaluation stage.
9. WLCSP products should be used in light shielded environments. The light exposure can influence functions and characteristics of the products under operation or storage.
10. There can be variation in the marking when different AOI (Automated Optical Inspection) equipment is used. In the case of recognizing the marking characteristic with AOI, please contact Ricoh sales or our distributor before attempting to use AOI.
11. Please contact Ricoh sales representatives should you have any questions or comments concerning the products or the technical information.



**Ricoh is committed to reducing the environmental loading materials in electrical devices with a view to contributing to the protection of human health and the environment.**

Ricoh has been providing RoHS compliant products since April 1, 2006 and Halogen-free products since April 1, 2012.

**RICOH** RICOH ELECTRONIC DEVICES CO., LTD.

**Official website**

<https://www.n-redc.co.jp/en/>

**Contact us**

<https://www.n-redc.co.jp/en/buy/>

