



# PESDxS1UB series

ESD protection diodes in SOD523 package

Rev. 02 — 24 August 2009

Product data sheet

## 1. Product profile

### 1.1 General description

Unidirectional ESD protection diode in a SOD523 plastic package designed to protect one transmission or data line from the damage caused by ESD (ElectroStatic Discharge) and other transients.

### 1.2 Features

- Unidirectional ESD protection of one line
- Max. peak pulse power:  $P_{PP} = 330 \text{ W}$  at  $t_p = 8/20 \mu\text{s}$
- Low clamping voltage:  $V_{CL} = 20 \text{ V}$  at  $I_{PP} = 18 \text{ A}$
- Ultra low leakage current:  $I_{RM} < 700 \text{ nA}$
- ESD protection  $> 23 \text{ kV}$
- IEC 61000-4-2, level 4 (ESD)
- IEC 61000-4-5 (surge);  $I_{PP} = 18 \text{ A}$  at  $t_p = 8/20 \mu\text{s}$

### 1.3 Applications

- Computers and peripherals
- Communication systems
- Audio and video equipment
- Data lines
- CAN bus protection

### 1.4 Quick reference data

Table 1. Quick reference data



Symbol	Parameter	Conditions	Value	Unit
$V_{RWM}$	reverse standoff voltage			
	PESD3V3S1UB		3.3	V
	PESD5V0S1UB		5	V
	PESD12VS1UB		12	V
	PESD15VS1UB		15	V
	PESD24VS1UB		24	V

**Table 1. Quick reference data ...continued**

Symbol	Parameter	Conditions	Value	Unit
C <sub>d</sub>	diode capacitance	V <sub>R</sub> = 0 V; f = 1 MHz		
	PESD3V3S1UB		207	pF
	PESD5V0S1UB		152	pF
	PESD12VS1UB		38	pF
	PESD15VS1UB		32	pF
	PESD24VS1UB		23	pF
	number of protected lines		1	

## 2. Pinning information

**Table 2. Discrete pinning**

Pin	Description	Simplified outline	Symbol
1	cathode	[1]	 sym035
2	anode		

[1] The marking bar indicates the cathode.

## 3. Ordering information

**Table 3. Ordering information**

Type number	Package		Version
	Name	Description	
PESDxS1UB	SC -79	plastic surface mounted package; 2 leads	SOD523

## 4. Marking

**Table 4. Marking**

Type number	Marking code
PESD3V3S1UB	N1
PESD5V0S1UB	N2
PESD12VS1UB	N3
PESD15VS1UB	N4
PESD24VS1UB	N5

## 5. Limiting values

**Table 5. Limiting values**

In accordance with the Absolute Maximum Rating System (IEC 60134).

Symbol	Parameter	Conditions	Min	Max	Unit
P <sub>PP</sub>	peak pulse power	8/20 μs	[1]		
	PESD3V3S1UB		-	330	W
	PESD5V0S1UB		-	260	W
	PESD12VS1UB		-	180	W
	PESD15VS1UB		-	160	W
	PESD24VS1UB		-	160	W
I <sub>PP</sub>	peak pulse current	8/20 μs	[1]		
	PESD3V3S1UB		-	18	A
	PESD5V0S1UB		-	15	A
	PESD12VS1UB		-	5	A
	PESD15VS1UB		-	5	A
	PESD24VS1UB		-	3	A
T <sub>j</sub>	junction temperature		-	150	°C
T <sub>amb</sub>	operating ambient temperature		-65	+150	°C
T <sub>stg</sub>	storage temperature		-65	+150	°C

[1] Non-repetitive current pulse 8/20 μs exponentially decay waveform; see [Figure 1](#).

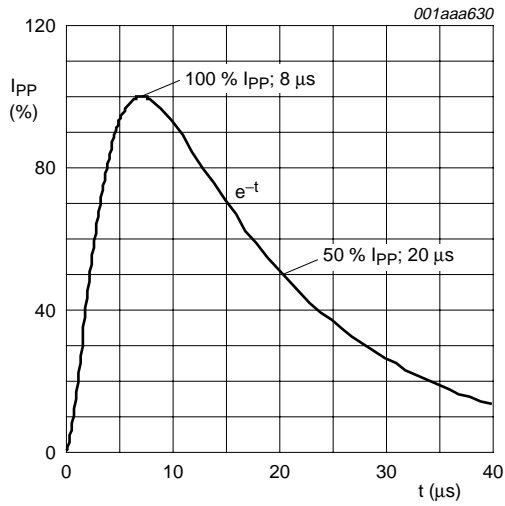
**Table 6. ESD maximum ratings**

Symbol	Parameter	Conditions	Min	Max	Unit
ESD	electrostatic discharge capability	IEC 61000-4-2 (contact discharge)	[1]		
	PESD3V3S1UB		-	30	kV
	PESD5V0S1UB		-	30	kV
	PESD12VS1UB		-	30	kV
	PESD15VS1UB		-	30	kV
	PESD24VS1UB		-	23	kV
	PESDxS1UB series	HBM MIL-STD883	-	10	kV

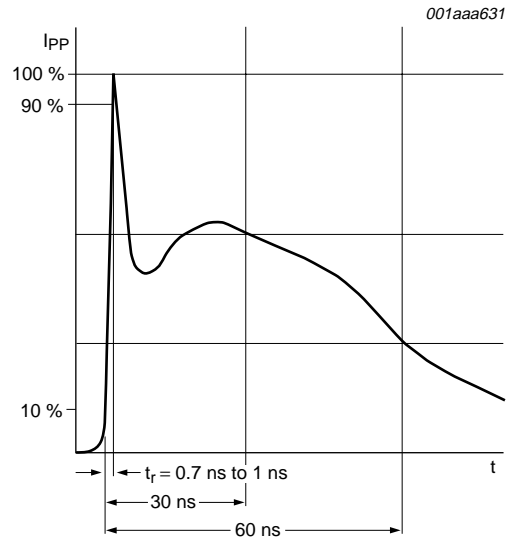
[1] Device stressed with ten non-repetitive ElectroStatic Discharge (ESD) pulses; see [Figure 2](#).

**Table 7. ESD standards compliance**

Standard	Conditions
IEC 61000-4-2, level 4 (ESD)	> 15 kV (air); > 8 kV (contact)
HBM MIL-STD883, class 3	> 4 kV



**Fig 1. 8/20 μs pulse waveform according to IEC 61000-4-5**



**Fig 2. ElectroStatic Discharge (ESD) pulse waveform according to IEC 61000-4-2**

## 6. Characteristics

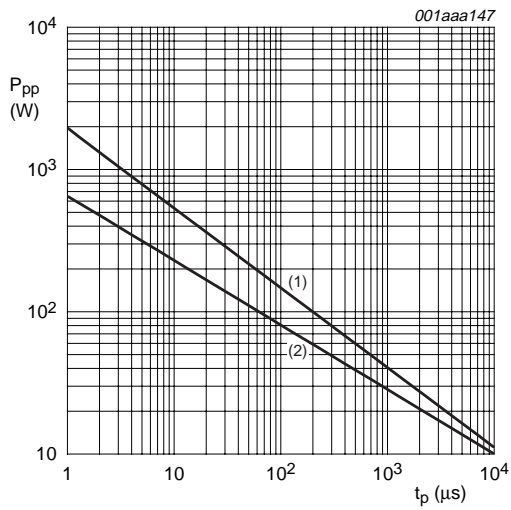
**Table 8. Characteristics**
 $T_{amb} = 25\text{ }^{\circ}\text{C}$  unless otherwise specified

Symbol	Parameter	Conditions	Min	Typ	Max	Unit
$V_{RWM}$	reverse standoff voltage					
	PESD3V3S1UB		-	-	3.3	V
	PESD5V0S1UB		-	-	5	V
	PESD12VS1UB		-	-	12	V
	PESD15VS1UB		-	-	15	V
	PESD24VS1UB		-	-	24	V
$I_{RM}$	reverse leakage current	see <a href="#">Figure 7</a>				
	PESD3V3S1UB	$V_{RWM} = 3.3\text{ V}$	-	0.7	2	$\mu\text{A}$
	PESD5V0S1UB	$V_{RWM} = 5\text{ V}$	-	0.1	1	$\mu\text{A}$
	PESD12VS1UB	$V_{RWM} = 12\text{ V}$	-	< 1	50	nA
	PESD15VS1UB	$V_{RWM} = 15\text{ V}$	-	< 1	50	nA
	PESD24VS1UB	$V_{RWM} = 24\text{ V}$	-	< 1	50	nA
$V_{BR}$	breakdown voltage	$I_R = 5\text{ mA}$				
	PESD3V3S1UB		5.2	5.6	6.0	V
	PESD5V0S1UB		6.4	6.8	7.2	V
	PESD12VS1UB		14.7	15.0	15.3	V
	PESD15VS1UB		17.6	18.0	18.4	V
	PESD24VS1UB		26.5	27.0	27.5	V
$C_d$	diode capacitance	$V_R = 0\text{ V}$ ; $f = 1\text{ MHz}$ ; see <a href="#">Figure 5</a> and <a href="#">6</a>				
	PESD3V3S1UB		-	207	300	pF
	PESD5V0S1UB		-	152	200	pF
	PESD12VS1UB		-	38	75	pF
	PESD15VS1UB		-	32	70	pF
	PESD24VS1UB		-	23	50	pF
$V_{(CLR)}$	clamping voltage			<a href="#">[1]</a>		
	PESD3V3S1UB	$I_{PP} = 1\text{ A}$	-	-	7	V
		$I_{PP} = 18\text{ A}$	-	-	20	V
	PESD5V0S1UB	$I_{PP} = 1\text{ A}$	-	-	9	V
		$I_{PP} = 15\text{ A}$	-	-	20	V
	PESD12VS1UB	$I_{PP} = 1\text{ A}$	-	-	19	V
		$I_{PP} = 5\text{ A}$	-	-	35	V
	PESD15VS1UB	$I_{PP} = 1\text{ A}$	-	-	23	V
		$I_{PP} = 5\text{ A}$	-	-	40	V
	PESD24VS1UB	$I_{PP} = 1\text{ A}$	-	-	36	V
		$I_{PP} = 3\text{ A}$	-	-	70	V

**Table 8. Characteristics ...continued** $T_{amb} = 25\text{ }^{\circ}\text{C}$  unless otherwise specified

Symbol	Parameter	Conditions	Min	Typ	Max	Unit
$R_{diff}$	differential resistance					
	PESD3V3S1UB	$I_R = 1\text{ mA}$	-	-	400	$\Omega$
	PESD5V0S1UB	$I_R = 1\text{ mA}$	-	-	80	$\Omega$
	PESD12VS1UB	$I_R = 1\text{ mA}$	-	-	200	$\Omega$
	PESD15VS1UB	$I_R = 1\text{ mA}$	-	-	225	$\Omega$
	PESD24VS1UB	$I_R = 0.5\text{ mA}$	-	-	300	$\Omega$

[1] Non-repetitive current pulse 8/20  $\mu\text{s}$  exponentially decay waveform; see [Figure 1](#).

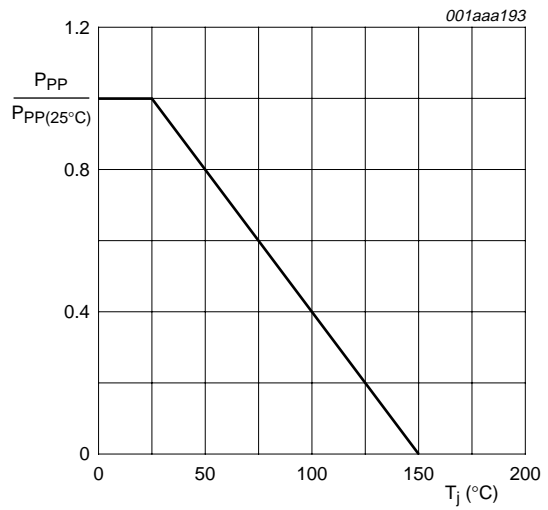


$T_{amb} = 25\text{ }^{\circ}\text{C}$

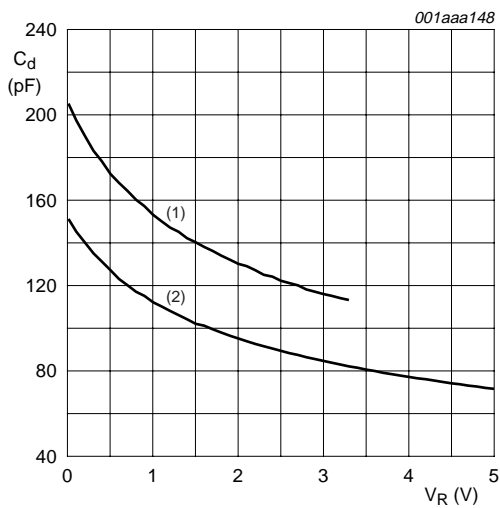
$t_p = 8/20\text{ }\mu\text{s}$  exponentially decay waveform, see [Figure 1](#)

- (1) PESD3V3S1UB and PESD5V0S1UB
- (2) PESD12VS1UB, PESD15VS1UB; PESD24VS1UB

**Fig 3. Peak pulse power dissipation as a function of pulse time; typical values**



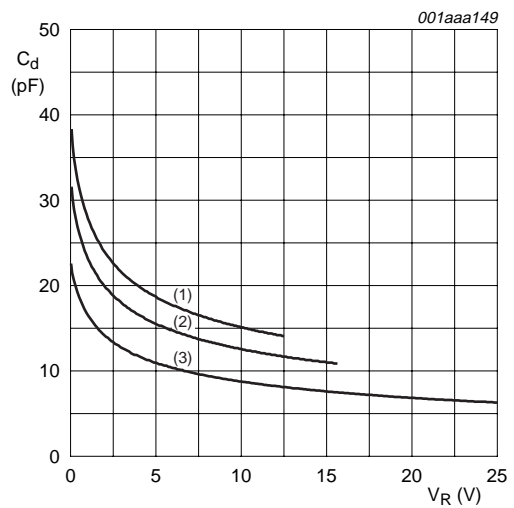
**Fig 4. Relative variation of peak pulse power as a function of junction temperature; typical values**



$f = 1\text{ MHz}; T_{amb} = 25\text{ }^{\circ}\text{C}$

- (1) PESD3V3S1UB
- (2) PESD5V0S1UB

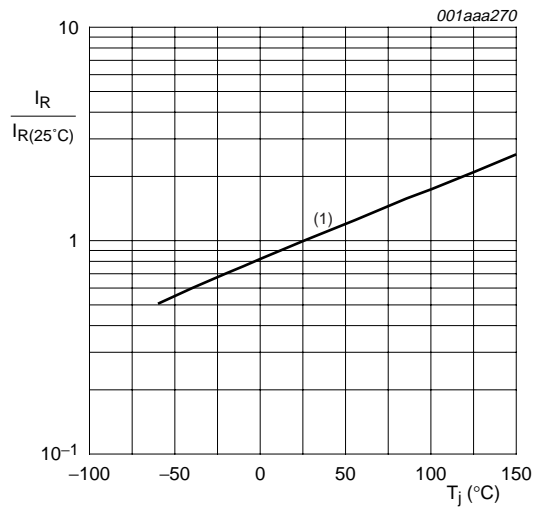
**Fig 5. Diode capacitance as a function of reverse voltage; typical values**



$f = 1\text{ MHz}; T_{amb} = 25\text{ }^{\circ}\text{C}$

- (1) PESD12VS1UB
- (2) PESD15VS1UB
- (3) PESD24VS1UB

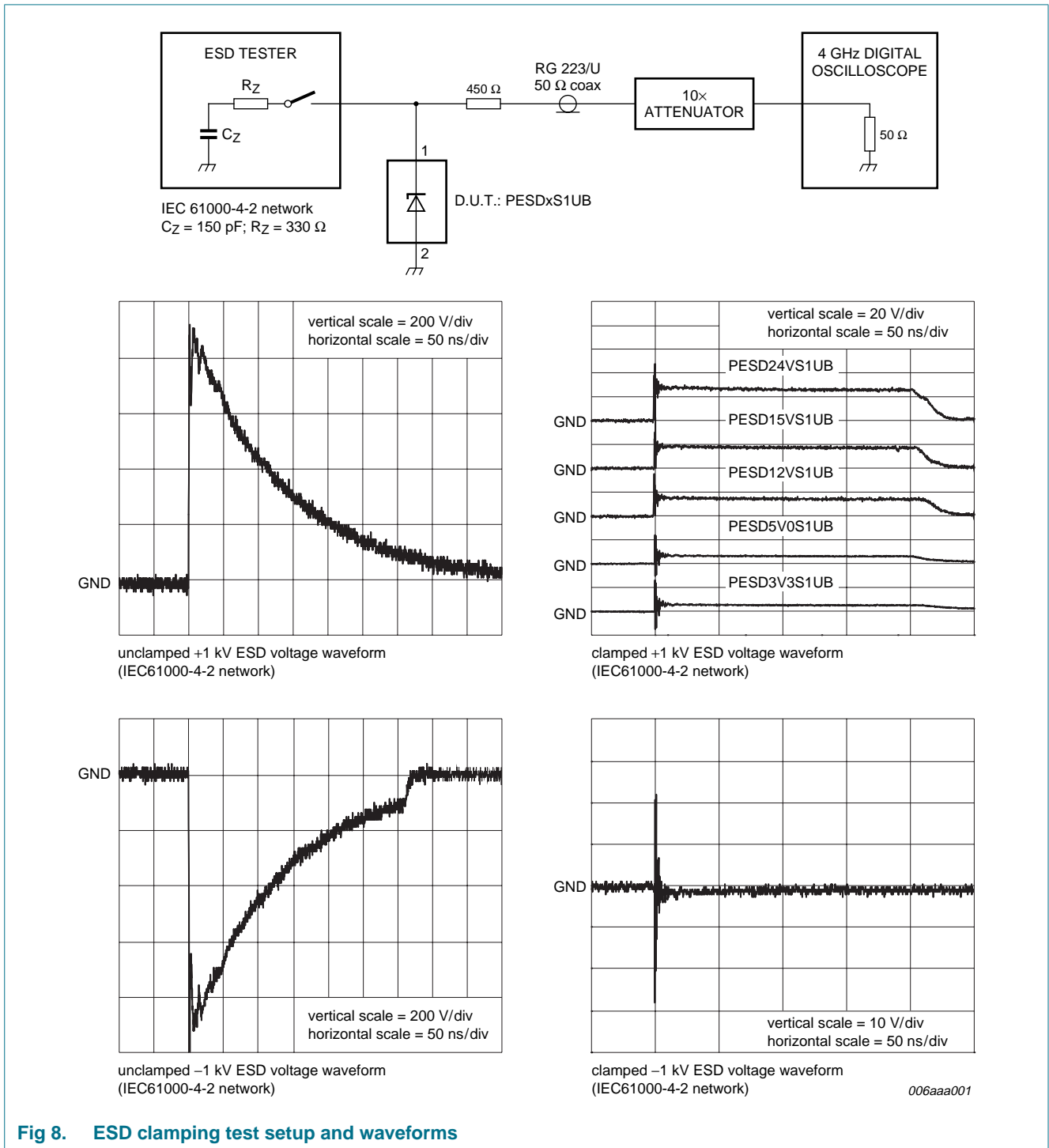
**Fig 6. Diode capacitance as a function of reverse voltage; typical values**



- (1) PESD3V3S1UB;  $V_{RWM} = 3.3$  V
- PESD5V0S1UB;  $V_{RWM} = 5$  V
- $I_R$  is less than 10 nA at 150 °C for:
- PESD12VS1UB;  $V_{RWM} = 12$  V
- PESD15VS1UB;  $V_{RWM} = 15$  V
- PESD24VS1UB;  $V_{RWM} = 24$  V

**Fig 7. Relative variation of reverse leakage current as a function of junction temperature; typical values**

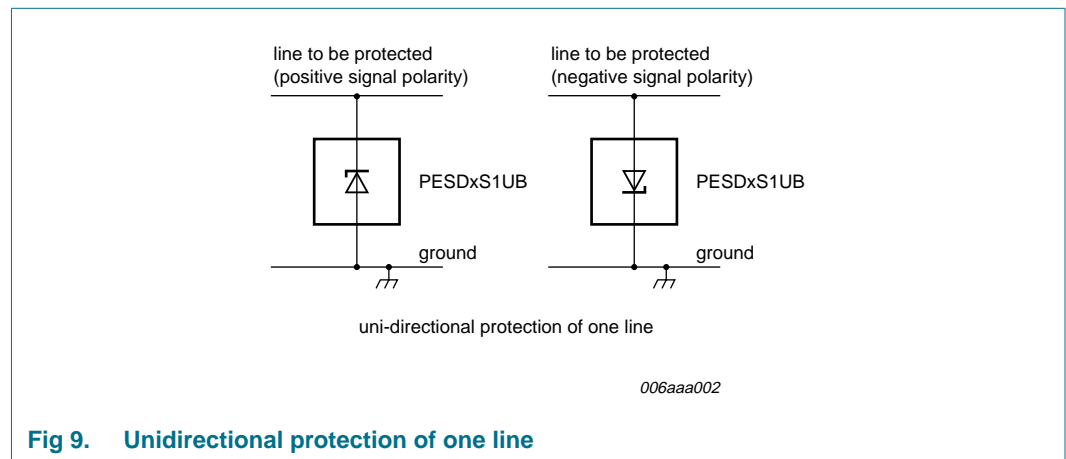




**Fig 8. ESD clamping test setup and waveforms**

## 7. Application information

The PESDxS1UB series is designed for unidirectional protection of one single data line from the damage caused by ESD (ElectroStatic Discharge) and Surge Pulses. The PESDxS1UB series may be used on lines where the signal polarity is above or below ground. The PESDxS1UB series provides a surge capability of up to 330 Watts per line for a 8/20  $\mu$ s waveform.



**Fig 9. Unidirectional protection of one line**

Circuit board layout and protection device placement:

Circuit board layout is critical for the suppression of ESD, EFT and Surge transients. The following guidelines are recommended:

1. Place the protection device as close to the input terminal or connector as possible.
2. The path length between the protection device and the protected line should be minimized.
3. Keep parallel signal paths to a minimum.
4. Avoid running protection conductors in parallel with unprotected conductor.
5. Minimize all printed-circuit board conductive loops including power and ground loops.
6. Minimize the length of the transient return path to ground.
7. Avoid using shared transient return paths to a common ground point.
8. Ground planes should be used whenever possible. For multilayer printed-circuit boards, use ground vias.

## 8. Package outline

Plastic surface-mounted package; 2 leads

SOD523

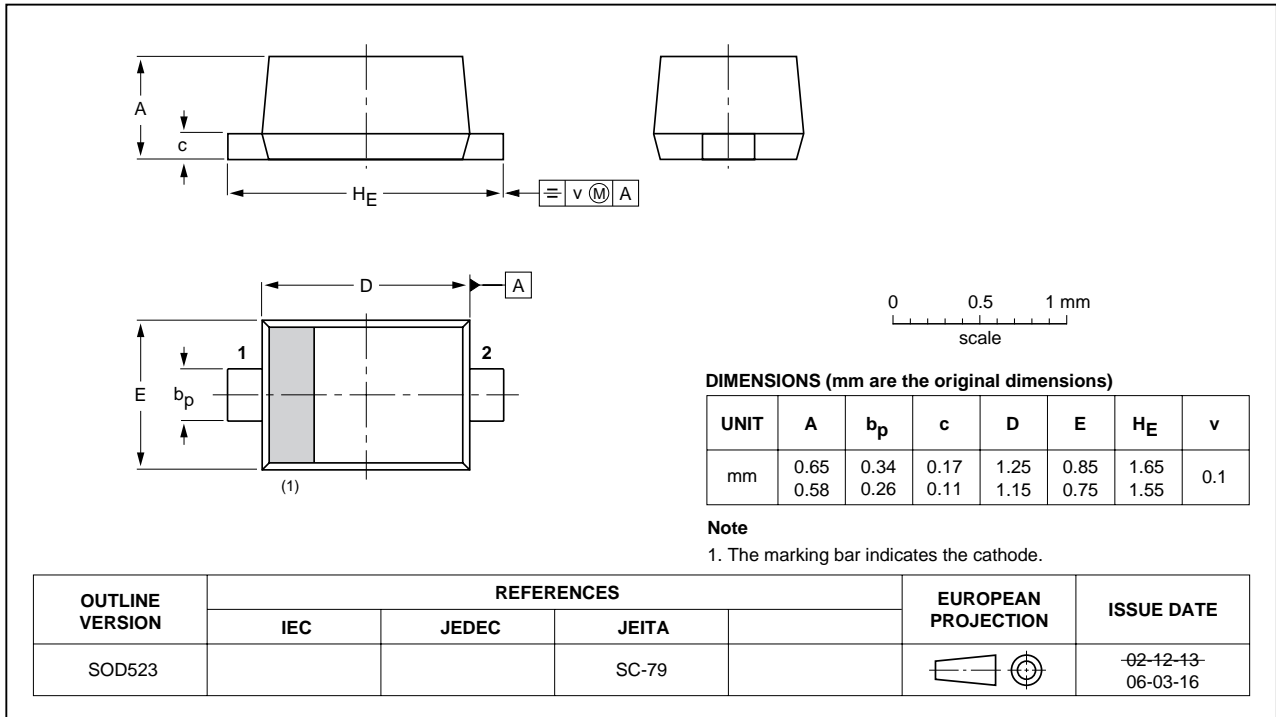


Fig 10. Package outline

## 9. Packing information

**Table 9. Possible packing methods**

The indicated -xxx are the last three digits of the 12 NC ordering code.<sup>[1]</sup>

Type number	Package	Description	Packing quantity	
			3000	10000
PESD3V3S1UB	SOD523	4 mm pitch, 8 mm tape and reel	-115	-135
PESD5V0S1UB	SOD523	4 mm pitch, 8 mm tape and reel	-115	-135
PESD12VS1UB	SOD523	4 mm pitch, 8 mm tape and reel	-115	-135
PESD15VS1UB	SOD523	4 mm pitch, 8 mm tape and reel	-115	-135
PESD24VS1UB	SOD523	4 mm pitch, 8 mm tape and reel	-115	-135

[1] For further information see [Section 12](#).

## 10. Revision history

**Table 10. Revision history**

Document ID	Release date	Data sheet status	Change notice	Supersedes
PESDXS1UB_SERIES_2	20090824	Product data	-	PESDXS1UB_SERIES_1
Modifications:	<ul style="list-style-type: none"> <li>This data sheet was changed to reflect the new company name NXP Semiconductors, including new legal definitions and disclaimers. No changes were made to the technical content.</li> <li><a href="#">Figure 10 "Package outline"</a>: updated</li> </ul>			
PESDXS1UB_SERIES_1	20040614	Product data	-	-

## 11. Legal information

### 11.1 Data sheet status

Document status <sup>[1][2]</sup>	Product status <sup>[3]</sup>	Definition
Objective [short] data sheet	Development	This document contains data from the objective specification for product development.
Preliminary [short] data sheet	Qualification	This document contains data from the preliminary specification.
Product [short] data sheet	Production	This document contains the product specification.

[1] Please consult the most recently issued document before initiating or completing a design.

[2] The term 'short data sheet' is explained in section "Definitions".

[3] The product status of device(s) described in this document may have changed since this document was published and may differ in case of multiple devices. The latest product status information is available on the Internet at URL <http://www.nxp.com>.

### 11.2 Definitions

**Draft** — The document is a draft version only. The content is still under internal review and subject to formal approval, which may result in modifications or additions. NXP Semiconductors does not give any representations or warranties as to the accuracy or completeness of information included herein and shall have no liability for the consequences of use of such information.

**Short data sheet** — A short data sheet is an extract from a full data sheet with the same product type number(s) and title. A short data sheet is intended for quick reference only and should not be relied upon to contain detailed and full information. For detailed and full information see the relevant full data sheet, which is available on request via the local NXP Semiconductors sales office. In case of any inconsistency or conflict with the short data sheet, the full data sheet shall prevail.

### 11.3 Disclaimers

**General** — Information in this document is believed to be accurate and reliable. However, NXP Semiconductors does not give any representations or warranties, expressed or implied, as to the accuracy or completeness of such information and shall have no liability for the consequences of use of such information.

**Right to make changes** — NXP Semiconductors reserves the right to make changes to information published in this document, including without limitation specifications and product descriptions, at any time and without notice. This document supersedes and replaces all information supplied prior to the publication hereof.

**Suitability for use** — NXP Semiconductors products are not designed, authorized or warranted to be suitable for use in medical, military, aircraft, space or life support equipment, nor in applications where failure or malfunction of an NXP Semiconductors product can reasonably be expected to result in personal injury, death or severe property or environmental

damage. NXP Semiconductors accepts no liability for inclusion and/or use of NXP Semiconductors products in such equipment or applications and therefore such inclusion and/or use is at the customer's own risk.

**Applications** — Applications that are described herein for any of these products are for illustrative purposes only. NXP Semiconductors makes no representation or warranty that such applications will be suitable for the specified use without further testing or modification.

**Limiting values** — Stress above one or more limiting values (as defined in the Absolute Maximum Ratings System of IEC 60134) may cause permanent damage to the device. Limiting values are stress ratings only and operation of the device at these or any other conditions above those given in the Characteristics sections of this document is not implied. Exposure to limiting values for extended periods may affect device reliability.

**Terms and conditions of sale** — NXP Semiconductors products are sold subject to the general terms and conditions of commercial sale, as published at <http://www.nxp.com/profile/terms>, including those pertaining to warranty, intellectual property rights infringement and limitation of liability, unless explicitly otherwise agreed to in writing by NXP Semiconductors. In case of any inconsistency or conflict between information in this document and such terms and conditions, the latter will prevail.

**No offer to sell or license** — Nothing in this document may be interpreted or construed as an offer to sell products that is open for acceptance or the grant, conveyance or implication of any license under any copyrights, patents or other industrial or intellectual property rights.

**Export control** — This document as well as the item(s) described herein may be subject to export control regulations. Export might require a prior authorization from national authorities.

**Quick reference data** — The Quick reference data is an extract of the product data given in the Limiting values and Characteristics sections of this document, and as such is not complete, exhaustive or legally binding.

### 11.4 Trademarks

Notice: All referenced brands, product names, service names and trademarks are the property of their respective owners.

## 12. Contact information

For more information, please visit: <http://www.nxp.com>

For sales office addresses, please send an email to: [salesaddresses@nxp.com](mailto:salesaddresses@nxp.com)

### 13. Contents

<b>1</b>	<b>Product profile</b> .....	<b>1</b>
1.1	General description .....	1
1.2	Features .....	1
1.3	Applications .....	1
1.4	Quick reference data .....	1
<b>2</b>	<b>Pinning information</b> .....	<b>2</b>
<b>3</b>	<b>Ordering information</b> .....	<b>2</b>
<b>4</b>	<b>Marking</b> .....	<b>2</b>
<b>5</b>	<b>Limiting values</b> .....	<b>3</b>
<b>6</b>	<b>Characteristics</b> .....	<b>5</b>
<b>7</b>	<b>Application information</b> .....	<b>10</b>
<b>8</b>	<b>Package outline</b> .....	<b>11</b>
<b>9</b>	<b>Packing information</b> .....	<b>12</b>
<b>10</b>	<b>Revision history</b> .....	<b>13</b>
<b>11</b>	<b>Legal information</b> .....	<b>14</b>
11.1	Data sheet status .....	14
11.2	Definitions .....	14
11.3	Disclaimers .....	14
11.4	Trademarks .....	14
<b>12</b>	<b>Contact information</b> .....	<b>14</b>
<b>13</b>	<b>Contents</b> .....	<b>15</b>



Please be aware that important notices concerning this document and the product(s) described herein, have been included in section 'Legal information'.

© NXP B.V. 2009.

All rights reserved.

For more information, please visit: <http://www.nxp.com>

For sales office addresses, please send an email to: [salesaddresses@nxp.com](mailto:salesaddresses@nxp.com)

Date of release: 24 August 2009

Document identifier: PESDxS1UB\_SERIES\_2