

## Photo DMOS-FET Relay

### Description

The **LTU320** is a miniature 1-Form A and 1-Form B solid state relay in a 8 pin SOP package that employs optically coupled MOSFET technology to provide 1500V of input to output isolation. The optically coupled input is controlled by a highly efficient GaAlAs infrared LED and MOS FETs on the output side.

### Features

- SOP package 8 Pin type in miniature design (4.4×9.4×2.0mm / .173×.37×.083inch)
- Low driver power requirements (TTL/CMOS Compatible)
- Contact form: Normally-On (1b) and Normally-Off (1a)
- Load voltage: 400V max.
- On-Resistance: 50Ω max.
- 1500Vrms Input/Output isolation
- Tape & Reel version available

### Applications

- Telecommunications (PC, Electronic notepad)
- Measuring and Testing equipment
- Industrial control
- Security equipments
- High speed inspection machine

### Outline Dimensions

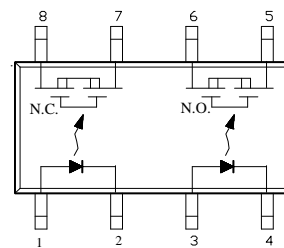
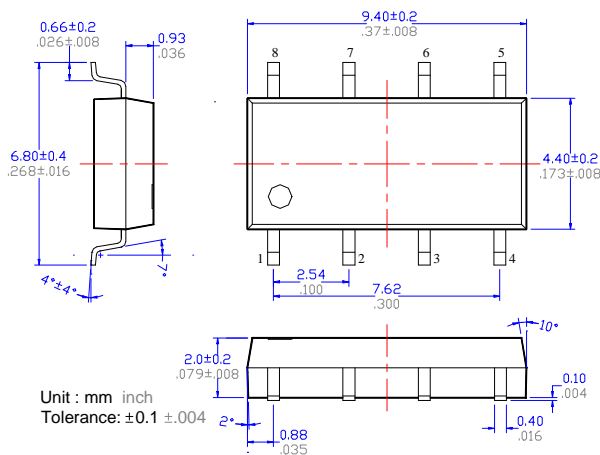

- 1,3. LED Anode
- 2,4. LED Cathode
- 5,6. Drain (MOS FET)1a
- 7,8. Drain (MOS FET)1b

## Photo DMOS-FET Relay Specifications

**Part Name: LTU320**

Absolute Maximum Ratings (Ambient Temperature: 25°C)

Item		Symbol	Value	Units	Note
Input	Continuous LED Current	IF	50	mA	
	Peak LED Current	IFP	500	mA	f=100Hz, duty=1%
	LED Reverse Voltage	VR	5	V	
	Input Power Dissipation	PIn	75	mW	
Output	Load Voltage	VL	400	V(AC peak or DC)	
	Load Current	IL	120	mA	
	Peak Load Current	I <sub>Peak</sub>	0.6	A	1ms(1 pulse)
	Output Power Dissipation	P <sub>out</sub>	450	mW	
Total Power Dissipation		PT	500	mW	
I/O Breakdown Voltage		VI/O	1500	V <sub>rms</sub>	RH=60%, 1min
Operating Temperature		T <sub>Op</sub>	-40 to +85	-40 to +85	
Storage Temperature		T <sub>Stg</sub>	-40 to +100	-40 to +100	
Pin Soldering Temperature		T <sub>Sol</sub>	260	260	10 sec max.

Electrical Specifications (Ambient Temperature: 25°C)

Item		Symbol	MIN.	TYP.	MAX.	Units	Conditions
Input	LED Forward Voltage	V <sub>F</sub>		1.2	1.4	V	I <sub>F</sub> =10mA
	Operation LED Current	I <sub>F On</sub>		0.5	3.0	mA	
	Recovery LED Current	I <sub>F Off</sub>		0.35	0.5	mA	
	Recovery LED Voltage	V <sub>F Off</sub>	0.5			V	
Output	On-Resistance	R <sub>On</sub>		20(NO) 20(NC)	30(NO) 50(NC)	Ω	I <sub>F</sub> =5mA (N.O.) I <sub>F</sub> =0mA (N.C) I <sub>L</sub> =100mA Time to flow is within 1 sec.
	Off-State Leakage Current	I <sub>Leak</sub>			1(NO) 10(NC)	uA	I <sub>F</sub> =0mA (N.O.) I <sub>F</sub> =5mA (N.C) V <sub>L</sub> =400V
	Output Capacitance	C <sub>Out</sub>		165		pF	I <sub>F</sub> =5mA, V <sub>L</sub> =0, f=1MHz
Transmission	Turn-On Time	T <sub>On</sub>		0.23(N.O.)	1.0	ms	I <sub>F</sub> =5mA, I <sub>L</sub> =50mA
				0.5(N.C.)	1.0		
	Turn-Off Time	T <sub>Off</sub>		0.03(N.O.)	2.0	ms	
				0.5(N.C.)	2.0		
Coupled	I/O Isolation Resistance	R <sub>I/O</sub>	10 <sup>10</sup>			Ω	DC500V
	I/O Capacitance	C <sub>I/O</sub>		0.8		pF	f=1MHz

# Reference Data

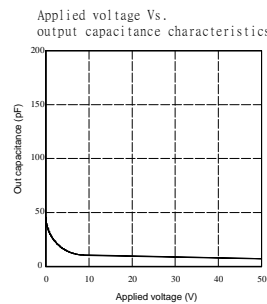
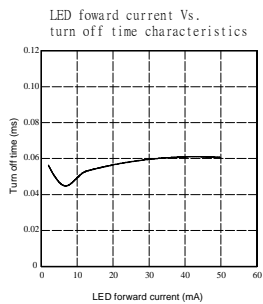
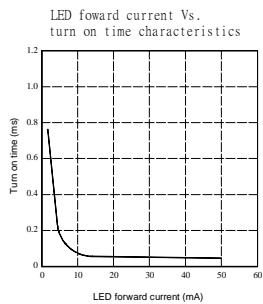
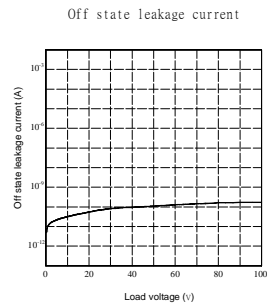
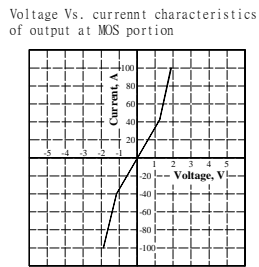
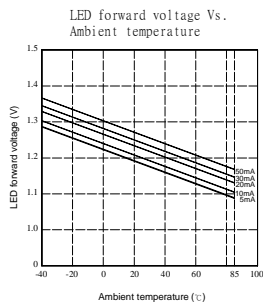
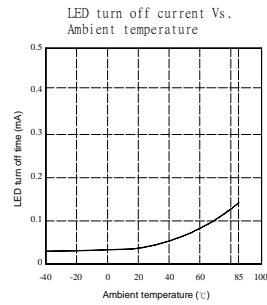
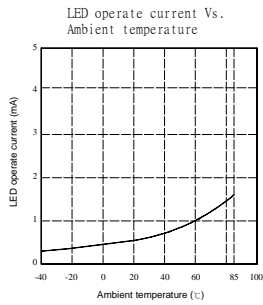
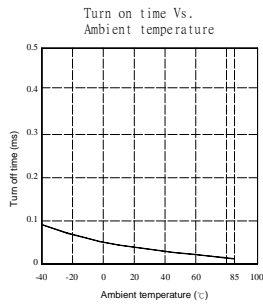
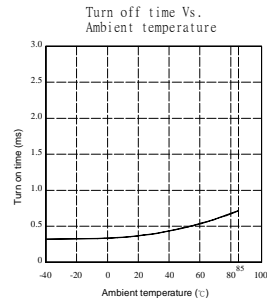
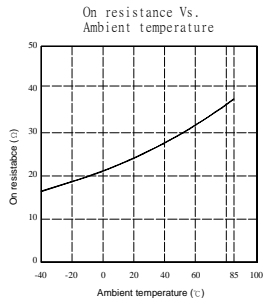
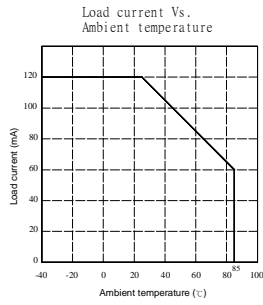

## Taping Specifications for Surface Mount Devices

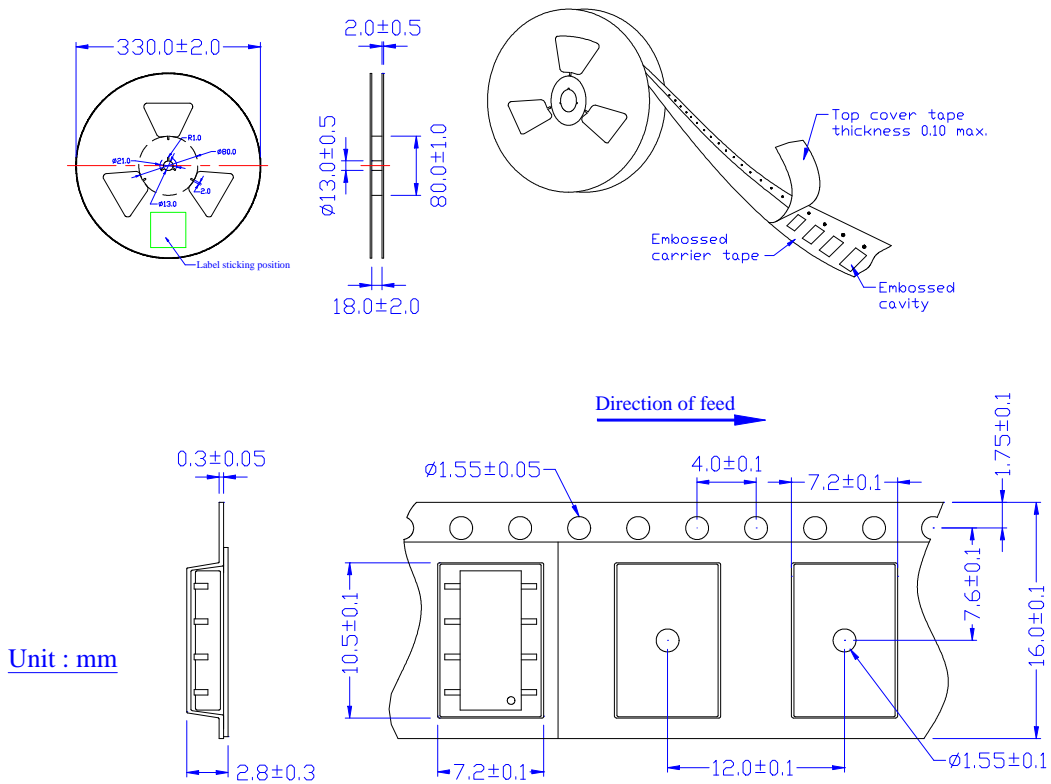

### Recommended Mounting Pad

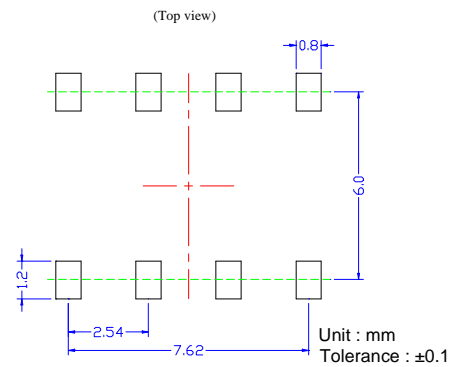

### Marking

(Each photo MOS Relay shall be marked with the following information)

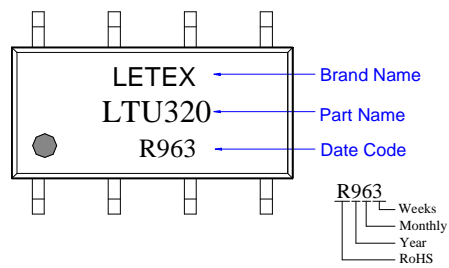

- Note:
1. There shall be leader of 230 mm minimum which may consist of carrier and or cover tape follower by a minimum of 160 mm of carrier tape sealed with cover tape.
  2. There shall be a minimum of 160 mm of empty component pockets sealed with cover tape.
  3. Devices are pockets in accordance with EIA standard EIA-481-A and specifications given above.
  4. Packaging: 1,000pcs per reel, 2 reel per box, 5 boxes per carton.