

## Photo DMOS-FET Relay

### Description

The **LT218D** is a miniature 1-Form A solid state relay in a 4 pin SOP package that employs optically coupled MOSFET technology to provide 1500V of input to output isolation. The optically coupled input is controlled by a highly efficient GaAlAs infrared LED and MOS FETs on the output side.

### Features

- SOP package 4 Pin type in miniature design (4.4×4.3×2.0mm / .173×.169×.083inch)
- Low driver power requirements (TTL/CMOS Compatible)
- No moving parts
- High reliability
- Arc-Free with no snubbing circuits
- 1500Vrms Input/Output isolation
- Tape & Reel version available

### Applications

- Telecommunications (PC, Electronic notepad)
- Measuring and Testing equipment
- Industrial control
- Security equipments
- High speed inspection machine

### Outline Dimensions

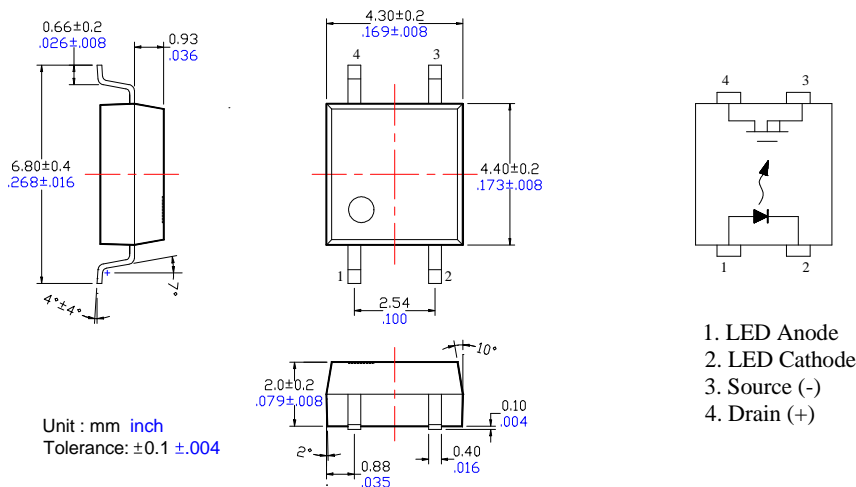

## Photo DMOS-FET Relay Specifications

**Part Name: LT218D**

(Load voltage: 40V / Load current: 3.5A/DC)

Absolute Maximum Ratings (Ambient Temperature: 25°C)

Item	Symbol	Value	Units	Note	
Input	Continuous LED Current	I <sub>F</sub>	50	mA	
	Peak LED Current	I <sub>FP</sub>	1000	mA	f=100Hz, duty=1%
	LED Reverse Voltage	V <sub>R</sub>	5	V	
	Input Power Dissipation	P <sub>In</sub>	75	mW	
Output	Load Voltage	V <sub>L</sub>	40	VDC	
	Load Current	I <sub>L</sub>	3.5	A	
	Peak Load Current	I <sub>Peak</sub>	5.0	A	300 μs(1 pulse)
	Output Power Dissipation	P <sub>out</sub>	400	mW	
Total Power Dissipation	P <sub>T</sub>	600	mW		
I/O Breakdown Voltage	V <sub>I/O</sub>	1500	V <sub>rms</sub>	RH=60%, 1min	
Operating Temperature	T <sub>opr</sub>	-40 to +85	°C		
Storage Temperature	T <sub>stg</sub>	-40 to +100	°C		
Pin Soldering Temperature	T <sub>sol</sub>	260	°C	10 sec max.	

Electrical Specifications (Ambient Temperature: 25°C)

Item	Symbol	MIN.	TYP.	MAX.	Units	Conditions
Input	LED Forward Voltage	V <sub>F</sub>	1.2	1.4	V	I <sub>F</sub> =10mA
	Operation LED Current	I <sub>F on</sub>	0.5	2.0	mA	
	Recovery LED Current	I <sub>F off</sub>	0.3	0.5	mA	
	Recovery LED Voltage	V <sub>F off</sub>	0.7		V	
Output	On-Resistance	R <sub>on</sub>	0.05	0.08	Ω	I <sub>F</sub> =5mA, I <sub>L</sub> =100mA, Time to flow is within 1 sec.
	Off-State Leakage Current	I <sub>Leak</sub>		0.1	uA	V <sub>L</sub> =Rating
	Output Capacitance	C <sub>out</sub>		240	pF	V <sub>L</sub> =0, f=1MHz
Transmission	Turn-On Time	T <sub>on</sub>	0.4	0.8	ms	I <sub>F</sub> =5mA, I <sub>L</sub> =100mA,
	Turn-Off Time	T <sub>off</sub>	0.03	0.05	ms	
Coupled	I/O Isolation Resistance	R <sub>I/O</sub>	10 <sup>10</sup>		Ω	DC500V
	I/O Capacitance	C <sub>I/O</sub>		0.8	1.5	pF

# Reference Data

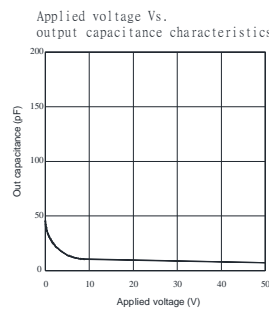
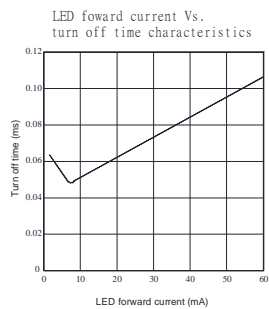
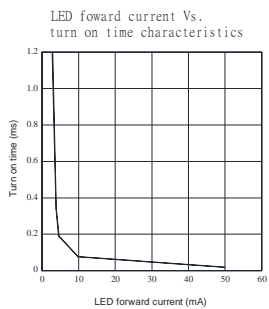
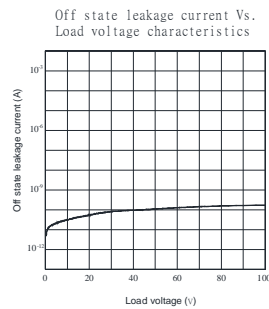
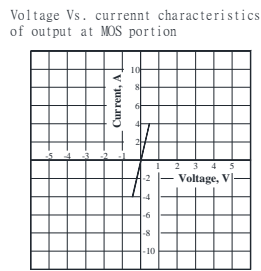
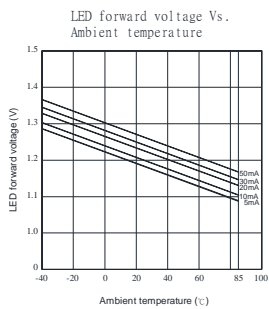
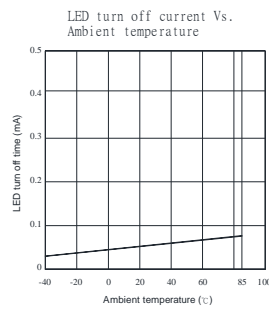
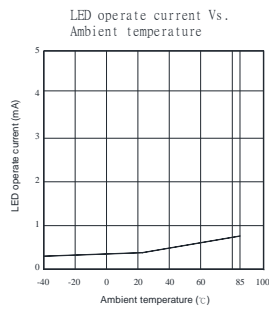
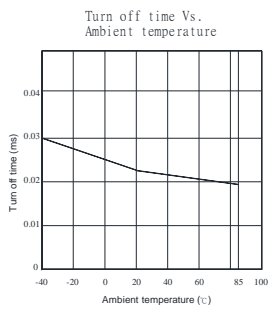
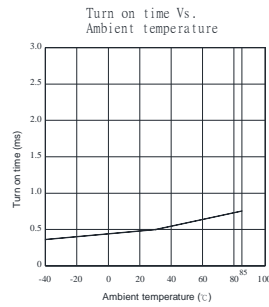
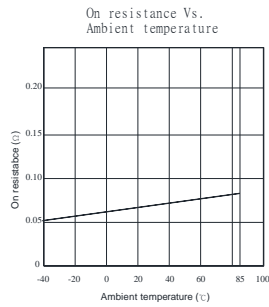
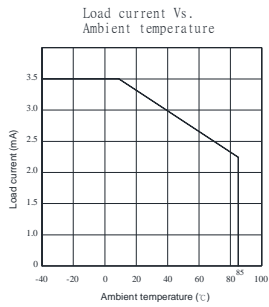

## Taping Specifications for Surface Mount Devices

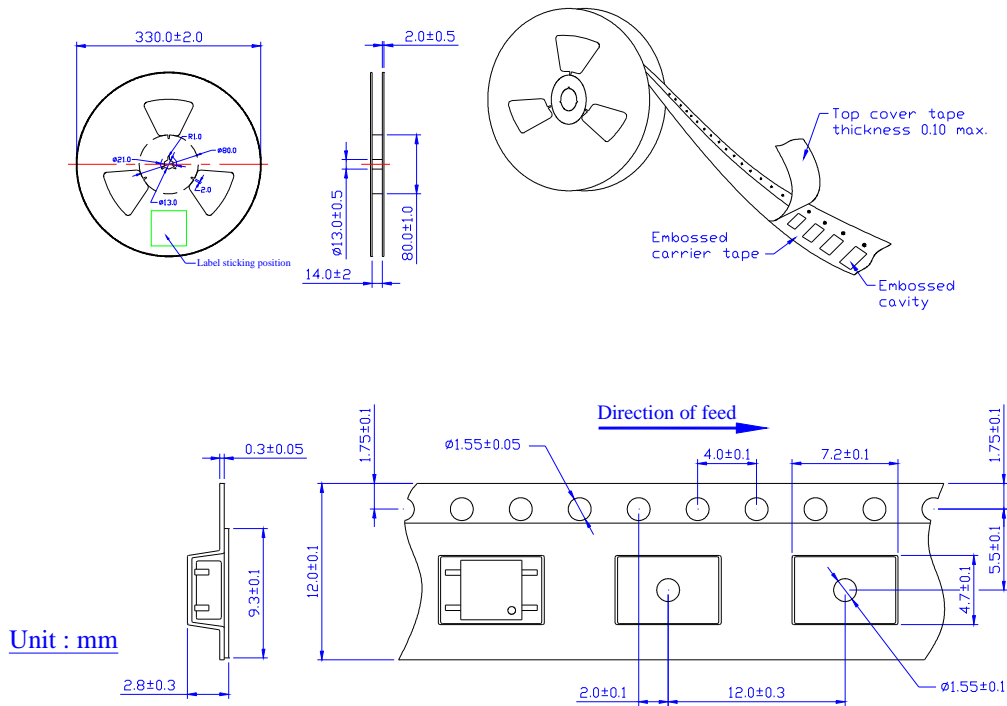

### Recommended Mounting Pad

(Unit: mm / Tolerance: ±0.1)

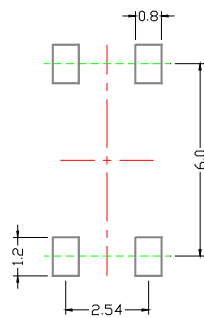

### Marking

(Each photo MOS relay shall be marked with the following information)

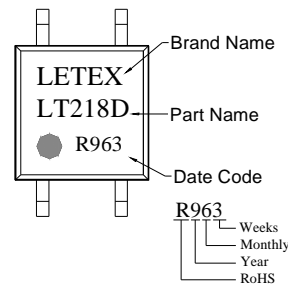

- Note:**
1. There shall be leader of 230 mm minimum which may consist of carrier and or cover tape follower by a minimum of 160 mm of carrier tape sealed with cover tape.
  2. There shall be a minimum of 160 mm of empty component pockets sealed with cover tape.
  3. Devices are pockets in accordance with EIA standard EIA-481-A and specifications given above.
  4. Packaging: 2,000pcs per reel, 2 reel per box, 5 boxes per carton.