

# ESD Protection Diode

## Ultra-Low Capacitance

### Micro-Packaged Diodes for ESD Protection

## ESD7462, SZESD7462

The ESD7462 is designed to protect voltage sensitive components that require ultra-low capacitance from ESD and transient voltage events. It has industry leading capacitance linearity over voltage making it ideal for RF applications. This capacitance linearity combined with the extremely small package and low insertion loss makes this part well suited for use in antenna line applications for wireless handsets and terminals.

### Features

- Industry Leading Capacitance Linearity Over Voltage
- Ultra-Low Capacitance: 0.3 pF Typ
- Insertion Loss: 0.05 dB at 1 GHz; 0.10 dB at 3 GHz
- Low Leakage: < 1 nA Typ
- Protection for the following IEC Standards:
  - ◆ IEC61000-4-2 (ESD): Level 4
  - ◆ IEC61000-4-4 (EFT): 40 A -5/50 ns
  - ◆ IEC61000-4-5 (Lightning): 1 A (8/20  $\mu$ s)
- Protection for ISO 10605 (ESD)
- SZESD7462MXWT5G – Wettable Flank Package for Optimal Automated Optical Inspection (AOI)
- SZ Prefix for Automotive and Other Applications Requiring Unique Site and Control Change Requirements; AEC-Q101 Qualified and PPAP Capable
- These Devices are Pb-Free, Halogen Free/BFR Free and are RoHS Compliant

### Typical Applications

- RF Signal ESD Protection
- RF Switching, PA, and Antenna ESD Protection
- Near Field Communications
- USB 2.0, USB 3.0

### MAXIMUM RATINGS ( $T_A = 25^\circ\text{C}$ unless otherwise noted)

Rating	Symbol	Value	Unit
IEC 61000-4-2 Contact (Note 1)	ESD	$\pm 18$	kV
IEC 61000-4-2 Air		$\pm 18$	
ISO 10605 Contact (330 pF / 330 $\Omega$ )		$\pm 13$	
ISO 10605 Contact (330 pF / 2 k $\Omega$ )		$\pm 29$	
ISO 10605 Contact (150 pF / 2 k $\Omega$ )		$\pm 30$	
Total Power Dissipation (Note 2) @ $T_A = 25^\circ\text{C}$	$P_D$	300	mW
Thermal Resistance, Junction-to-Ambient	$R_{\theta JA}$	400	$^\circ\text{C}/\text{W}$
Junction and Storage Temperature Range	$T_J, T_{stg}$	-55 to +150	$^\circ\text{C}$
Lead Solder Temperature – Maximum (10 Second Duration)	$T_L$	260	$^\circ\text{C}$

Stresses exceeding those listed in the Maximum Ratings table may damage the device. If any of these limits are exceeded, device functionality should not be assumed, damage may occur and reliability may be affected.

1. Non-repetitive current pulse at  $T_A = 25^\circ\text{C}$ , per IEC61000-4-2 waveform.
2. Mounted with recommended minimum pad size, DC board FR-4



ON Semiconductor®

[www.onsemi.com](http://www.onsemi.com)



### MARKING DIAGRAM



X2DFN2  
CASE 714AB

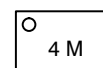

4 = Specific Device Code  
M = Date Code



X2DFNW2  
CASE 711BG



E = Specific Device Code  
M = Date Code

### ORDERING INFORMATION

Device	Package	Shipping†
ESD7462N2T5G	X2DFN2 (Pb-Free)	8000 / Tape & Reel
SZESD7462N2T5G	X2DFN2 (Pb-Free)	8000 / Tape & Reel
SZESD7462MXWT5G	X2DFNW2 (Pb-Free)	8000 / Tape & Reel

†For information on tape and reel specifications, including part orientation and tape sizes, please refer to our Tape and Reel Packaging Specifications Brochure, BRD8011/D.

# ESD7462, SZESD7462

## ELECTRICAL CHARACTERISTICS

( $T_A = 25^\circ\text{C}$  unless otherwise noted)

Symbol	Parameter
$I_{PP}$	Maximum Reverse Peak Pulse Current
$V_C$	Clamping Voltage @ $I_{PP}$
$V_{RWM}$	Working Peak Reverse Voltage
$I_R$	Maximum Reverse Leakage Current @ $V_{RWM}$
$V_{BR}$	Breakdown Voltage @ $I_T$
$I_T$	Test Current

\*See Application Note AND8308/D for detailed explanations of datasheet parameters.



## ELECTRICAL CHARACTERISTICS ( $T_A = 25^\circ\text{C}$ unless otherwise noted)

Parameter	Symbol	Condition	Min	Typ	Max	Unit
Reverse Working Voltage	$V_{RWM}$				16	V
Breakdown Voltage	$V_{BR}$	$I_T = 1 \text{ mA}$ (Note 3)	16.5	22	28	V
Reverse Leakage Current	$I_R$	$V_{RWM} = 5 \text{ V}$			100	nA
Clamping Voltage	$V_C$	IEC 61000-4-2, $\pm 8 \text{ kV}$ Contact	See Figures 1 and 2			V
Clamping Voltage, TLP (Note 4)	$V_C$	$I_{PP} = \pm 8 \text{ A}$ $I_{PP} = \pm 16 \text{ A}$		$\pm 34$ $\pm 47$		V
Dynamic Resistance	$R_{DYN}$	TLP Pulse		1.6		$\Omega$
Junction Capacitance	$C_J$	$V_R = 0 \text{ V}$ , $f = 1 \text{ MHz}$ $V_R = 0 \text{ V}$ , $f = 1 \text{ GHz}$		0.30 0.25	0.55 0.55	pF
Insertion Loss		$f = 1 \text{ GHz}$ $f = 3 \text{ GHz}$		0.05 0.10		dB

Product parametric performance is indicated in the Electrical Characteristics for the listed test conditions, unless otherwise noted. Product performance may not be indicated by the Electrical Characteristics if operated under different conditions.

- Breakdown voltage is tested from pin 1 to 2 and pin 2 to 1.
- ANSI/ESD STM5.5.1 – Electrostatic Discharge Sensitivity Testing using Transmission Line Pulse (TLP) Model.  
TLP conditions:  $Z_0 = 50 \Omega$ ,  $t_p = 100 \text{ ns}$ ,  $t_r = 4 \text{ ns}$ , averaging window;  $t_1 = 30 \text{ ns}$  to  $t_2 = 60 \text{ ns}$ .

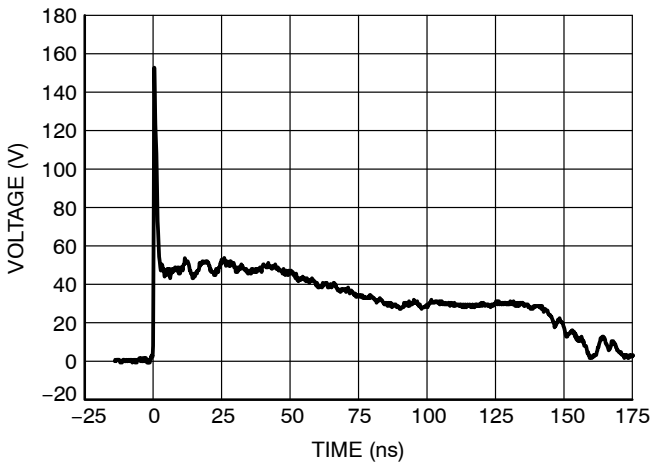

Figure 1. Typical IEC61000-4-2 +8 kV Contact ESD Clamping Voltage

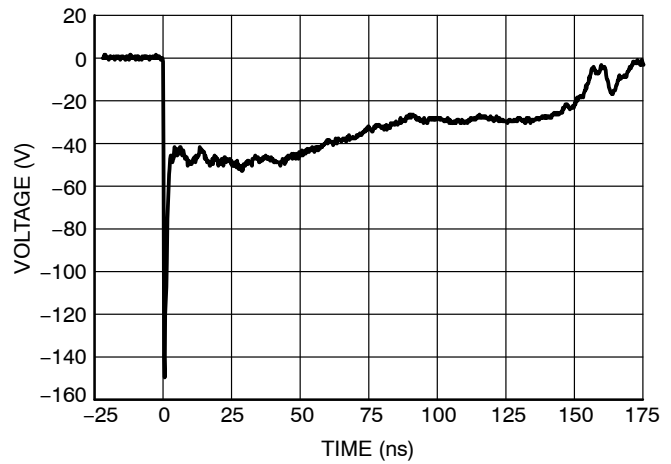

Figure 2. Typical IEC61000-4-2 -8 kV Contact ESD Clamping Voltage

TYPICAL CHARACTERISTICS

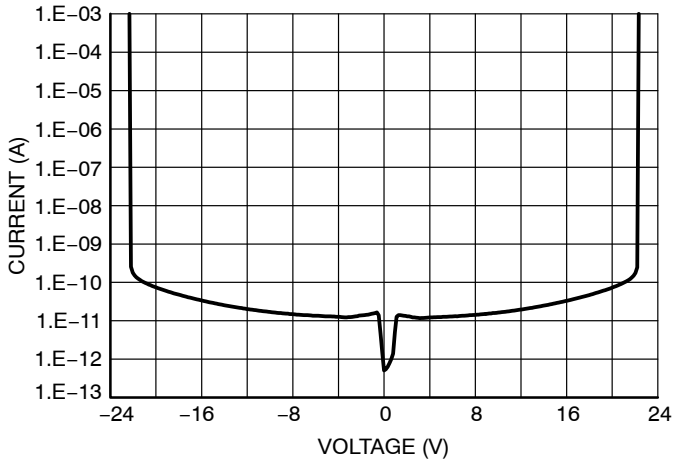

Figure 3. Typical IV Characteristic Curve

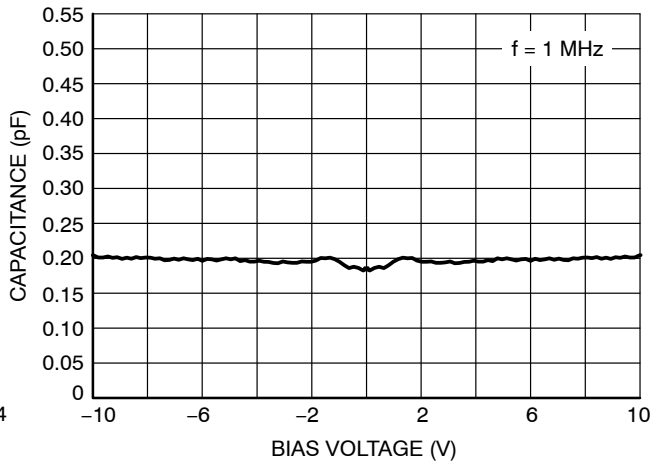

Figure 4. Typical CV Characteristic Curve

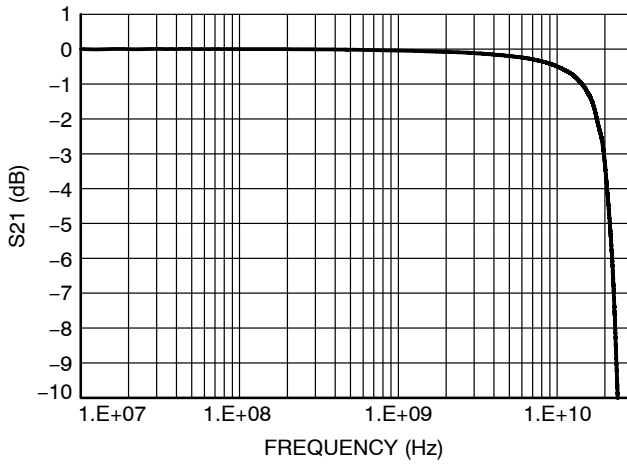

Figure 5. Typical Insertion Loss

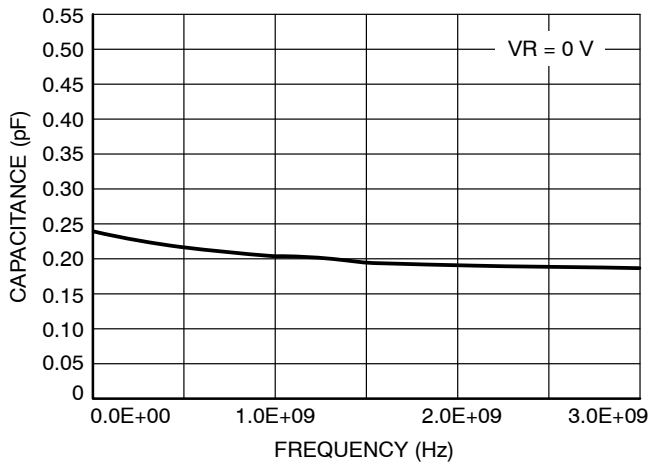

Figure 6. Typical Capacitance Over Frequency

# ESD7462, SZESD7462

IEC 61000-4-2 Spec.

Level	Test Voltage (kV)	First Peak Current (A)	Current at 30 ns (A)	Current at 60 ns (A)
1	2	7.5	4	2
2	4	15	8	4
3	6	22.5	12	6
4	8	30	16	8



Figure 7. IEC61000-4-2 Spec

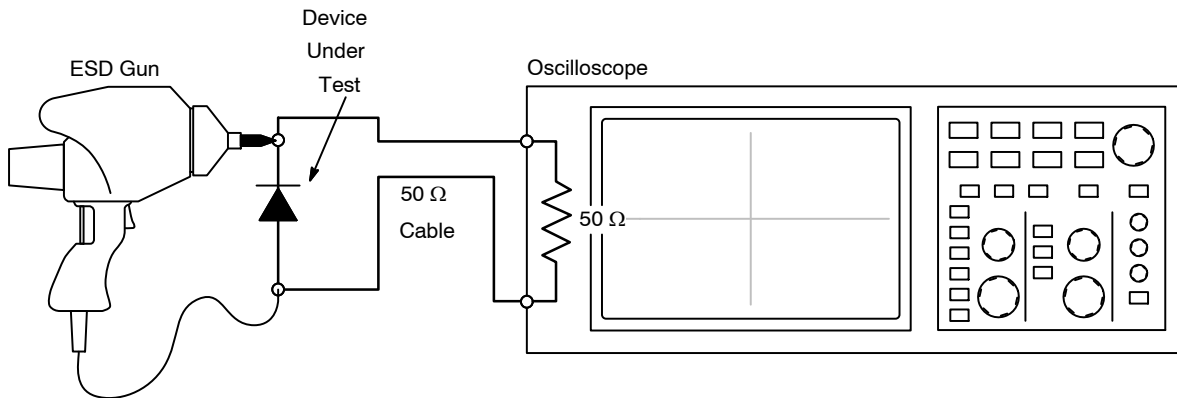

Figure 8. Diagram of ESD Clamping Voltage Test Setup

The following is taken from Application Note AND8308/D – Interpretation of Datasheet Parameters for ESD Devices.

### ESD Voltage Clamping

For sensitive circuit elements it is important to limit the voltage that an IC will be exposed to during an ESD event to as low a voltage as possible. The ESD clamping voltage is the voltage drop across the ESD protection diode during an ESD event per the IEC61000-4-2 waveform. Since the IEC61000-4-2 was written as a pass/fail spec for larger

systems such as cell phones or laptop computers it is not clearly defined in the spec how to specify a clamping voltage at the device level. ON Semiconductor has developed a way to examine the entire voltage waveform across the ESD protection diode over the time domain of an ESD pulse in the form of an oscilloscope screenshot, which can be found on the datasheets for all ESD protection diodes. For more information on how ON Semiconductor creates these screenshots and how to interpret them please refer to AND8307/D.

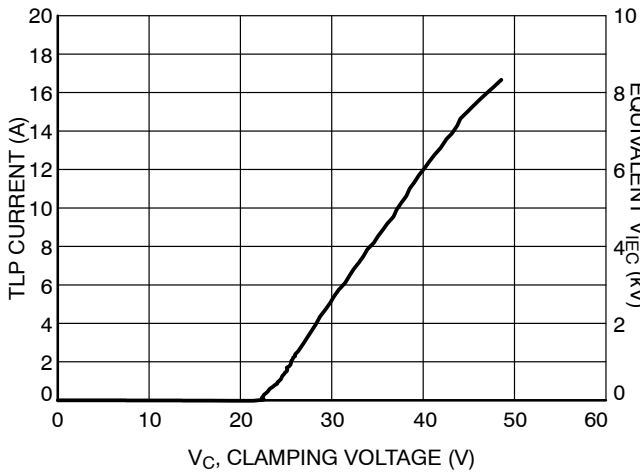

Figure 9. Typical Positive TLP IV Curve

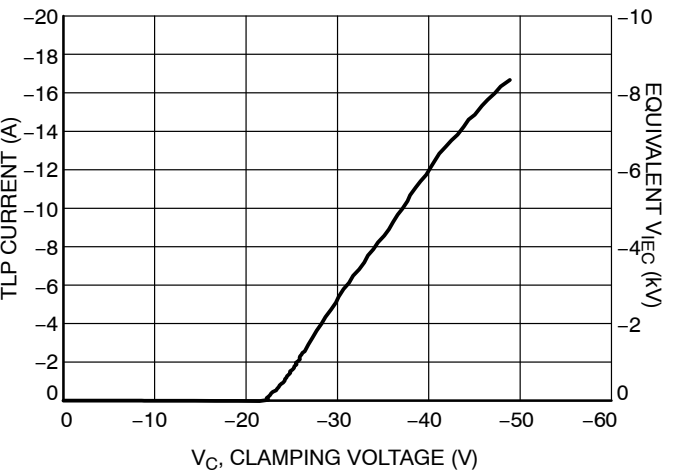

Figure 10. Typical Negative TLP IV Curve

NOTE: TLP parameter:  $Z_0 = 50 \Omega$ ,  $t_p = 100 \text{ ns}$ ,  $t_r = 300 \text{ ps}$ , averaging window:  $t_1 = 30 \text{ ns}$  to  $t_2 = 60 \text{ ns}$ .  $V_{IEC}$  is the equivalent voltage stress level calculated at the secondary peak of the IEC 61000-4-2 waveform at  $t = 30 \text{ ns}$  with  $2 \text{ A/kV}$ . See TLP description below for more information.

**Transmission Line Pulse (TLP) Measurement**

Transmission Line Pulse (TLP) provides current versus voltage (I-V) curves in which each data point is obtained from a 100 ns long rectangular pulse from a charged transmission line. A simplified schematic of a typical TLP system is shown in Figure 11. TLP I-V curves of ESD protection devices accurately demonstrate the product’s ESD capability because the 10s of amps current levels and under 100 ns time scale match those of an ESD event. This is illustrated in Figure 12 where an 8 kV IEC 61000-4-2 current waveform is compared with TLP current pulses at 8 A and 16 A. A TLP I-V curve shows the voltage at which the device turns on as well as how well the device clamps voltage over a range of current levels.

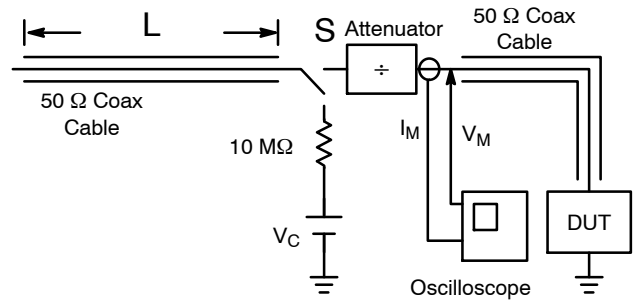

Figure 11. Simplified Schematic of a Typical TLP System

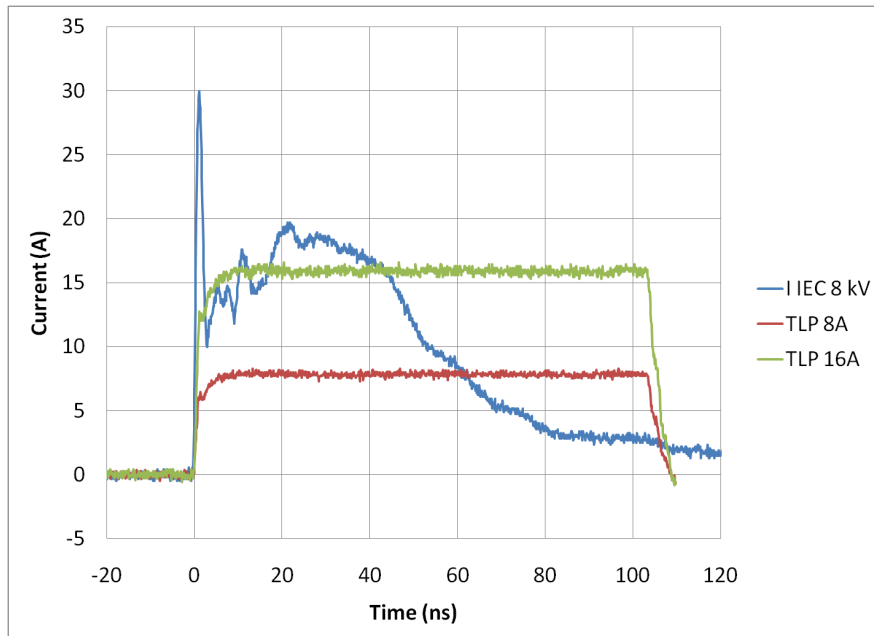

Figure 12. Comparison Between 8 kV IEC 61000-4-2 and 8 A and 16 A TLP Waveforms

# MECHANICAL CASE OUTLINE

## PACKAGE DIMENSIONS

ON Semiconductor®



SCALE 8:1

**X2DFNW2 1.0x0.6, 0.65P**  
**CASE 711BG**  
**ISSUE C**

DATE 13 SEP 2019

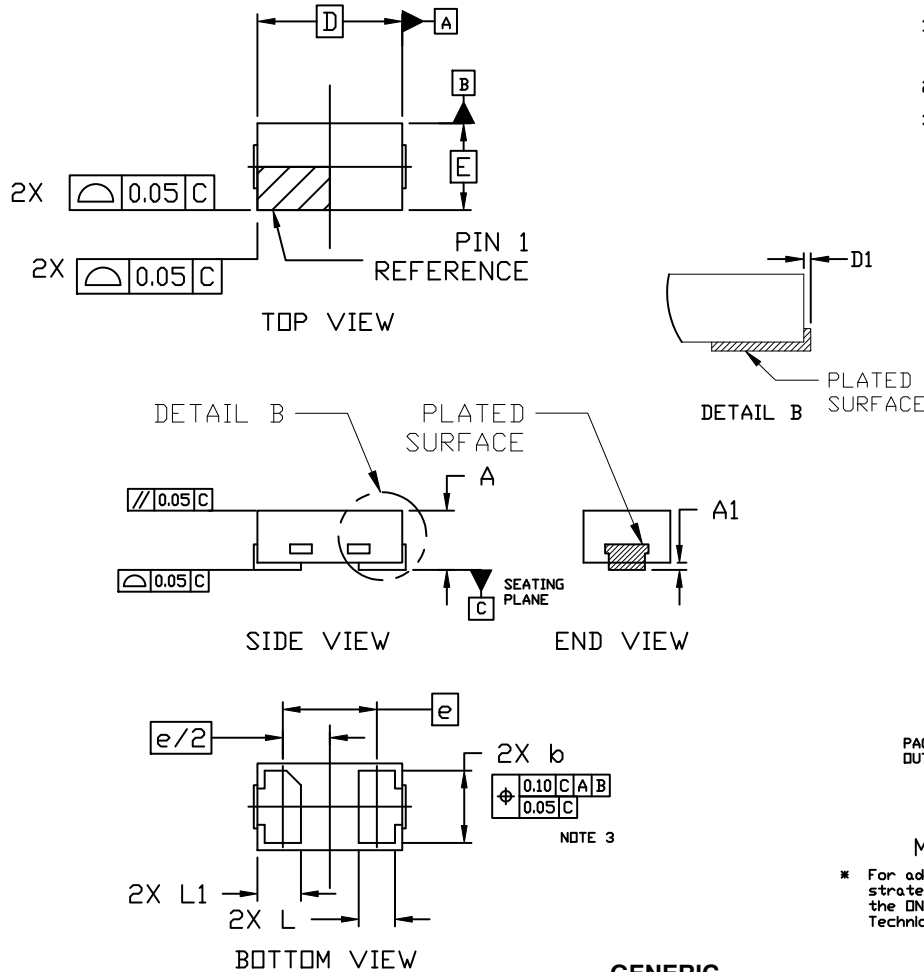

NOTES:

1. DIMENSIONING AND TOLERANCING PER ASME Y14.5M, 2009.
2. CONTROLLING DIMENSION: MILLIMETERS
3. DIMENSION *b* APPLIES TO THE PLATED TERMINAL AND IS MEASURED BETWEEN 0.15 AND 0.30 FROM THE TERMINAL TIP.

DIM	MILLIMETERS		
	MIN.	NDM.	MAX.
A	0.34	0.37	0.40
A1	---	---	0.05
<i>b</i>	0.45	0.50	0.55
D	0.90	1.00	1.10
D1	---	---	0.05
E	0.50	0.60	0.70
<i>e</i>	0.65 BSC		
L	0.22 REF		
L1	0.24	0.285	0.34

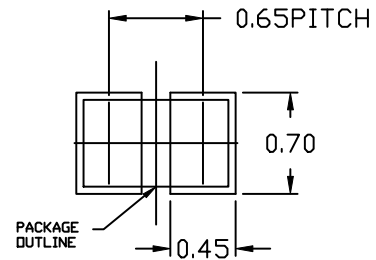

RECOMMENDED MOUNTING FOOTPRINT

\* For additional information on our Pb-Free strategy and soldering details, please download the ON Semiconductor Soldering and Mounting Techniques Reference Manual, SOLDERM/D.

GENERIC MARKING DIAGRAM\*



XX = Specific Device Code  
M = Date Code

\*This information is generic. Please refer to device data sheet for actual part marking. Pb-Free indicator, "G", may or not be present. Some products may not follow the Generic Marking.

<b>DOCUMENT NUMBER:</b>	<b>98AON15241G</b>	Electronic versions are uncontrolled except when accessed directly from the Document Repository. Printed versions are uncontrolled except when stamped "CONTROLLED COPY" in red.
<b>DESCRIPTION:</b>	<b>X2DFNW2 1.0X0.6, 0.65P</b>	<b>PAGE 1 OF 1</b>

ON Semiconductor and are trademarks of Semiconductor Components Industries, LLC dba ON Semiconductor or its subsidiaries in the United States and/or other countries. ON Semiconductor reserves the right to make changes without further notice to any products herein. ON Semiconductor makes no warranty, representation or guarantee regarding the suitability of its products for any particular purpose, nor does ON Semiconductor assume any liability arising out of the application or use of any product or circuit, and specifically disclaims any and all liability, including without limitation special, consequential or incidental damages. ON Semiconductor does not convey any license under its patent rights nor the rights of others.

# MECHANICAL CASE OUTLINE

## PACKAGE DIMENSIONS

ON Semiconductor®



SCALE 8:1

X2DFN2 1.0x0.6, 0.65P  
CASE 714AB  
ISSUE B

DATE 21 NOV 2017

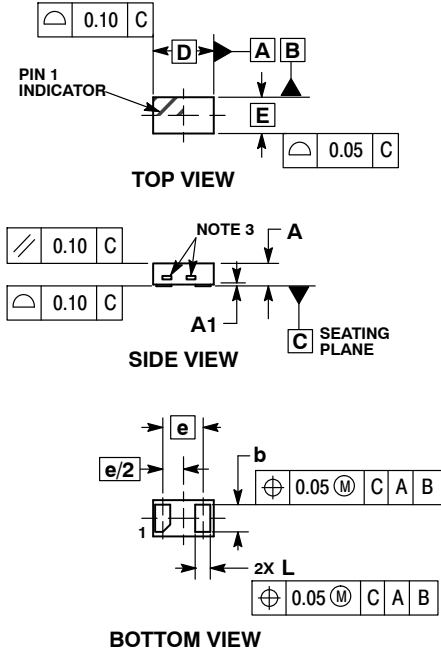

- NOTES:
1. DIMENSIONING AND TOLERANCING PER ASME Y14.5M, 1994.
  2. CONTROLLING DIMENSION: MILLIMETERS.
  3. EXPOSED COPPER ALLOWED AS SHOWN.

DIM	MILLIMETERS		
	MIN	NOM	MAX
A	0.34	0.37	0.40
A1	---	0.03	0.05
b	0.45	0.50	0.55
D	0.95	1.00	1.05
E	0.55	0.60	0.65
e	0.65 BSC		
L	0.20	0.25	0.30

**GENERIC MARKING DIAGRAM\***

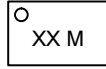

XX = Specific Device Code  
M = Date Code

**RECOMMENDED SOLDER FOOTPRINT\***

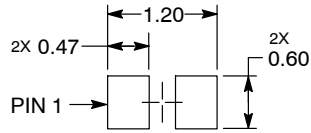

DIMENSIONS: MILLIMETERS

\*This information is generic. Please refer to device data sheet for actual part marking. Pb-Free indicator, "G" or microdot "▪", may or may not be present. Some products may not follow the Generic Marking.

<b>DOCUMENT NUMBER:</b>	<b>98AON98172F</b>	Electronic versions are uncontrolled except when accessed directly from the Document Repository. Printed versions are uncontrolled except when stamped "CONTROLLED COPY" in red.
<b>DESCRIPTION:</b>	<b>X2DFN2 1.0X0.6, 0.65P</b>	<b>PAGE 1 OF 1</b>

ON Semiconductor and are trademarks of Semiconductor Components Industries, LLC dba ON Semiconductor or its subsidiaries in the United States and/or other countries. ON Semiconductor reserves the right to make changes without further notice to any products herein. ON Semiconductor makes no warranty, representation or guarantee regarding the suitability of its products for any particular purpose, nor does ON Semiconductor assume any liability arising out of the application or use of any product or circuit, and specifically disclaims any and all liability, including without limitation special, consequential or incidental damages. ON Semiconductor does not convey any license under its patent rights nor the rights of others.

ON Semiconductor and  are trademarks of Semiconductor Components Industries, LLC dba ON Semiconductor or its subsidiaries in the United States and/or other countries. ON Semiconductor owns the rights to a number of patents, trademarks, copyrights, trade secrets, and other intellectual property. A listing of ON Semiconductor's product/patent coverage may be accessed at [www.onsemi.com/site/pdf/Patent-Marking.pdf](http://www.onsemi.com/site/pdf/Patent-Marking.pdf). ON Semiconductor reserves the right to make changes without further notice to any products herein. ON Semiconductor makes no warranty, representation or guarantee regarding the suitability of its products for any particular purpose, nor does ON Semiconductor assume any liability arising out of the application or use of any product or circuit, and specifically disclaims any and all liability, including without limitation special, consequential or incidental damages. Buyer is responsible for its products and applications using ON Semiconductor products, including compliance with all laws, regulations and safety requirements or standards, regardless of any support or applications information provided by ON Semiconductor. "Typical" parameters which may be provided in ON Semiconductor data sheets and/or specifications can and do vary in different applications and actual performance may vary over time. All operating parameters, including "Typicals" must be validated for each customer application by customer's technical experts. ON Semiconductor does not convey any license under its patent rights nor the rights of others. ON Semiconductor products are not designed, intended, or authorized for use as a critical component in life support systems or any FDA Class 3 medical devices or medical devices with a same or similar classification in a foreign jurisdiction or any devices intended for implantation in the human body. Should Buyer purchase or use ON Semiconductor products for any such unintended or unauthorized application, Buyer shall indemnify and hold ON Semiconductor and its officers, employees, subsidiaries, affiliates, and distributors harmless against all claims, costs, damages, and expenses, and reasonable attorney fees arising out of, directly or indirectly, any claim of personal injury or death associated with such unintended or unauthorized use, even if such claim alleges that ON Semiconductor was negligent regarding the design or manufacture of the part. ON Semiconductor is an Equal Opportunity/Affirmative Action Employer. This literature is subject to all applicable copyright laws and is not for resale in any manner.

## PUBLICATION ORDERING INFORMATION

### LITERATURE FULFILLMENT:

Email Requests to: [orderlit@onsemi.com](mailto:orderlit@onsemi.com)

ON Semiconductor Website: [www.onsemi.com](http://www.onsemi.com)

### TECHNICAL SUPPORT

North American Technical Support:  
Voice Mail: 1 800-282-9855 Toll Free USA/Canada  
Phone: 011 421 33 790 2910

### Europe, Middle East and Africa Technical Support:

Phone: 00421 33 790 2910

For additional information, please contact your local Sales Representative