

# 1SMA59xxBT3G Series, SZ1SMA59xxBT3G Series

## 1.5 Watt Plastic Surface Mount Zener Voltage Regulators

This complete new line of 1.5 Watt Zener Diodes offers the following advantages.

### Features

- Standard Zener Breakdown Voltage Range – 3.3 V to 68 V
- ESD Rating of Class 3 (> 16 kV) per Human Body Model
- Flat Handling Surface for Accurate Placement
- Package Design for Top Slide or Bottom Circuit Board Mounting
- Low Profile Package
- Ideal Replacement for MELF Packages
- AEC-Q101 Qualified and PPAP Capable – SZ1SMA59xxBT3G
- SZ Prefix for Automotive and Other Applications Requiring Unique Site and Control Change Requirements
- These are Pb-Free Devices\*

### Mechanical Characteristics:

**CASE:** Void-free, transfer-molded plastic

**FINISH:** All external surfaces are corrosion resistant with readily solderable leads

**MAXIMUM CASE TEMPERATURE FOR SOLDERING PURPOSES:**  
260°C for 10 seconds

**POLARITY:** Cathode indicated by molded polarity notch or cathode band

**FLAMMABILITY RATING:** UL 94 V-0 @ 0.125 in

### MAXIMUM RATINGS

Rating	Symbol	Value	Unit
DC Power Dissipation @ $T_L = 75^\circ\text{C}$ , Measured Zero Lead Length (Note 1) Derate above $75^\circ\text{C}$	$P_D$	1.5 20	W mW/ $^\circ\text{C}$
Thermal Resistance, Junction-to-Lead	$R_{\theta JL}$	50	$^\circ\text{C}/\text{W}$
DC Power Dissipation @ $T_A = 25^\circ\text{C}$ (Note 2) Derate above $25^\circ\text{C}$	$P_D$	0.5 4.0	W mW/ $^\circ\text{C}$
Thermal Resistance, Junction-to-Ambient	$R_{\theta JA}$	250	$^\circ\text{C}/\text{W}$
Operating and Storage Temperature Range	$T_J, T_{stg}$	-65 to +150	$^\circ\text{C}$

Stresses exceeding those listed in the Maximum Ratings table may damage the device. If any of these limits are exceeded, device functionality should not be assumed, damage may occur and reliability may be affected.

1. 1 in square copper pad, FR-4 board.
2. FR-4 Board, using ON Semiconductor minimum recommended footprint.

\*For additional information on our Pb-Free strategy and soldering details, please download the ON Semiconductor Soldering and Mounting Techniques Reference Manual, SOLDERRM/D.



ON Semiconductor®

[www.onsemi.com](http://www.onsemi.com)



SMA  
CASE 403D  
STYLE 1

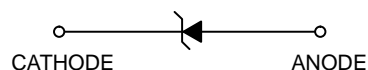

### MARKING DIAGRAM



- 8xxB = Device Code (Refer to page 2)
- A = Assembly Location
- Y = Year
- WW = Work Week
- = Pb-Free Package

### ORDERING INFORMATION

Device	Package	Shipping†
1SMA59xxBT3G	SMA (Pb-Free)	5,000 / Tape & Reel
SZ1SMA59xxBT3G	SMA (Pb-Free)	5,000 / Tape & Reel

†For information on tape and reel specifications, including part orientation and tape sizes, please refer to our Tape and Reel Packaging Specifications Brochure, BRD8011/D.

### DEVICE MARKING INFORMATION

See specific marking information in the device marking column of the Electrical Characteristics table on page 2 of this data sheet.

# 1SMA59xxBT3G Series, SZ1SMA59xxBT3G Series

**ELECTRICAL CHARACTERISTICS** ( $T_A = 25^\circ\text{C}$  unless otherwise noted,  $V_F = 1.2\text{ V Max.}$  @  $I_F = 200\text{ mA}$  for all types)

Symbol	Parameter
$V_Z$	Reverse Zener Voltage @ $I_{ZT}$
$I_{ZT}$	Reverse Current
$Z_{ZT}$	Maximum Zener Impedance @ $I_{ZT}$
$I_{ZK}$	Reverse Current
$Z_{ZK}$	Maximum Zener Impedance @ $I_{ZK}$
$I_R$	Reverse Leakage Current @ $V_R$
$V_R$	Reverse Voltage
$I_F$	Forward Current
$V_F$	Forward Voltage @ $I_F$
$I_{ZM}$	Maximum DC Zener Current

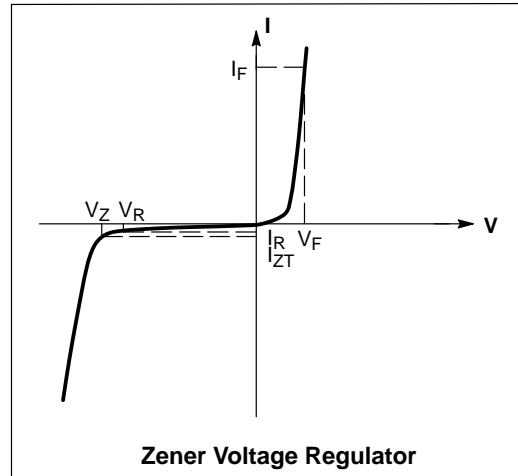

**ELECTRICAL CHARACTERISTICS** ( $T_A = 25^\circ\text{C}$  unless otherwise noted,  $V_F = 1.2\text{ V Max.}$  @  $I_F = 200\text{ mA}$  for all types)

Device* (Note 3)	Device Marking	Zener Voltage (Note 4)				Zener Impedance			Leakage Current		$I_{ZM}$
		$V_Z$ (Volts)			@ $I_{ZT}$	$Z_{ZT}$ @ $I_{ZT}$	$Z_{ZK}$ @ $I_{ZK}$	$I_R$ @ $V_R$			
		Min	Nom	Max	mA	$\Omega$	$\Omega$	mA	$\mu\text{A}$	Volts	
1SMA5913BT3G	813B	3.13	3.3	3.47	113.6	10	500	1.0	50	1.0	455
1SMA5914BT3G	814B	3.42	3.6	3.78	104.2	9.0	500	1.0	35.5	1.0	417
1SMA5915BT3G	815B	3.70	3.9	4.10	96.1	7.5	500	1.0	12.5	1.0	385
1SMA5916BT3G	816B	4.08	4.3	4.52	87.2	6.0	500	1.0	2.5	1.0	349
1SMA5917BT3G	817B	4.46	4.7	4.94	79.8	5.0	500	1.0	2.5	1.5	319
1SMA5918BT3G	818B	4.84	5.1	5.36	73.5	4.0	350	1.0	2.5	2.0	294
1SMA5919BT3G	819B	5.32	5.6	5.88	66.9	2.0	250	1.0	2.5	3.0	268
1SMA5920BT3G	820B	5.89	6.2	6.51	60.5	2.0	200	1.0	2.5	4.0	242
1SMA5921BT3G	821B	6.46	6.8	7.14	55.1	2.5	200	1.0	2.5	5.2	221
1SMA5922BT3G	822B	7.12	7.5	7.88	50	3.0	400	0.5	2.5	6.0	200
1SMA5923BT3G	823B	7.79	8.2	8.61	45.7	3.5	400	0.5	2.5	6.5	183
1SMA5924BT3G	824B	8.64	9.1	9.56	41.2	4.0	500	0.5	2.5	7.0	165
1SMA5925BT3G	825B	9.5	10	10.5	37.5	4.5	500	0.25	2.5	8.0	150
1SMA5926BT3G	826B	10.45	11	11.55	34.1	5.5	550	0.25	0.5	8.4	136
1SMA5927BT3G	827B	11.4	12	12.6	31.2	6.5	550	0.25	0.5	9.1	125
1SMA5928BT3G	828B	12.35	13	13.65	28.8	7.0	550	0.25	0.5	9.9	115
1SMA5929BT3G	829B	14.25	15	15.75	25	9.0	600	0.25	0.5	11.4	100
1SMA5930BT3G	830B	15.2	16	16.8	23.4	10	600	0.25	0.5	12.2	94
1SMA5931BT3G	831B	17.1	18	18.9	20.8	12	650	0.25	0.5	13.7	83
1SMA5932BT3G	832B	19	20	21	18.7	14	650	0.25	0.5	15.2	75
1SMA5933BT3G	833B	20.9	22	23.1	17	17.5	650	0.25	0.5	16.7	68
1SMA5934BT3G	834B	22.8	24	25.2	15.6	19	700	0.25	0.5	18.2	63
1SMA5935BT3G	835B	25.65	27	28.35	13.9	23	700	0.25	0.5	20.6	56
1SMA5936BT3G	836B	28.5	30	31.5	12.5	26	750	0.25	0.5	22.8	50
1SMA5937BT3G	837B	31.35	33	34.65	11.4	33	800	0.25	0.5	25.1	45
1SMA5938BT3G	838B	34.2	36	37.8	10.4	38	850	0.25	0.5	27.4	42
1SMA5939BT3G	839B	37.05	39	40.95	9.6	45	900	0.25	0.5	29.7	38
1SMA5940BT3G	840B	40.85	43	45.15	8.7	53	950	0.25	0.5	32.7	35
1SMA5941BT3G	841B	44.65	47	49.35	8.0	67	1000	0.25	0.5	35.8	32
1SMA5942BT3G	842B	48.45	51	53.55	7.3	70	1100	0.25	0.5	38.8	29
1SMA5943BT3G	843B	53.2	56	58.8	6.7	86	1300	0.25	0.5	42.6	27
1SMA5945BT3G	845B	64.6	68	71.4	5.5	120	1700	0.25	0.5	51.7	22

3. Tolerance and Voltage Regulation Designation – The type number listed indicates a tolerance of  $\pm 5\%$ .

4.  $V_Z$  limits are to be guaranteed at thermal equilibrium.

\* Include SZ-prefix devices where applicable.

# 1SMA59xxBT3G Series, SZ1SMA59xxBT3G Series

## RATING AND TYPICAL CHARACTERISTIC CURVES ( $T_A = 25^\circ\text{C}$ )



Figure 1. Steady State Power Derating



Figure 2.  $V_Z - 3.3$  thru 10 Volts



Figure 3.  $V_Z = 12$  thru 68 Volts



Figure 4. Zener Voltage - 3.3 to 12 Volts



Figure 5. Zener Voltage - 12 to 68 Volts



Figure 6. Effect of Zener Voltage

# 1SMA59xxBT3G Series, SZ1SMA59xxBT3G Series

## RATING AND TYPICAL CHARACTERISTIC CURVES ( $T_A = 25^\circ\text{C}$ )



Figure 7. Capacitance Curve

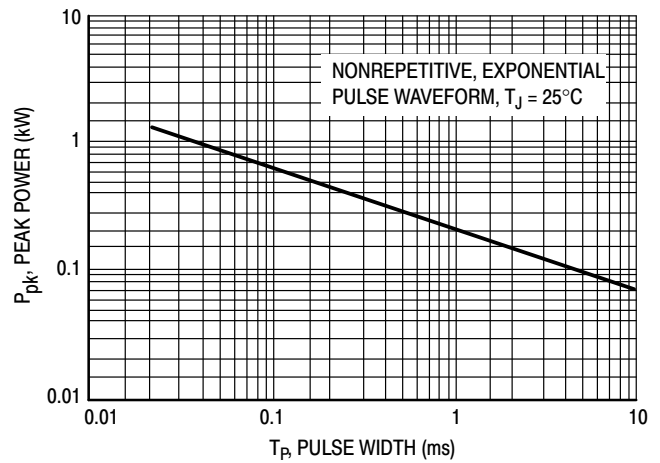

Figure 8. Typical Pulse Rating Curve



Figure 9. Pulse Waveform

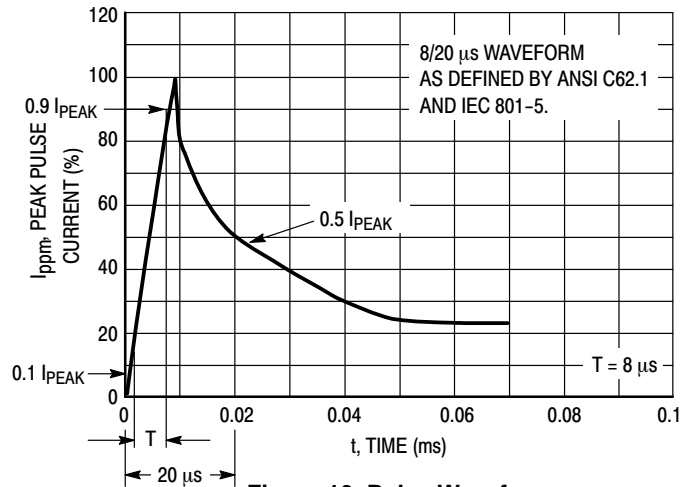

Figure 10. Pulse Waveform

# MECHANICAL CASE OUTLINE

## PACKAGE DIMENSIONS

ON Semiconductor®



STYLE 1    STYLE 2  
SCALE 1:1

### SMA CASE 403D ISSUE H

DATE 23 SEP 2015

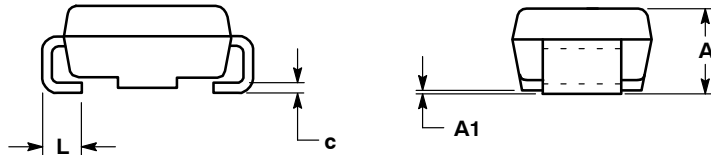
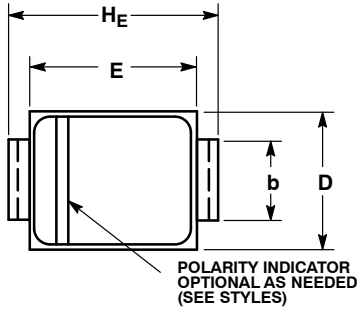

#### SOLDERING FOOTPRINT\*

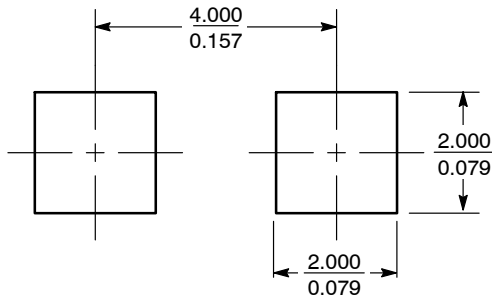

SCALE 8:1 (mm/inches)

\*For additional information on our Pb-Free strategy and soldering details, please download the ON Semiconductor Soldering and Mounting Techniques Reference Manual, SOLDERRM/D.

- NOTES:
1. DIMENSIONING AND TOLERANCING PER ANSI Y14.5M, 1982.
  2. CONTROLLING DIMENSION: INCH.
  3. DIMENSION b SHALL BE MEASURED WITHIN DIMENSION L.

DIM	MILLIMETERS			INCHES		
	MIN	NOM	MAX	MIN	NOM	MAX
A	1.97	2.10	2.20	0.078	0.083	0.087
A1	0.05	0.10	0.20	0.002	0.004	0.008
b	1.27	1.45	1.63	0.050	0.057	0.064
c	0.15	0.28	0.41	0.006	0.011	0.016
D	2.29	2.60	2.92	0.090	0.103	0.115
E	4.06	4.32	4.57	0.160	0.170	0.180
HE	4.83	5.21	5.59	0.190	0.205	0.220
L	0.76	1.14	1.52	0.030	0.045	0.060

#### GENERIC MARKING DIAGRAM\*

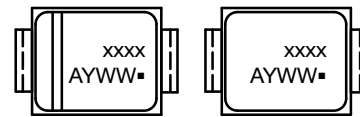

STYLE 1    STYLE 2

- xxxx = Specific Device Code
- A = Assembly Location
- Y = Year
- WW = Work Week
- = Pb-Free Package

\*This information is generic. Please refer to device data sheet for actual part marking. Pb-Free indicator, "G" or microdot "▪", may or may not be present.

- STYLE 1:    STYLE 2:
1. CATHODE (POLARITY BAND)
  2. ANODE
- NO POLARITY

<b>DOCUMENT NUMBER:</b>	<b>98AON04079D</b>	Electronic versions are uncontrolled except when accessed directly from the Document Repository. Printed versions are uncontrolled except when stamped "CONTROLLED COPY" in red.
<b>DESCRIPTION:</b>	<b>SMA</b>	<b>PAGE 1 OF 1</b>

ON Semiconductor and ON are trademarks of Semiconductor Components Industries, LLC dba ON Semiconductor or its subsidiaries in the United States and/or other countries. ON Semiconductor reserves the right to make changes without further notice to any products herein. ON Semiconductor makes no warranty, representation or guarantee regarding the suitability of its products for any particular purpose, nor does ON Semiconductor assume any liability arising out of the application or use of any product or circuit, and specifically disclaims any and all liability, including without limitation special, consequential or incidental damages. ON Semiconductor does not convey any license under its patent rights nor the rights of others.

ON Semiconductor and  are trademarks of Semiconductor Components Industries, LLC dba ON Semiconductor or its subsidiaries in the United States and/or other countries. ON Semiconductor owns the rights to a number of patents, trademarks, copyrights, trade secrets, and other intellectual property. A listing of ON Semiconductor's product/patent coverage may be accessed at [www.onsemi.com/site/pdf/Patent-Marking.pdf](http://www.onsemi.com/site/pdf/Patent-Marking.pdf). ON Semiconductor reserves the right to make changes without further notice to any products herein. ON Semiconductor makes no warranty, representation or guarantee regarding the suitability of its products for any particular purpose, nor does ON Semiconductor assume any liability arising out of the application or use of any product or circuit, and specifically disclaims any and all liability, including without limitation special, consequential or incidental damages. Buyer is responsible for its products and applications using ON Semiconductor products, including compliance with all laws, regulations and safety requirements or standards, regardless of any support or applications information provided by ON Semiconductor. "Typical" parameters which may be provided in ON Semiconductor data sheets and/or specifications can and do vary in different applications and actual performance may vary over time. All operating parameters, including "Typicals" must be validated for each customer application by customer's technical experts. ON Semiconductor does not convey any license under its patent rights nor the rights of others. ON Semiconductor products are not designed, intended, or authorized for use as a critical component in life support systems or any FDA Class 3 medical devices or medical devices with a same or similar classification in a foreign jurisdiction or any devices intended for implantation in the human body. Should Buyer purchase or use ON Semiconductor products for any such unintended or unauthorized application, Buyer shall indemnify and hold ON Semiconductor and its officers, employees, subsidiaries, affiliates, and distributors harmless against all claims, costs, damages, and expenses, and reasonable attorney fees arising out of, directly or indirectly, any claim of personal injury or death associated with such unintended or unauthorized use, even if such claim alleges that ON Semiconductor was negligent regarding the design or manufacture of the part. ON Semiconductor is an Equal Opportunity/Affirmative Action Employer. This literature is subject to all applicable copyright laws and is not for resale in any manner.

## PUBLICATION ORDERING INFORMATION

### LITERATURE FULFILLMENT:

Email Requests to: [orderlit@onsemi.com](mailto:orderlit@onsemi.com)

ON Semiconductor Website: [www.onsemi.com](http://www.onsemi.com)

### TECHNICAL SUPPORT

North American Technical Support:  
Voice Mail: 1 800-282-9855 Toll Free USA/Canada  
Phone: 011 421 33 790 2910

Europe, Middle East and Africa Technical Support:

Phone: 00421 33 790 2910

For additional information, please contact your local Sales Representative