

# Advanced Load Management Switch

## FPF1504 / FPF1504L

### Description

The FPF1504/FPF1504L are low- $R_{DS}$  P-channel MOSFET load switches of the IntelliMAX™ family. Integrated slew-rate control prevents excessive inrush current from the supply rails with capacitive loads common in power applications. In addition, the FPF1504/FPF1504L feature output discharge capability.

The input voltage range operates from 1.0 V to 3.6 V to fulfill today's mobile device supply requirements. Switch control is by a logic input (ON pin) capable of interfacing directly with low-voltage CMOS control signals and GPIOs in embedded processors.

### Features

- 1.0 V to 3.6 V Input Voltage Operating Range
- Typical  $R_{DS(ON)}$ :
  - ◆ 15 m $\Omega$  at  $V_{IN} = 3.3$  V
  - ◆ 20 m $\Omega$  at  $V_{IN} = 1.8$  V
  - ◆ 40 m $\Omega$  at  $V_{IN} = 1.0$  V
- Slew Rate Control
- Output Discharge Function
- Low  $<1$   $\mu$ A Quiescent Current at  $V_{ON} = V_{IN}$
- ESD Protected: 4000 V HBM, 2000 V CDM
- GPIO/CMOS-Compatible Enable Circuitry
- Active HIGH and active LOW versions

### Applications

- Mobile Devices and Smart Phones
- Portable Media Devices
- Digital Cameras
- Advanced Notebook, UMPC, and MID
- Portable Medical Devices
- GPS and Navigation Equipment

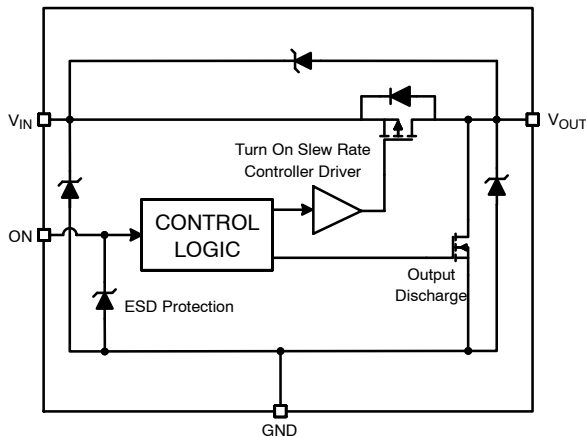

Figure 1. Block Diagram



ON Semiconductor®

[www.onsemi.com](http://www.onsemi.com)



WLCSP4  
CASE 567RH

### MARKING DIAGRAM

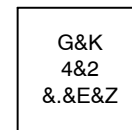

- G = 1<sup>st</sup> Digit of 2 Digit Device ID Mark
- &K = 2-Digits Lot Run Traceability Code
- 4 = 2<sup>nd</sup> Digit of 2 Digit Device ID Mark
- &2 = 2-digit Date Code Format
- &. = Pin 1 Identifier
- &E = Space Designator
- &Z = Assembly Plant Code

### ORDERING INFORMATION

See detailed ordering and shipping information in the package dimensions section on page 2 of this data sheet.

# FPF1504 / FPF1504L

## ORDERING INFORMATION

Part Number	Top Mark	Switch (Typical) At 1.8 V <sub>IN</sub>	Input Buffer	Output Discharge	ON Pin Activity	Package
FPF1504UCX	G4	20 mΩ	CMOS	YES	Active HIGH	4-Ball, WLCSP, 0.5 mm Pitch
FPF1504BUCX	G4	20 mΩ	CMOS	YES	Active HIGH	4-Ball, WLCSP with Backside Laminate, 0.5 mm Pitch
FPF1504LUCX	GZ	20 mΩ	CMOS	YES	Active LOW	4-Ball, WLCSP, 0.5 mm Pitch
FPF1504LBUCX	GZ	20 mΩ	CMOS	YES	Active LOW	4-Ball, WLCSP with Backside Laminate, 0.5 mm Pitch

## Application Diagram

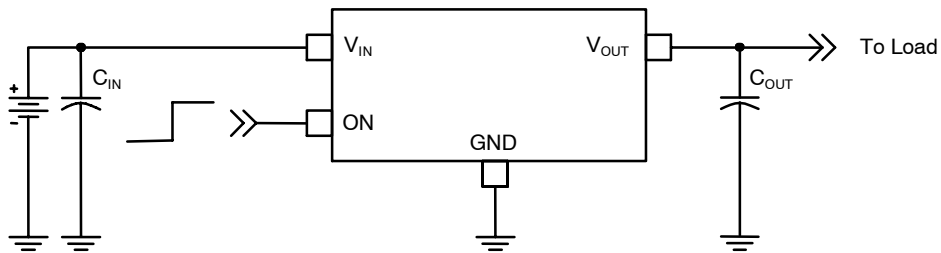

- NOTES: 1. C<sub>IN</sub> = 1 μF, X5R, 0603, for example Murata GRM185R60J105KE26.  
2. C<sub>OUT</sub> = 1 μF, X5R, 0805, for example Murata GRM216R61A105KA01.

Figure 2. Typical Application

## Pin Configurations

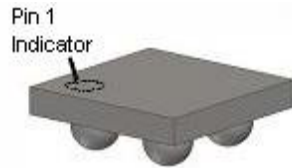

Figure 3. 1 x 1 mm WLCSP Bumps Facing Down

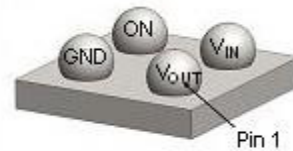

Figure 4. 1 x 1 mm WLCSP Bumps Facing Up

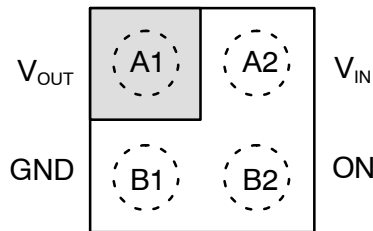

Figure 5. Pin Assignments (Top View)

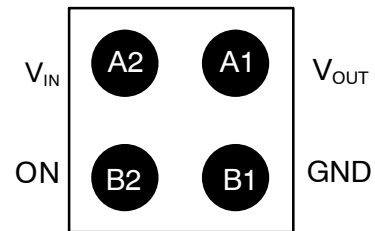

Figure 6. Pin Assignments (Bottom View)

## FPF1504 / FPF1504L

### PIN DEFINITIONS

Pin #	Name	Description
A1	V <sub>OUT</sub>	Switch Output
A2	V <sub>IN</sub>	Supply Input; Input to the Power Switch
B1	GND	Ground
B2	ON	ON/OFF Control

### ABSOLUTE MAXIMUM RATINGS

Symbol	Parameter	Min.	Max.	Unit
V <sub>IN</sub>	V <sub>IN</sub> , V <sub>OUT</sub> , V <sub>ON</sub> to GND	-0.3	4.0	V
I <sub>SW</sub>	Maximum Continuous Switch Current		1.5	A
P <sub>D</sub>	Power Dissipation at T <sub>A</sub> = 25°C		1.0	W
T <sub>STG</sub>	Storage Junction Temperature	-65	+150	°C
T <sub>A</sub>	Operating Temperature Range	-40	+85	°C
θ <sub>JA</sub>	Thermal Resistance, Junction-to-Ambient	1S2P with 1 Thermal Via	95	°C/W
		1S2P without Thermal Via	187	
ESD	Electrostatic Discharge Capability	Human Body Model, JESD22-A114	4	kV
		Charged Device Model, JESD22-C101	2	

Stresses exceeding those listed in the Maximum Ratings table may damage the device. If any of these limits are exceeded, device functionality should not be assumed, damage may occur and reliability may be affected.

### RECOMMENDED OPERATING CONDITIONS

Symbol	Parameter	Min.	Max.	Unit
V <sub>IN</sub>	Supply Voltage	1.0	3.6	V
T <sub>A</sub>	Ambient Operating Temperature	-40	+85	°C

Functional operation above the stresses listed in the Recommended Operating Ranges is not implied. Extended exposure to stresses beyond the Recommended Operating Ranges limits may affect device reliability.

# FPF1504 / FPF1504L

## ELECTRICAL CHARACTERISTICS

Unless otherwise noted,  $V_{IN} = 1.0$  to  $3.6$  V,  $T_A = -40$  to  $+85^\circ\text{C}$ ; Typical Values are at  $V_{IN} = 3.3$  V and  $T_A = 25^\circ\text{C}$ .

Symbol	Parameter	Conditions	Min.	Typ.	Max.	Units
--------	-----------	------------	------	------	------	-------

### BASIC OPERATION

$V_{IN}$	Supply Voltage		1.0		3.6	V	
$I_{Q(OFF)}$	Off Supply Current	FPF1504	$V_{ON} = \text{GND}, V_{OUT} = \text{Open}$		0.25	$\mu\text{A}$	
		FPF1504L	$V_{ON} = V_{IN}, V_{OUT} = \text{Open}$		0.3		
$I_{SD(OFF)}$	Off Switch Current	FPF1504	$V_{ON} = \text{GND}, V_{OUT} = \text{GND}$		0.25		
		FPF1504L	$V_{ON} = V_{IN}, V_{OUT} = \text{GND}$		0.3		
$I_Q$	Quiescent Current	FPF1504	$I_{OUT} = 0$ mA, $V_{IN} = 3.6$ V, $V_{ON} = V_{IN}$		0.08		
			$I_{OUT} = 0$ mA, $V_{ON} = V_{IH(MIN)}$		0.75		
		FPF1504L	$I_{OUT} = 0$ mA, $V_{IN} = 3.6$ V, $V_{ON} = \text{GND}$		0.08		
			$I_{OUT} = 0$ mA, $V_{ON} = V_{IL(MAX)}$		0.95		
$R_{ON}$	On Resistance	$V_{IN} = 3.3$ V, $I_{OUT} = 200$ mA, $T_A = 25^\circ\text{C}$			15	30	$\text{m}\Omega$
		$V_{IN} = 1.8$ V, $I_{OUT} = 200$ mA, $T_A = 25^\circ\text{C}$			20	40	
		$V_{IN} = 1.5$ V, $I_{OUT} = 200$ mA, $T_A = 25^\circ\text{C}$			30		
		$V_{IN} = 1.0$ V, $I_{OUT} = 200$ mA, $T_A = 25^\circ\text{C}$			40	80	
		$V_{IN} = 1.8$ V, $I_{OUT} = 200$ mA, $T_A = 85^\circ\text{C}$ (Note 3)			35	50	
$R_{PD}$	Output Discharge Pull-Down Resistance	$V_{ON} = 0$ V or $V_{IN}$ , $I_{OUT} = -20$ mA			65	95	$\Omega$
$V_{IH}$	On Input Logic High Voltage	FPF1504		0.8		V	
$V_{IL}$	On Input Logic Low Voltage	FPF1504			0.3		
$I_{ON}$	On Input Leakage	$V_{ON} = V_{IN}$ or GND				1	$\mu\text{A}$

### DYNAMIC CHARACTERISTICS

$t_{DON}$	Turn-On Delay (Note 4)	FPF1504	$R_L = 10$ $\Omega$ , $C_L = 0.1$ $\mu\text{F}$ , $V_{IN} = 3.3$ V, $T_A = 25^\circ\text{C}$		80	$\mu\text{s}$	
					130		
					210		
$t_{ON}$	Turn-On Time (Note 4)	FPF1504	$R_L = 500$ $\Omega$ , $C_L = 0.1$ $\mu\text{F}$ , $V_{IN} = 3.3$ V, $T_A = 25^\circ\text{C}$		70	100	$\mu\text{s}$
					95		
$t_R$	$V_{OUT}$ Rise Time (Note 4)	FPF1504			110	150	
		FPF1504L			115		
$t_{ON}$	Turn-On Time (Note 4)	FPF1504			180	250	
		FPF1504L			210		
$t_{DOFF}$	Turn-Off Delay (Note 4)	FPF1504	$R_L = 10$ $\Omega$ , $C_L = 0.1$ $\mu\text{F}$ , $V_{IN} = 3.3$ V, $T_A = 25^\circ\text{C}$		25	30	$\mu\text{s}$
$t_F$	$V_{OUT}$ Fall Time (Note 4)	FPF1504			2		
$t_{OFF}$	Turn-Off Time (Note 4)	FPF1504			27		

# FPF1504 / FPF1504L

## ELECTRICAL CHARACTERISTICS (continued)

Unless otherwise noted,  $V_{IN} = 1.0$  to  $3.6$  V,  $T_A = -40$  to  $+85^\circ\text{C}$ ; Typical Values are at  $V_{IN} = 3.3$  V and  $T_A = 25^\circ\text{C}$ .

Symbol	Parameter	Conditions	Min.	Typ.	Max.	Units
--------	-----------	------------	------	------	------	-------

### DYNAMIC CHARACTERISTICS

Symbol	Parameter	FPF1504	Conditions	Min.	Typ.	Max.	Units
		$t_{DOFF}$		Turn-Off Delay (Note 4)	FPF1504L	$R_L = 500 \Omega, C_L = 0.1 \mu\text{F}, V_{IN} = 3.3 \text{ V}, T_A = 25^\circ\text{C}$	
$t_F$	$V_{OUT}$ Fall Time (Note 4)	FPF1504			12		
		FPF1504L			14		
$t_{OFF}$	Turn-Off Time (Note 4)	FPF1504			37		
		FPF1504L			16		

Product parametric performance is indicated in the Electrical Characteristics for the listed test conditions, unless otherwise noted. Product performance may not be indicated by the Electrical Characteristics if operated under different conditions.

3. This parameter is guaranteed by design and characterization; not production tested.

4.  $t_{DON}/t_{DOFF}/t_R/t_F$  are defined in Figure 7.

5. Output discharge path is enabled during off.

### Timing Diagram – FPF1504

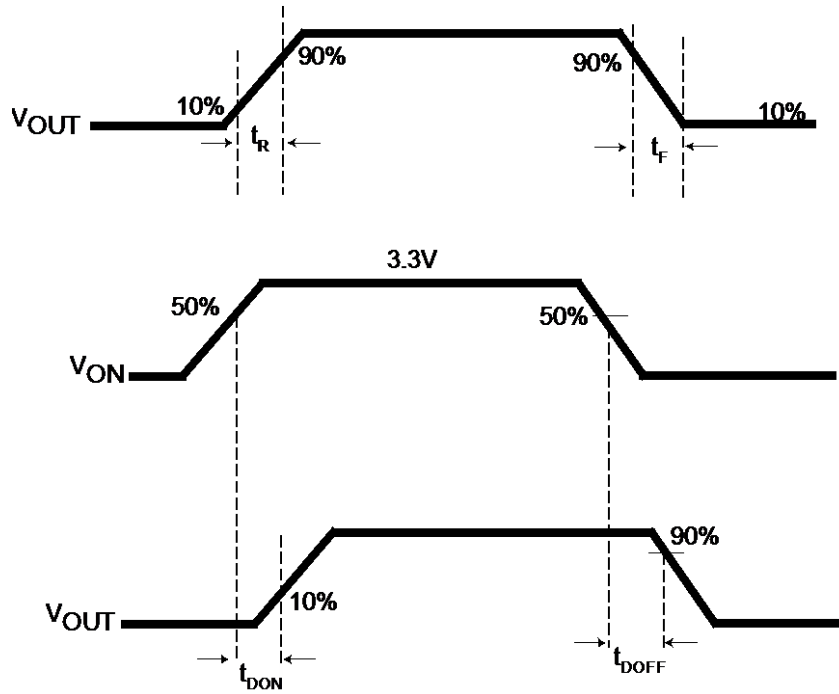

- NOTES: 6.  $t_{ON} = t_R + t_{DON}$ .  
7.  $t_{OFF} = t_F + t_{DOFF}$ .

Figure 7. Timing Diagram for FPF1504

TYPICAL PERFORMANCE CHARACTERISTICS FOR FPF1504

Applicable to active high version only.

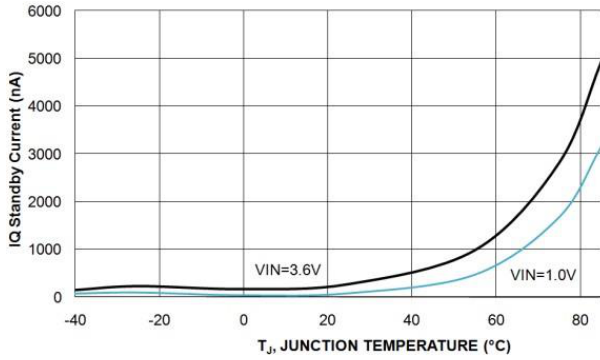

Figure 1. Shutdown Current vs. Temperature

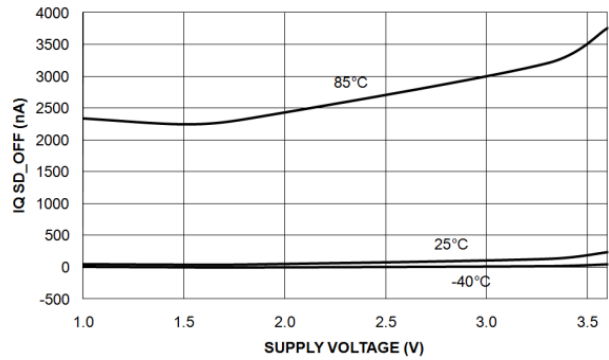

Figure 2. Shutdown Current vs. Supply Voltage

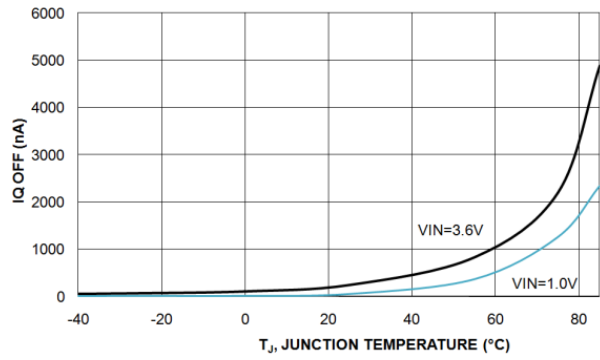

Figure 3. Off Supply Current vs. Temperature

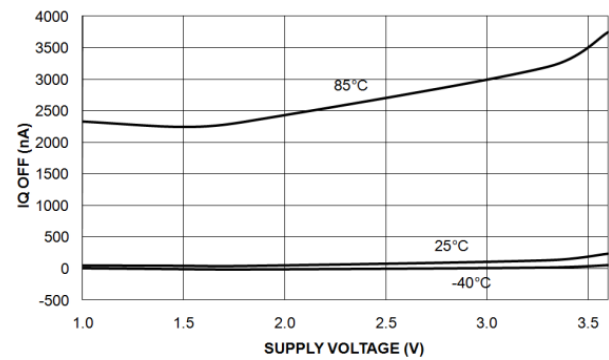

Figure 4. Off Supply Current vs. Supply Voltage

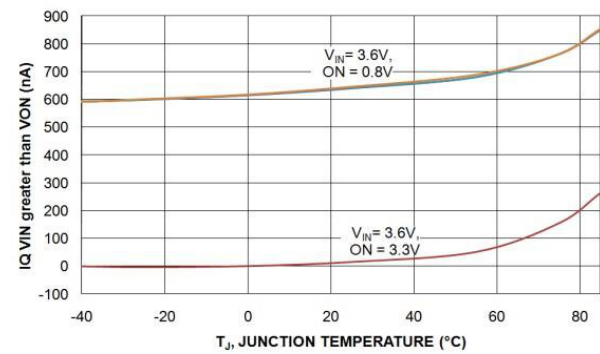

Figure 5. Quiescent Current vs. Temperature

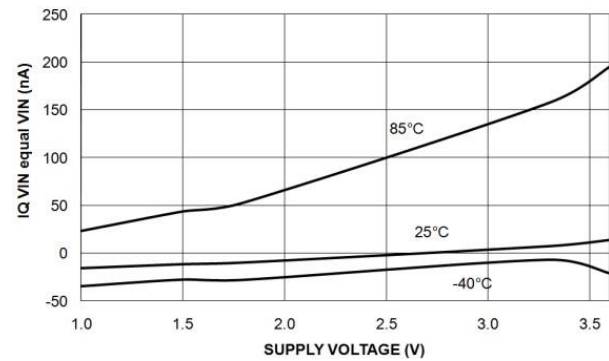

Figure 6. Quiescent Current vs. Supply Voltage  
( $V_{ON} = V_{IN}$ )

# PPF1504 / PPF1504L

## TYPICAL PERFORMANCE CHARACTERISTICS FOR PPF1504

Applicable to active high version only.

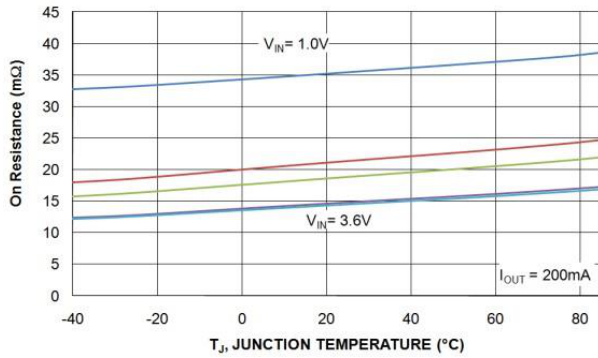

Figure 7.  $R_{ON}$  vs. Temperature

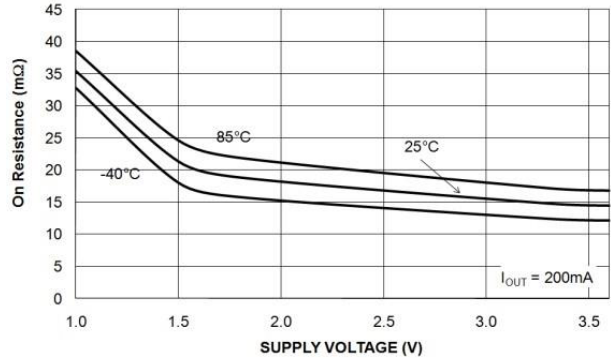

Figure 8.  $R_{ON}$  vs. Temperature

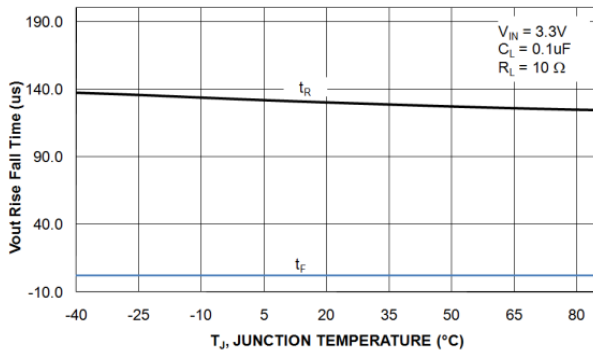

Figure 9.  $V_{OUT}$  Rise/Fall Times vs. Temperature ( $R_L = 10\Omega$ )

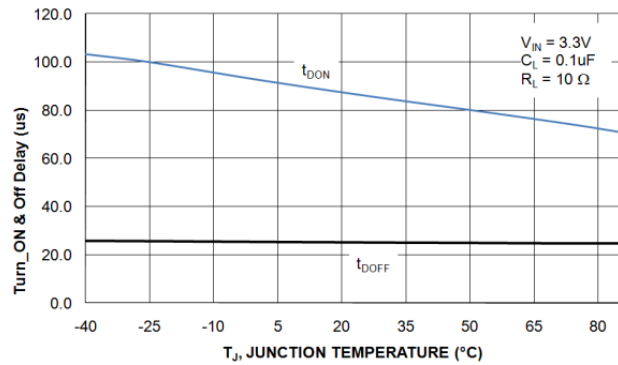

Figure 10.  $V_{OUT}$  Turn-On/Turn-Off Delays vs. Temperature ( $R_L = 10\Omega$ )

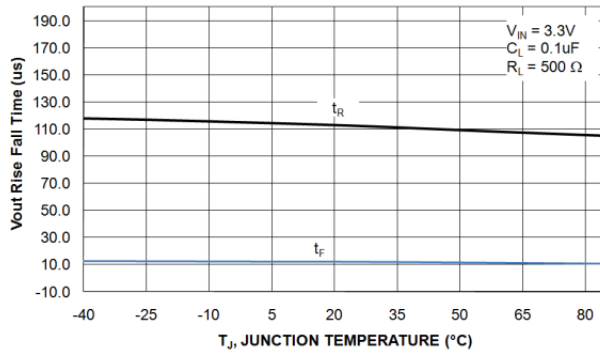

Figure 11.  $V_{OUT}$  Rise/Fall Time vs. Temperature ( $R_L = 500\Omega$ )

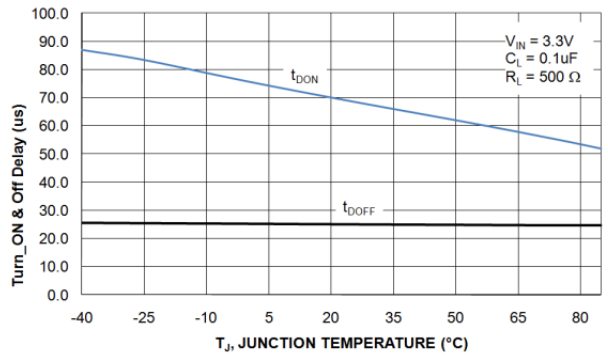

Figure 12.  $V_{OUT}$  Turn-On/Turn-Off Delays vs. Temperature ( $R_L = 500\Omega$ )

TYPICAL PERFORMANCE CHARACTERISTICS FOR FPF1504

Applicable to active high version only.

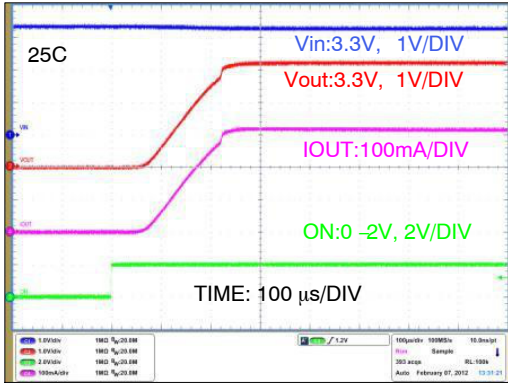

Figure 13. Turn-On Response  
 $(V_{IN} = 3.3\text{ V}, C_{OUT} = 0.1\ \mu\text{F}, R_L = 10\ \Omega)$

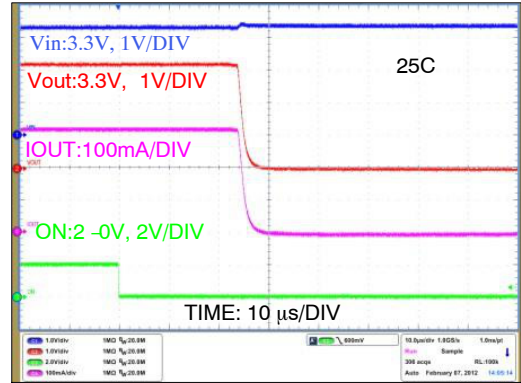

Figure 14. Turn-Off Response  
 $(V_{IN} = 3.3\text{ V}, C_{OUT} = 0.1\ \mu\text{F}, R_L = 10\ \Omega)$

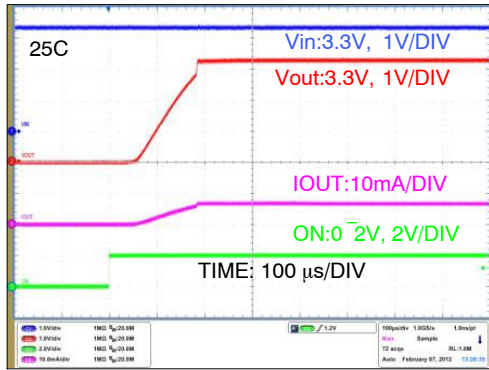

Figure 15. Turn-On Response  
 $(V_{IN} = 3.3\text{ V}, C_{OUT} = 0.1\ \mu\text{F}, R_L = 500\ \Omega)$

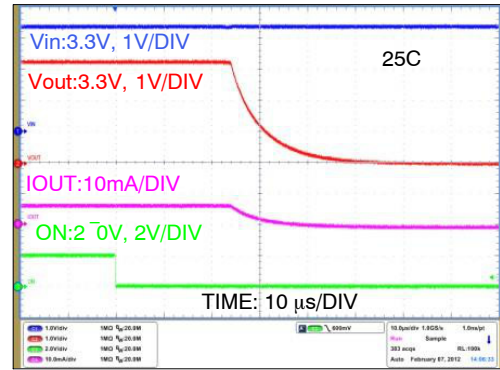

Figure 16. Turn-Off Response  
 $(V_{IN} = 3.3\text{ V}, C_{OUT} = 0.1\ \mu\text{F}, R_L = 500\ \Omega)$



APPLICATION INFORMATION

**Input Capacitor**

IntelliMAX switches don't require an input capacitor. To reduce device inrush current, a 0.1 µF ceramic capacitor, C<sub>IN</sub>, is recommended close to the VIN pin. A higher value of C<sub>IN</sub> can be used to further reduce the voltage drop experienced as the switch is turned on into a large capacitive load.

**Output Capacitor**

IntelliMAX switches work without an output capacitor. If the applications parasitic board inductance forces V<sub>OUT</sub> below GND when switching off, a 0.1 µF capacitor, C<sub>OUT</sub>, should be placed between V<sub>OUT</sub> and GND.

**Fall Time**

Device output fall time can be calculated based on RC constant of external components as follows:

$$t_F = R_L \times C_L \times 2.2 \quad (\text{eq. 1})$$

where t<sub>F</sub> is 90% to 10% fall time, R<sub>L</sub> is output, load and C<sub>L</sub> is output capacitor.

The same equation works for a device with a pull-down output resistor, then R<sub>L</sub> is replaced by a parallel connected pull-down and external output resistor combination, as follows:

$$t_F = \frac{R_L \times R_{PD} \times C_L}{R_L + R_{PD}} \times 2.2 \quad (\text{eq. 2})$$

where t<sub>F</sub> is 90% to 10% fall time, R<sub>L</sub> is output load, R<sub>PD</sub> is output pull-down resistor (65 Ω typical), and C<sub>L</sub> is the output capacitor.

RECOMMENDED LAND PATTERN AND LAYOUT

For best thermal performance and minimal inductance and parasitic effects, it is recommended to keep input and output traces short and the capacitors as close to the device

as possible. Below is a recommended layout for this device to achieve optimum performance.

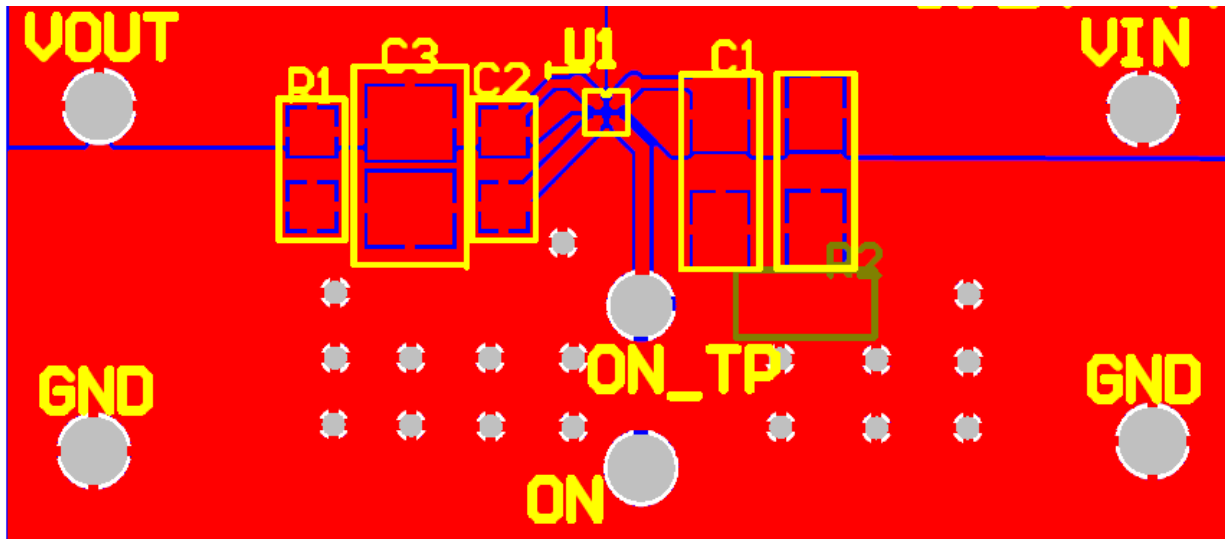

Figure 17. Recommended Land Pattern and Layout

The following information applies to the WLCSP package dimensions on the next page:

PRODUCT-SPECIFIC DIMENSIONS

Product	D	E	X	Y
FPF1504UCX	960 µm ±30 µm	960 µm ±30 µm	0.230 mm	0.230 mm
FPF1504BUCX				
FPF1504LUCX				
FPF1504LUCX				

IntelliMAX is a trademark of Semiconductor Components Industries, LLC (SCILLC) or its subsidiaries in the United States and/or other countries.

**WLCSP4 0.96x0.96x0.582**  
CASE 567RH  
ISSUE O

DATE 30 NOV 2016

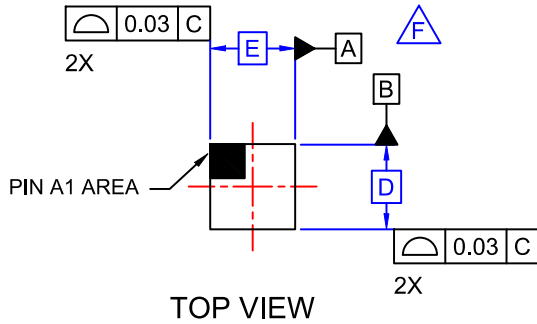

TOP VIEW

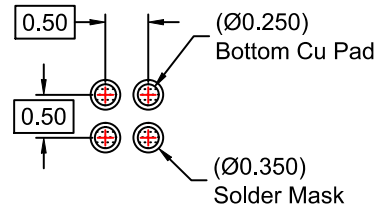

RECOMMENDED LAND PATTERN  
(NSMD PAD TYPE)

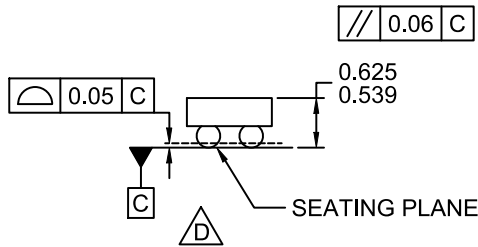

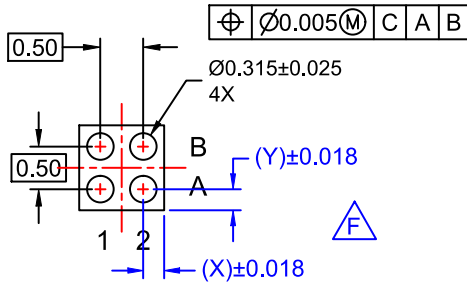
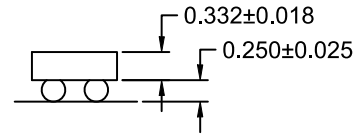

SIDE VIEWS



BOTTOM VIEW

NOTES:

- A. NO JEDEC REGISTRATION APPLIES.
- B. DIMENSIONS ARE IN MILLIMETERS.
- C. DIMENSIONS AND TOLERANCES PER ASME Y14.5M, 2009.
-  D. DATUM C IS DEFINED BY THE SPHERICAL CROWNS OF THE BALLS.
- E. PACKAGE NOMINAL HEIGHT IS 582 MICRONS ±43 MICRONS (539-625 MICRONS).
-  F. FOR DIMENSIONS D, E, X, AND Y SEE PRODUCT DATASHEET.

<b>DOCUMENT NUMBER:</b>	<b>98AON16575G</b>	Electronic versions are uncontrolled except when accessed directly from the Document Repository. Printed versions are uncontrolled except when stamped "CONTROLLED COPY" in red.
<b>DESCRIPTION:</b>	<b>WLCSP4 0.96x0.96x0.582</b>	<b>PAGE 1 OF 1</b>

ON Semiconductor and  are trademarks of Semiconductor Components Industries, LLC dba ON Semiconductor or its subsidiaries in the United States and/or other countries. ON Semiconductor reserves the right to make changes without further notice to any products herein. ON Semiconductor makes no warranty, representation or guarantee regarding the suitability of its products for any particular purpose, nor does ON Semiconductor assume any liability arising out of the application or use of any product or circuit, and specifically disclaims any and all liability, including without limitation special, consequential or incidental damages. ON Semiconductor does not convey any license under its patent rights nor the rights of others.

ON Semiconductor and  are trademarks of Semiconductor Components Industries, LLC dba ON Semiconductor or its subsidiaries in the United States and/or other countries. ON Semiconductor owns the rights to a number of patents, trademarks, copyrights, trade secrets, and other intellectual property. A listing of ON Semiconductor's product/patent coverage may be accessed at [www.onsemi.com/site/pdf/Patent-Marking.pdf](http://www.onsemi.com/site/pdf/Patent-Marking.pdf). ON Semiconductor reserves the right to make changes without further notice to any products herein. ON Semiconductor makes no warranty, representation or guarantee regarding the suitability of its products for any particular purpose, nor does ON Semiconductor assume any liability arising out of the application or use of any product or circuit, and specifically disclaims any and all liability, including without limitation special, consequential or incidental damages. Buyer is responsible for its products and applications using ON Semiconductor products, including compliance with all laws, regulations and safety requirements or standards, regardless of any support or applications information provided by ON Semiconductor. "Typical" parameters which may be provided in ON Semiconductor data sheets and/or specifications can and do vary in different applications and actual performance may vary over time. All operating parameters, including "Typicals" must be validated for each customer application by customer's technical experts. ON Semiconductor does not convey any license under its patent rights nor the rights of others. ON Semiconductor products are not designed, intended, or authorized for use as a critical component in life support systems or any FDA Class 3 medical devices or medical devices with a same or similar classification in a foreign jurisdiction or any devices intended for implantation in the human body. Should Buyer purchase or use ON Semiconductor products for any such unintended or unauthorized application, Buyer shall indemnify and hold ON Semiconductor and its officers, employees, subsidiaries, affiliates, and distributors harmless against all claims, costs, damages, and expenses, and reasonable attorney fees arising out of, directly or indirectly, any claim of personal injury or death associated with such unintended or unauthorized use, even if such claim alleges that ON Semiconductor was negligent regarding the design or manufacture of the part. ON Semiconductor is an Equal Opportunity/Affirmative Action Employer. This literature is subject to all applicable copyright laws and is not for resale in any manner.

## PUBLICATION ORDERING INFORMATION

### LITERATURE FULFILLMENT:

Email Requests to: [orderlit@onsemi.com](mailto:orderlit@onsemi.com)

ON Semiconductor Website: [www.onsemi.com](http://www.onsemi.com)

### TECHNICAL SUPPORT

North American Technical Support:  
Voice Mail: 1 800-282-9855 Toll Free USA/Canada  
Phone: 011 421 33 790 2910

Europe, Middle East and Africa Technical Support:

Phone: 00421 33 790 2910

For additional information, please contact your local Sales Representative