



产 品 规 格 书

PRODUCT SPECIFICATION

客户名称 CUSTOMER: _____

产品型号 MODEL: HMB1275-24B

客户型号 USER'S MODEL: _____

日 期 DATE: 2019-12-12

江苏华能电子有限公司			客户回签		
HUAWHA			CUSTOMER		
SERVE RATITY			CUSTOMER RATIGY		
拟制 REPORT	核 对 CHECKED	批 准 APPROVED	检 验 TEST	审 核 CHECKED	批 准 APPROVED
王文娟	工 程 师 用 章	张长华			

江苏华能电子有限公司
 JIANGSU HUAWHA ELECTRONICS CO.,LTD
 地址：江苏省泰州市兴化市陈堡镇工业园区
 ADD:Chenbao Industrial Park, Chenbao Town, Xinghua,Taizhou City, Jiangsu China.
 电话 [TEL:0523-83710666](tel:0523-83710666) 传真 FAX:0523-83724866
 网址: www.huawha.com 邮箱: hndz_wwj@huawha.com

1.基本规格/General specification

项目/Item		规格/Spec	条件/Condition
1	额定电压 Rated voltage	24VDC	
2	工作电压 Operation voltage	18~28VDC	
3	声压 Sound Pressure Level=SPL	Min 85dB	测试环境：标准状态，标准驱动电路， 额定电压 测试距离：0.1m Standard State,Standard Drive Circuit. Rated voltage,Distance at 0.1m
4	电流 current	Max25mA	
5	振荡频率 Oscillation frequency	2400±300Hz	
6	工作温度范围 Operating Temperature	-20~+70℃	
7	保存温度范围 Storage temperature	-40~+85℃	
8	外部尺寸 Externals size (mm)	φ 12*H7.5	参阅附图 Refer to the attached drawing
9	重量 Mass	1.8g	
10	材质 Housing Material	PBT	

2.电气和声学测试条件/Electrical And Acoustical Measuring Condition

驱动电路/Recommended Driving Circuit

设置 Recommended Setting

Resonant frequency, 1/2 duty cycle. Square wave.
Signal amplitude should be large enough to saturate the transistor.

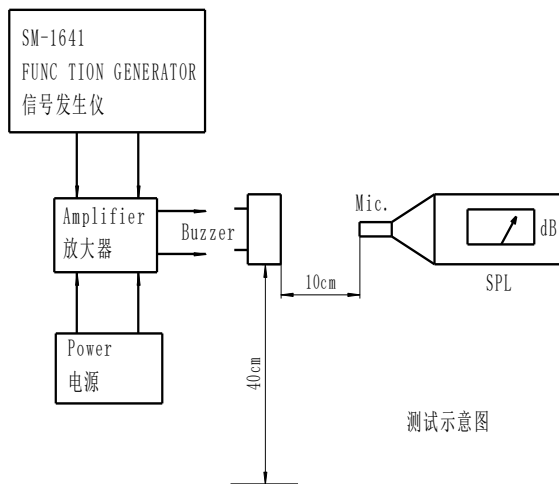
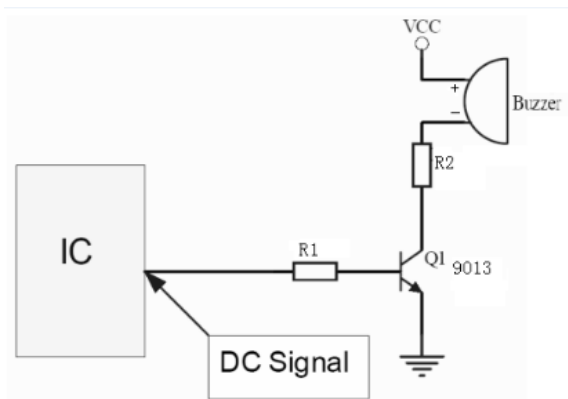

3.可靠性测试/Reliability Test

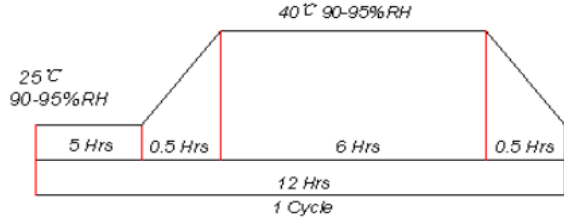
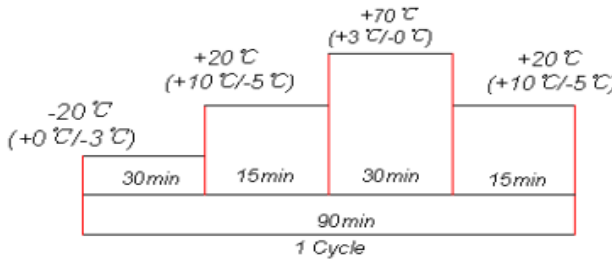
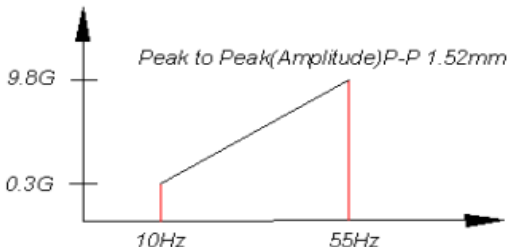
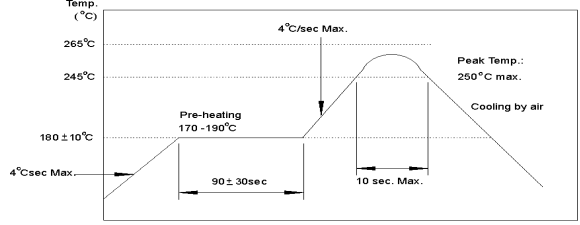
	项目 ITEM	测试方法 TEST
1	高温试验 High Temperature Test	在+80℃±2℃储存温度下存放 96 小时，恢复 2 小时后测试 After being placed in a chamber with +80±2℃ for 96 hours and then being placed in normal condition for 2 hours
2	低温试验 Low Temperature Test	在-20℃±2℃储存温度下存放 96 小时，恢复 2 小时后测试 After being placed in a chamber with -20±2℃ for 96 hours and then being placed in normal condition for 2 hours
3	恒定湿热试验 Humidity Test	 <p>The diagram shows a humidity test cycle. It starts with a 5-hour dwell at 25°C and 90-95% RH. This is followed by a 0.5-hour ramp up to 40°C and 90-95% RH. The test then holds at 40°C and 90-95% RH for 6 hours. Finally, there is a 0.5-hour ramp down. The total duration of one cycle is 12 hours.</p>
4	温度变化试验 Temperature Cycle Test	 <p>The diagram illustrates a temperature cycle test. It begins with a 30-minute dwell at -20°C (+0°C/-3°C). This is followed by a 15-minute ramp up to +20°C (+10°C/-5°C). The test then holds at +20°C for 30 minutes. Next, there is a 15-minute ramp up to +70°C (+3°C/-0°C). The test holds at +70°C for 30 minutes. Finally, there is a 15-minute ramp down to +20°C (+10°C/-5°C). The total duration of one cycle is 90 minutes.</p>
5	振动试验 Vibration Test	 <p>The diagram shows a vibration test profile. The vertical axis represents acceleration in G, with markers at 0.3G and 9.8G. The horizontal axis represents frequency in Hz, with markers at 10Hz and 55Hz. The test starts at 0.3G at 10Hz and ramps up linearly to 9.8G at 55Hz. The peak-to-peak amplitude is specified as P-P 1.52mm.</p>
6	跌落试验 Drop Test	70cm 高自由掉落到 40mm 的木板上，每个方向三次 Drop on a hard wood board of 40mm thick, any directions, three times, at the height of 70cm
7	插针的抗拉强度试验 Terminal Strength Pulling Test	插针承受 1.0kg 拉力，负荷时间 5s The force 5 seconds of 1.0kg is applied to each terminal.
8	可焊性试验 Solder ability Test	焊锡温度 255±5℃，浸润时间为 3±0.5s，试验后目测产品情况 Lead terminals are immersed in rosin for 5 seconds and then immersed in solder bath of 255±5℃ for 3±0.5 seconds.
9	回流焊测试 Soldering Test	 <p>The diagram shows the temperature profile for a soldering test. The vertical axis is Temperature (°C) with markers at 180±10°C, 245°C, and 265°C. The horizontal axis is Time (Sec). The profile starts with a ramp up at 4°C/sec Max. to a pre-heating stage at 170-190°C for 90±30sec. This is followed by a second ramp up at 4°C/sec Max. to a peak temperature of 250°C max. for 10 sec. Max. The final stage is cooling by air.</p>

--	--	--

4.尺寸图 Dimension

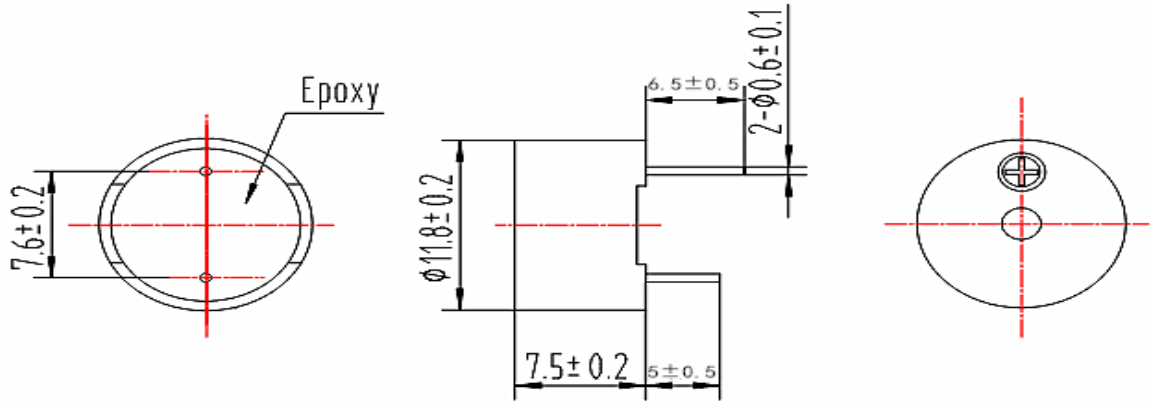

*Unit: mm; Tolerance: ± 0.3 mm Except Specified

*Housing Material: Black PBT

5.频率响应/Frequency Response

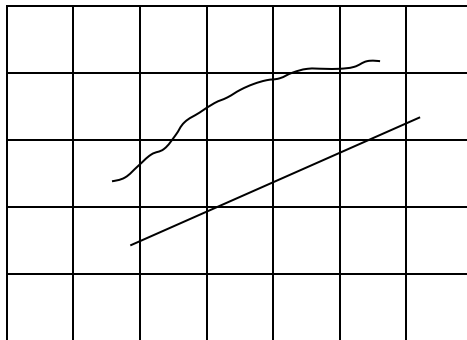

90DB

25MA

85DB

16 24 32 VDC

16Vo-p 50% duty Square wave,10cm

5.包装 picking



QTY:100PCS



QTY:1000PCS



QTY:5000PCS

SIZE:50*42*27cm