

SPECIFICATIONS

- 1、Current Rating: 7A AC, DC
- 2、Voltage Rating: 250V AC, DC
- 3、Temperatuer Range: -25℃~+85℃
- 4、Contact Resistance: 20mΩ Max
- 5、Insulation Resistance: 1000MΩ Min
- 6、Withstanding Voltang: 1500V AC/minute
- 7、Material: Wafer Nylon66, UL94V-0
PIN Brass Tin-plated

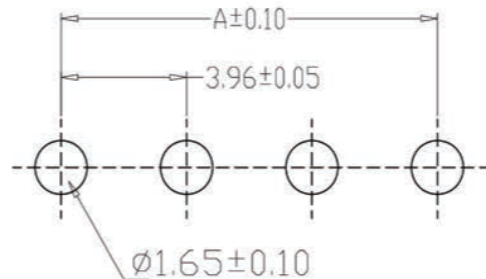
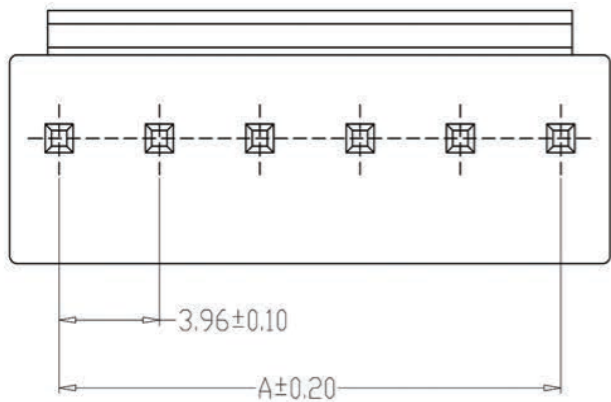

PCB LAYOUT

编号	尺寸 (mm)	
	A	B
A3961-02A	3.96	7.92
A3961-03A	7.92	11.88
A3961-04A	11.88	15.84
A3961-05A	15.84	19.80
A3961-06A	19.80	23.76
A3961-07A	23.76	27.72
A3961-08A	27.72	31.68
A3961-09A	31.68	35.64
A3961-10A	35.64	39.60
A3961-11A	39.60	43.56
A3961-12A	43.56	47.52

制图 DRAWN	变更内容 DESCRIPTION	日期 DATE	GENERAL TOLERANCE		制图 DRAWING	钱岳生 2013、07、01	料号 PART NO.	A3961-NA	版本 REV.	A
			.X±0.25	.X'±2'						
			.X±0.20	.X'±1'	核准 APPROVAL	张名 2013、07、05	客户料号 CUTM. NO.			
			.XX±0.15	.XX'±0.5'	单位 UNITS	MM	比例 SCALE	1:1	深圳市金航标电子有限公司	WWW.BDS666.COM
			.XXX±0.10	.XXX'±0.5'					KH-VH-2P-Z	0755-83044319