

100V N-Channel MOSFET

FEATURES

- Fast switching
- 100% avalanche tested
- Improved dv/dt capability

APPLICATIONS

- Switch Mode Power Supply (SMPS)
- Uninterruptible Power Supply (UPS)
- Power Factor Correction (PFC)

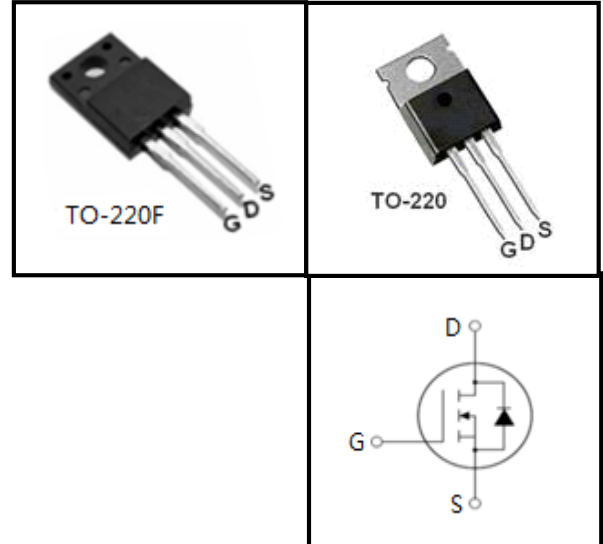

Absolute Maximum Ratings $T_C = 25^\circ\text{C}$, unless otherwise noted

Parameter	Symbol	Value		Unit
		TO220F	TO-220	
Drain-Source Voltage ($V_{GS} = 0V$)	V_{DSS}	100		V
Continuous Drain Current	I_D	16		A
Pulsed Drain Current (note1)	I_{DM}	64		A
Gate-Source Voltage	V_{GSS}	± 30		V
Single Pulse Avalanche Energy (note2)	E_{AS}	211		mJ
Avalanche Current (note1)	I_{AS}	6.5		A
Repetitive Avalanche Energy (note1)	E_{AR}	126		mJ
Power Dissipation ($T_C = 25^\circ\text{C}$)	P_D	98	160	W
Operating Junction and Storage Temperature Range	T_J, T_{stg}	-55~+150		$^\circ\text{C}$

Thermal Resistance

Parameter	Symbol	Value		Unit
		TO220F	TO-220	
Thermal Resistance, Junction-to-Case	R_{thJC}	1.78	1.08	$^\circ\text{C/W}$
Thermal Resistance, Junction-to-Ambient	R_{thJA}	62.5	60	

Specifications $T_J = 25^{\circ}\text{C}$, unless otherwise noted

Parameter	Symbol	Test Conditions	Value			Unit
			Min.	Typ.	Max.	
Static						
Drain-Source Breakdown Voltage	$V_{(BR)DSS}$	$V_{GS} = 0V, I_D = 250\mu A$	100	--	--	V
Zero Gate Voltage Drain Current	I_{DSS}	$V_{DS} = 100V, V_{GS} = 0V, T_J = 25^{\circ}\text{C}$	--	--	1	μA
Gate-Source Leakage	I_{GSS}	$V_{GS} = \pm 30V$	--	--	± 100	nA
Gate-Source Threshold Voltage	$V_{GS(th)}$	$V_{DS} = V_{GS}, V_{DS} = 250\mu A$	3.0	--	4.0	V
Drain-Source On-Resistance (Note3)	$R_{DS(on)}$	$V_{GS} = 10V, I_D = 8A$	--	0.080	0.098	Ω
Dynamic						
Input Capacitance	C_{iss}	$V_{GS} = 0V,$ $V_{DS} = 25V,$ $f = 1.0\text{MHz}$	--	519	--	pF
Output Capacitance	C_{oss}		--	173	--	
Reverse Transfer Capacitance	C_{rss}		--	103	--	
Total Gate Charge	Q_g	$V_{DD} = 80V, I_D = 16A,$ $V_{GS} = 10V$	--	34	--	nC
Gate-Source Charge	Q_{gs}		--	6	--	
Gate-Drain Charge	Q_{gd}		--	17	--	
Turn-on Delay Time	$t_{d(on)}$	$V_{DD} = 50V, I_D = 16A,$ $R_G = 25\Omega$	--	34	--	ns
Turn-on Rise Time	t_r		--	40	--	
Turn-off Delay Time	$t_{d(off)}$		--	140	--	
Turn-off Fall Time	t_f		--	49	--	
Drain-Source Body Diode Characteristics						
Continuous Body Diode Current	I_S	$T_C = 25^{\circ}\text{C}$	--	--	16	A
Pulsed Diode Forward Current	I_{SM}		--	--	64	
Body Diode Voltage	V_{SD}	$T_J = 25^{\circ}\text{C}, I_{SD} = 8A, V_{GS} = 0V$	--	--	1.4	V
Reverse Recovery Time	t_{rr}	$V_{GS} = 0V, I_F = 16A,$ $di_F/dt = 100A/\mu s$	--	594	--	ns
Reverse Recovery Charge	Q_{rr}		--	0.65	--	μC

Notes

1. Repetitive Rating: Pulse width limited by maximum junction temperature
2. $L=10\text{mH}, V_{DD} = 50V, R_G = 25\Omega,$ Starting $T_J = 25^{\circ}\text{C}$
3. Pulse Test: Pulse width $\leq 300\mu s,$ Duty Cycle $\leq 1\%$

Typical Characteristics $T_J = 25^\circ\text{C}$, unless otherwise noted

Figure 1. Output Characteristics ($T_J = 25^\circ\text{C}$)

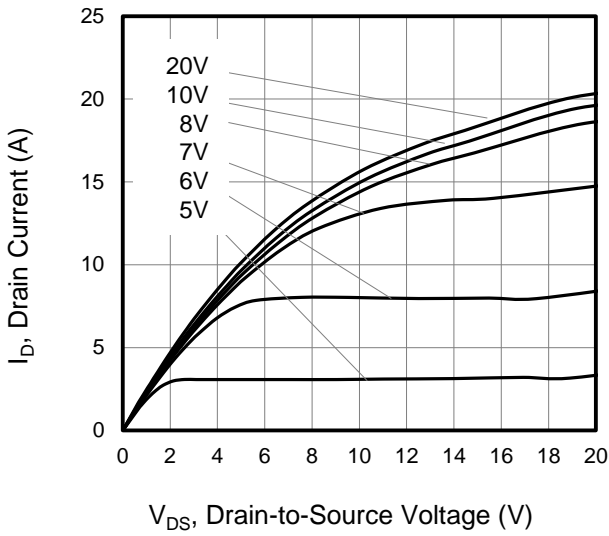

Figure 2. Body Diode Forward Voltage

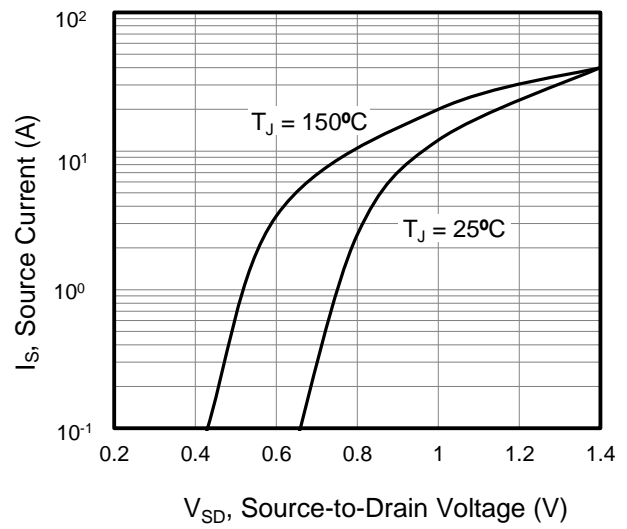

Figure 3. Drain Current vs. Temperature

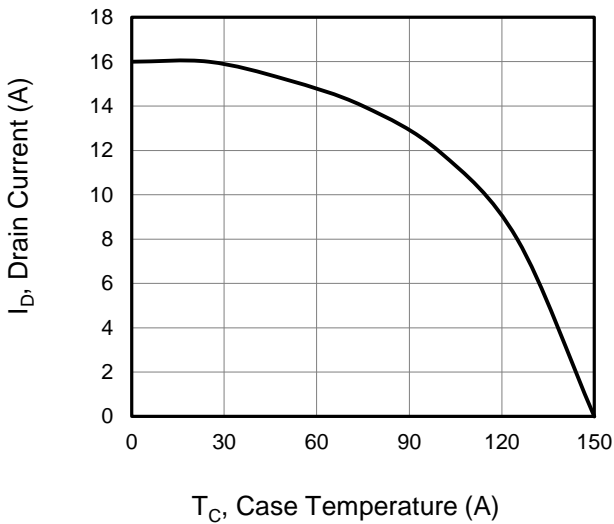

Figure 4. BV_{DSS} Variation vs. Temperature

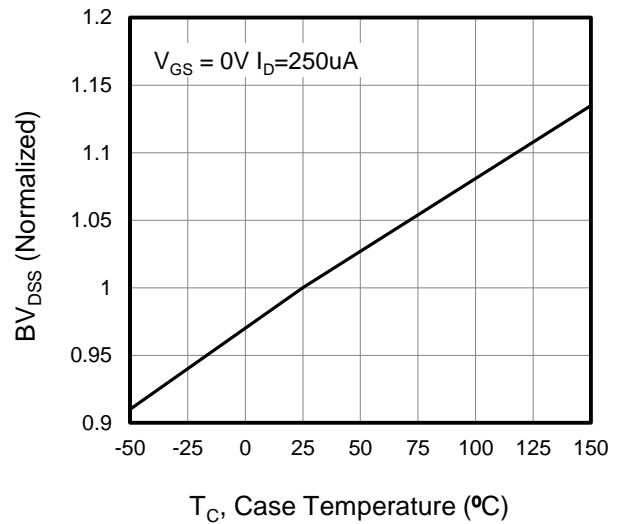

Figure 5. Transfer Characteristics

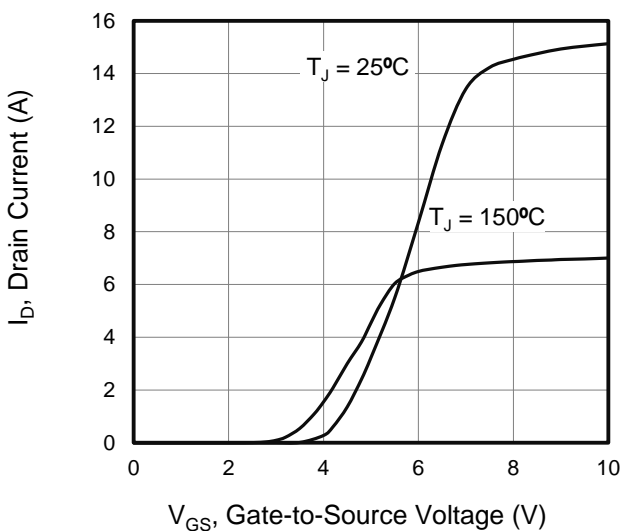
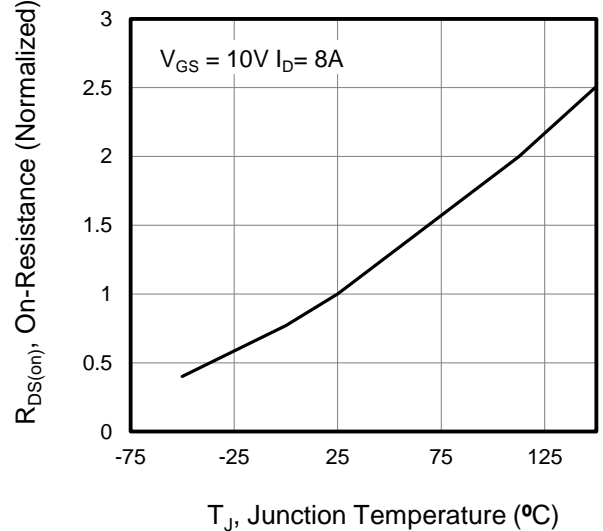

Figure 6. On-Resistance vs. Temperature



Typical Characteristics $T_J = 25^\circ\text{C}$, unless otherwise noted

Figure 7. Capacitance

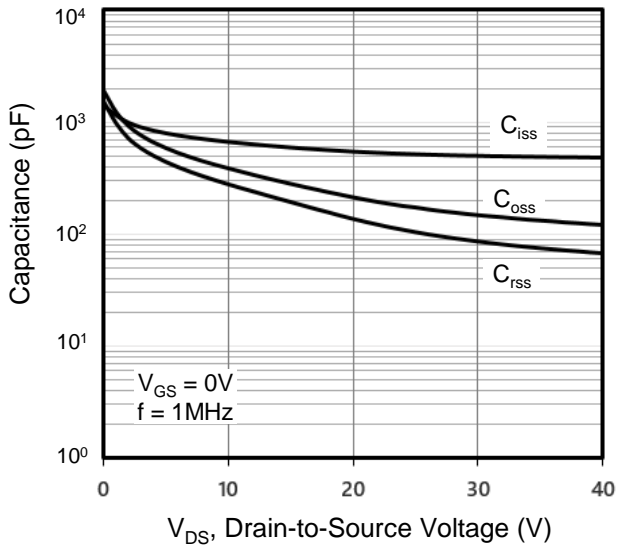

Figure 8. Gate Charge

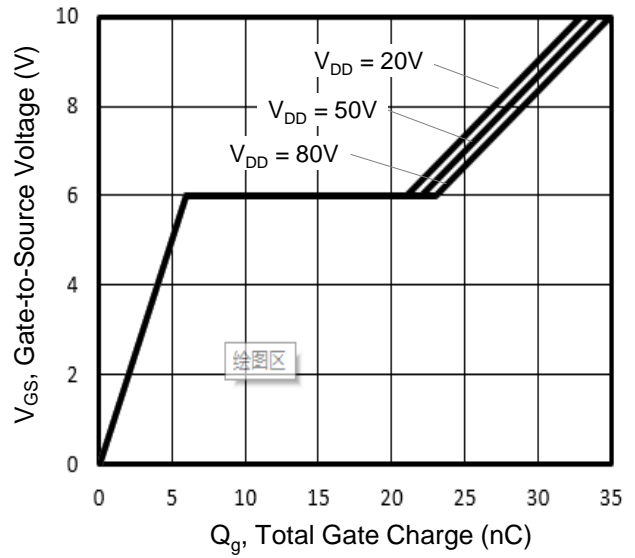

Figure 9. Transient Thermal Impedance

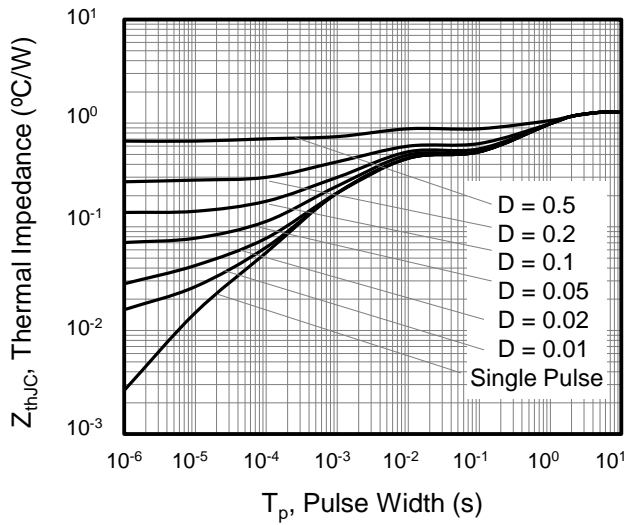

Figure A: Gate Charge Test Circuit and Waveform



Figure B: Resistive Switching Test Circuit and Waveform

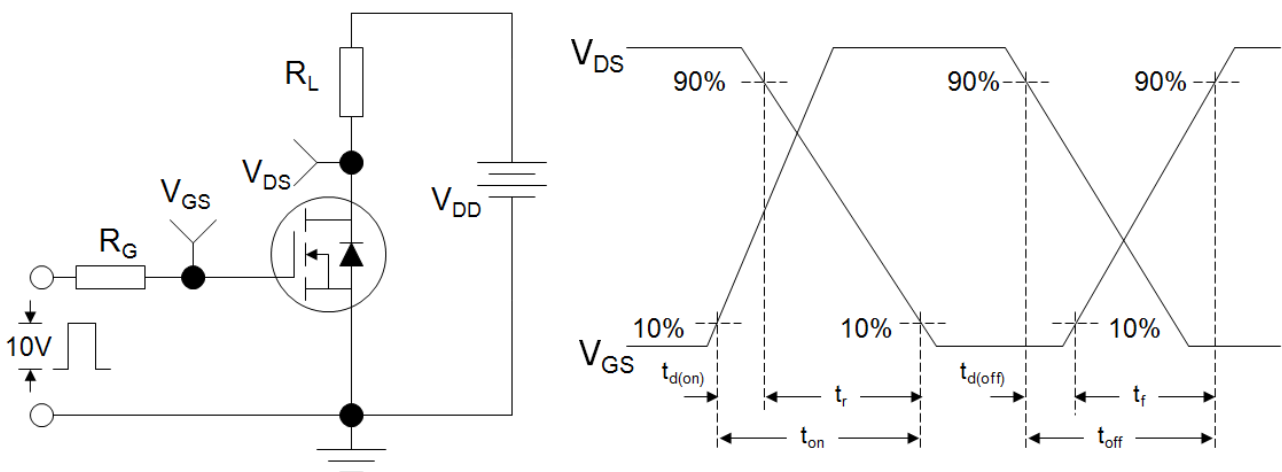
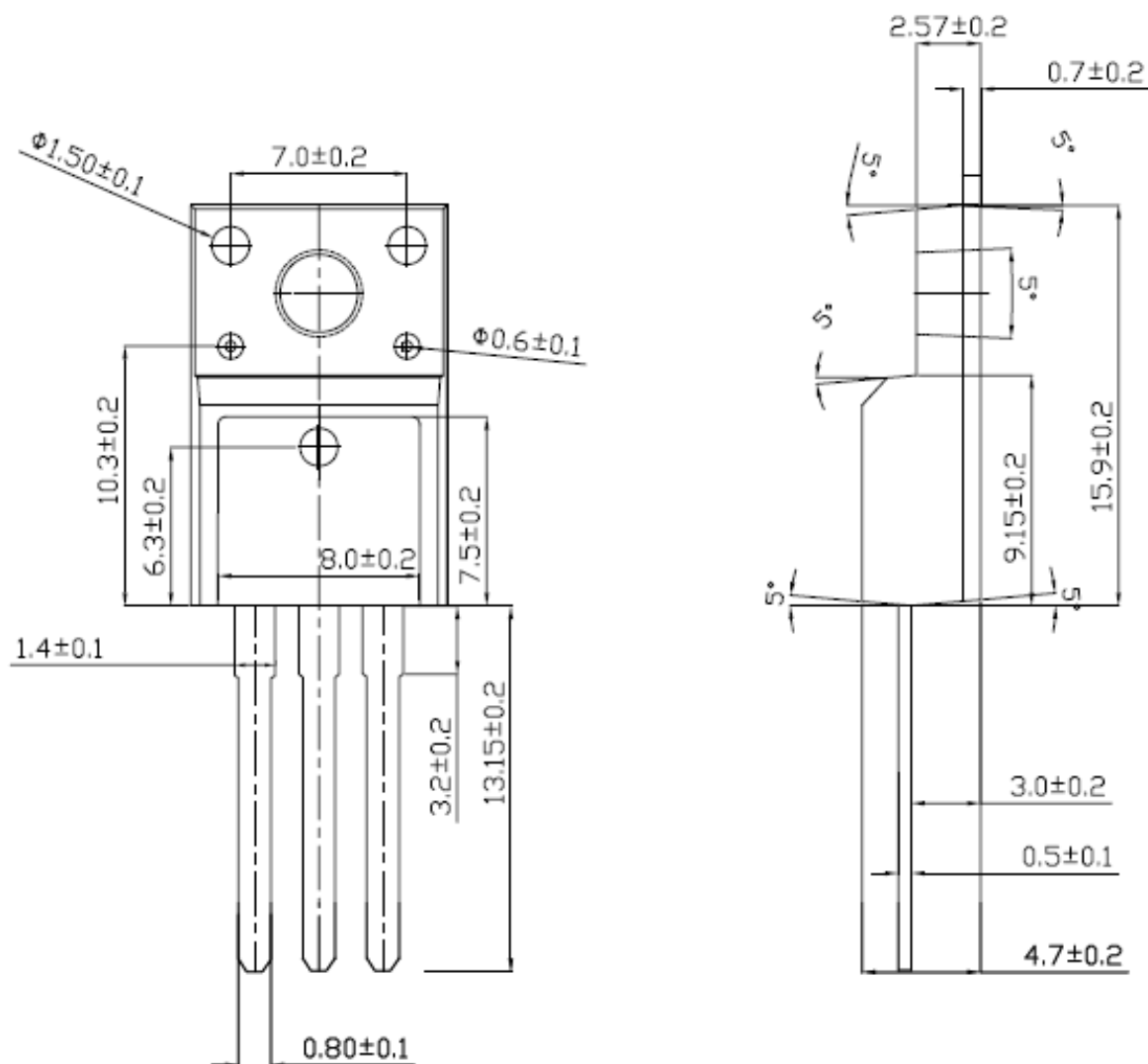

Figure C: Unclamped Inductive Switching Test Circuit and Waveform



TO-220F



TO-220

