



承認書

Specification For Approval

Customer: (客戶)

Description: (產品描述)

SMD0603燈珠側發紅光

Part number: (產品型號)

TJ-S1706CL6T5ALC2R-A5

Date: (日期)

Approved By: (客戶承認)

--

Prepared By: (我司承認)

Approval	Check	Design	Sales

核准

審核

製作

業務

Customer Service Hotline: **400-676-8616**

TEL: 0769-8662 5999 0769-8200 2226

E-MAIL : dg@togialed.com

FAX: 0769-8200 2227

WEB: www.togialed.com

Features

- 1.7mm x 0.6mm SMT LED, 1.1mm thickness
- Low power consumption
- Wide view angle
- Package: 4000pcs/reel
- RoHS Compliant

Applications

- Ideal for back light and indicator
- Various colors and lens types available

Package outlines

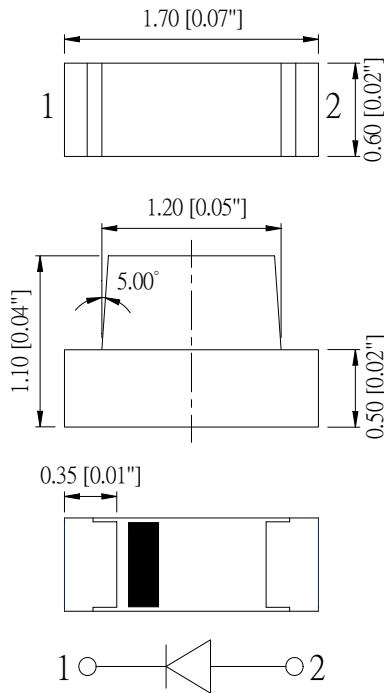

Recommend Pad Layout

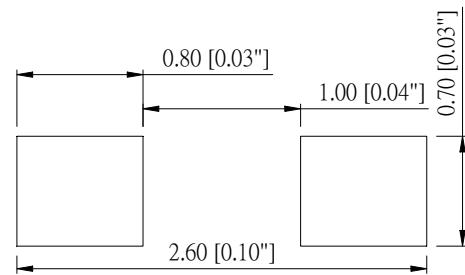

Part No.	Emitted color	Dice	Lens color
TJ-S1706CL6T5ALC2R-A5	Red	AlGaInP	Water transparent

Notes:

- All dimensions are in millimeters (inches);
- Tolerances are $\pm 0.1\text{mm}$ (0.004inch) unless otherwise noted.

Absolute maximum ratings (TA=25°C)

Parameter	Symbol	Value	Unit
Forward current	If	30	mA
Reverse voltage	Vr	5	V
Power dissipation	Pd	72	mW
Operating temperature	Top	-20 ~+80	°C
Storage temperature	Tstg	-30 ~+85	°C
Peak pulsing current (1/8 duty f=1kHz)	Ifp	125	mA

Electro-optical characteristics (TA=25°C)

Parameter	Test Condition	Symbol	Value			Unit
			Min	Typ	Max	
Wavelength at peak emission	If=20mA	λ_p	--	625	--	nm
Spectral half bandwidth	If=20mA	$\Delta \lambda$	--	18	--	nm
Dominant wavelength	If=20mA	λ_d	620	--	630	nm
Forward voltage	If=20mA	Vf	1.8	--	2.4	V
Luminous intensity	If=20mA	Iv	63	--	200	mcd
Viewing angle at 50% Iv	If=10mA	$2\theta_{1/2}$	--	120	--	Deg
Reverse current	Vr=5V	Ir	--	--	10	μA

Optical characteristic curves

Relative Intensity vs. Wavelength

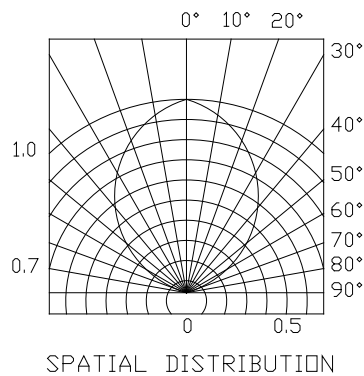
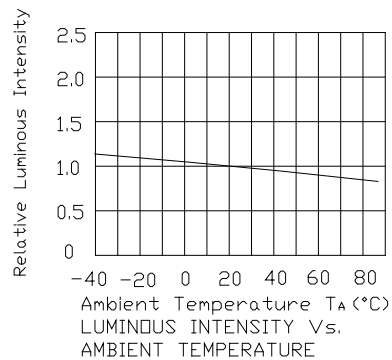
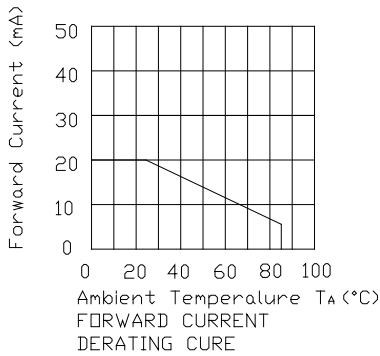
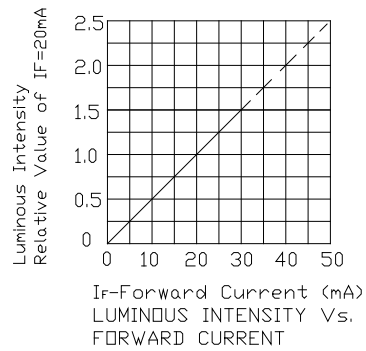
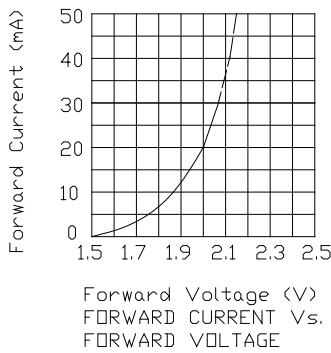
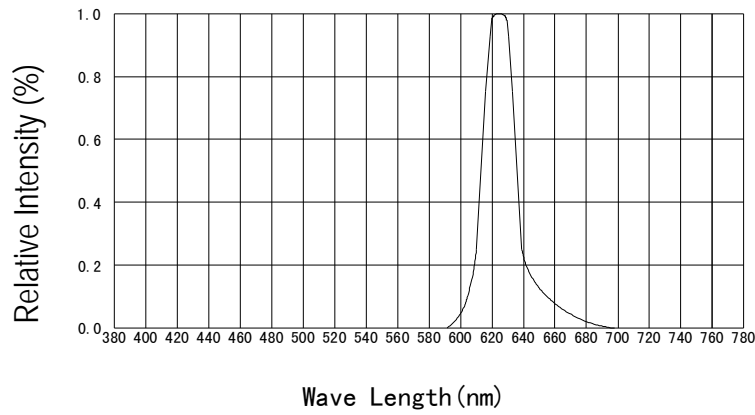

Reflow Profile

■ Reflow Temp/Time

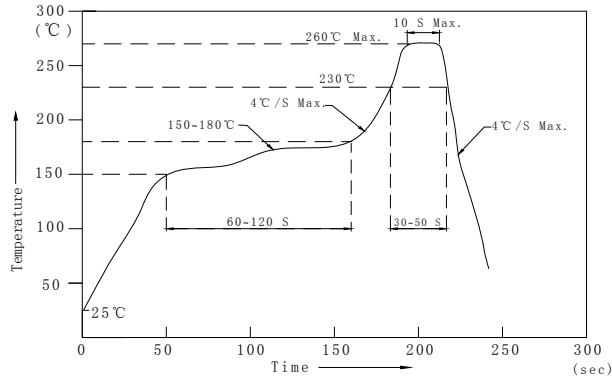

Notes:

1. We recommend the reflow temperature $245^{\circ}\text{C}(\pm 5^{\circ}\text{C})$. the maximum soldering temperature should be limited to 260°C .
2. Don't cause stress to the epoxy resin while it is exposed to high temperature.
3. Number of reflow process shall be 2 times or less.

■ Soldering iron

Basic spec is $\leq 5\text{sec}$ when 260°C . If temperature is higher, time should be shorter ($+10^{\circ}\text{C} \rightarrow -1\text{sec}$). Power dissipation of iron should be smaller than 20W, and temperatures should be controllable. Surface temperature of the device should be under 230°C .

■ Rework

1. Customer must finish rework within 5 sec under 260°C .
2. The head of iron can not touch copper foil
3. Twin-head type is preferred.

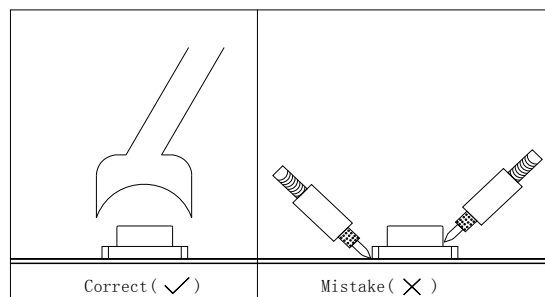

- Avoid rubbing or scraping the resin by any object, during high temperature, for example reflow solder etc.

Test circuit and handling precautions

■ Test circuit

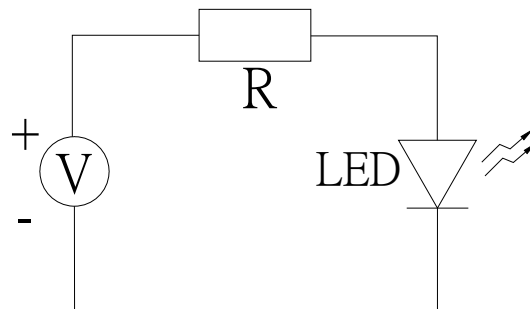

■ Handling precautions

1. Over-current-proof

Customer must apply resistors for protection; otherwise slight voltage shift will cause big current change (Burn out will happen).

2. Storage

2.1 It is recommended to store the products in the following conditions:

Humidity: 60% R.H. Max.

Temperature : 5°C~30°C(41°F~86°F)

2.2 Shelf life in sealed bag: 12 month at $5^{\circ}\text{C}\sim 30^{\circ}\text{C}$ and <math>< 30\% \text{ R.H.}</math> after the package is Opened, the products should be used within a week or they should be keeping to stored at $\leq 20 \text{ R.H.}$ with zip-lock sealed.

3. Baking

It is recommended to baking before soldering when the pack is unsealed after 72hrs. The Conditions are as followings:

3.1 $60 \pm 3^{\circ}\text{C}$ x(12~24hrs) and <math>< 5\% \text{ RH}</math>, taped reel type

3.2 $100 \pm 3^{\circ}\text{C}$ x(45min~1hr), bulk type

3.3 $130 \pm 3^{\circ}\text{C}$ x(15~30min), bulk type

Test items and results of reliability

Type	Test Item	Test Conditions	Note	Number of Damaged
Environmental Sequence	Temperature Cycle	-20°C 30min ↑ ↓ 80°C 30min	100 cycle	0/22
	Thermal Shock	-20°C 15min ↑ ↓ 80°C 15min	100 cycle	0/22
	High Humidity Heat Cycle	30°C ↔ 65°C 90%RH 24hrs/1cycle	10 cycle	0/22
	High Temperature Storage	Ta=80°C	1000 hrs	0/22
	Humidity Heat Storage	Ta=60°C RH=90%	1000 hrs	0/22
	Low Temperature Storage	Ta=-30°C	1000 hrs	0/22
Operation Sequence	Life Test	Ta=25°C IF=20mA	1000 hrs	0/22
	High Humidity Heat Life Test	60°C RH=90% IF=10mA	500 hrs	0/22
	Low Temperature Life Test	Ta=-20°C IF=20mA	1000 hrs	0/22

1706 Series SMD Chip LED Lamps Packaging Specifications

- Feeding Direction

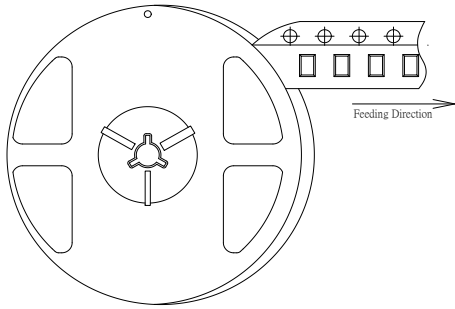

- Dimensions of Reel (Unit: mm)

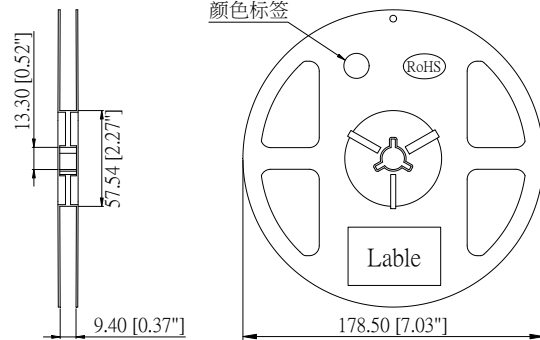

- Dimensions of Tape (Unit: mm)

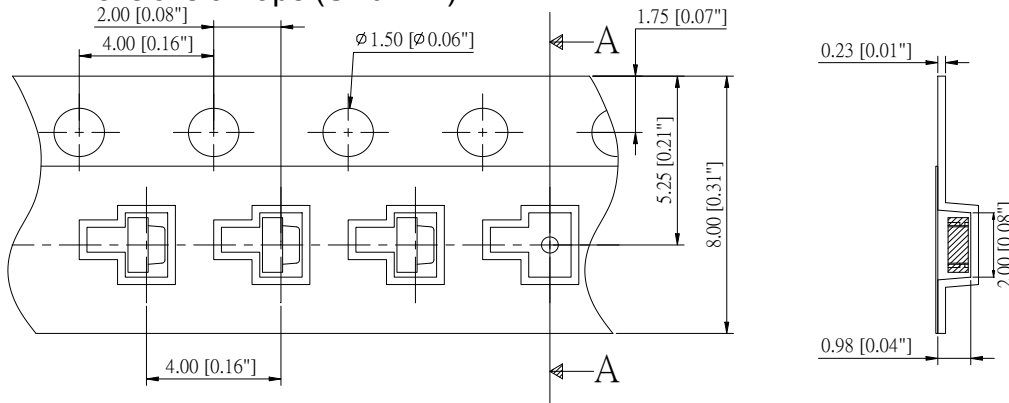

- Arrangement of Tape

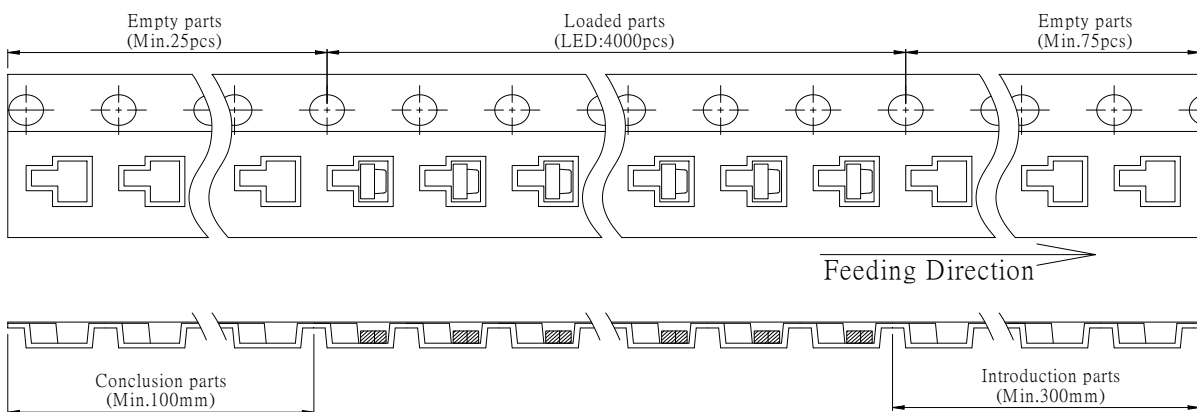

Notes:

1. Empty component pockets are sealed with top cover tape;
2. The maximum number of missing lamps is two;
3. The cathode is oriented towards the tape sprocket hole in accordance with ANSI/EIA RS-481 specifications.
4. 4,000 pcs/Reel.

1706 Series SMD Chip LED Lamps Packaging Specifications

- Packaging specifications

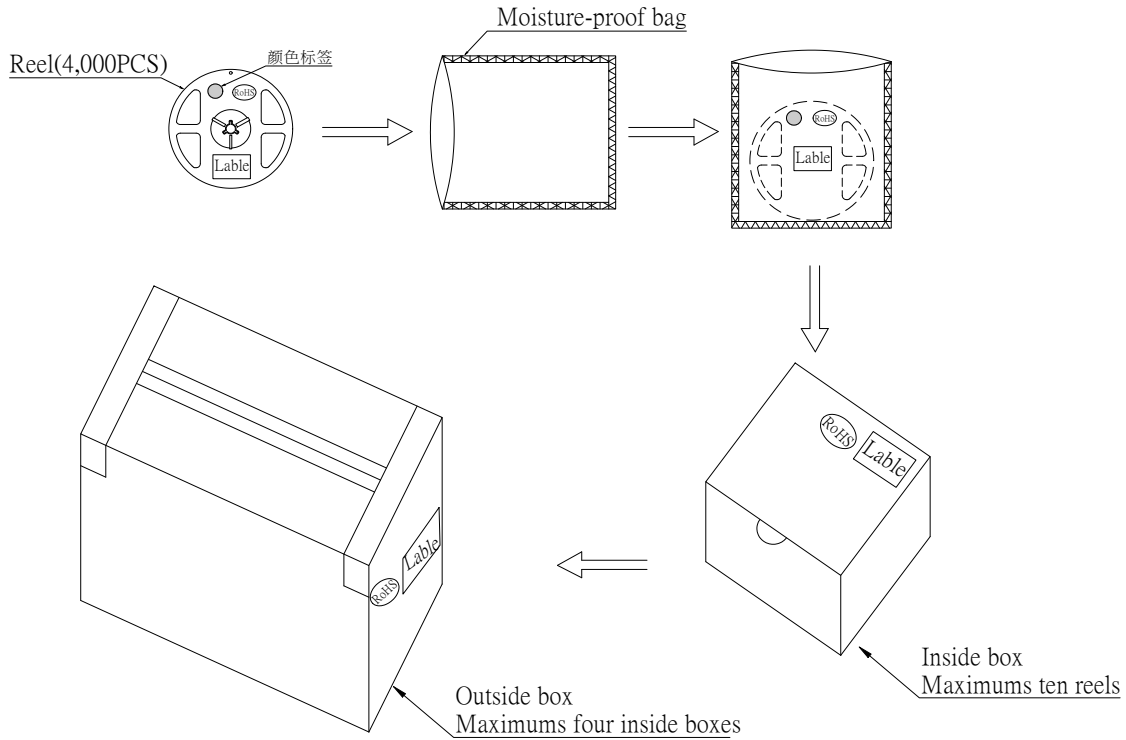

Notes:

Reeled products (numbers of products are 4,000pcs) packed in a seal off moisture-proof bag along with a desiccant one by one, ten moisture-proof bag of maximums (total maximum number of products are 40,000pcs) packed in an inside box (about size: 240x 220x 120mm) and four inside boxes of maximums are put in the outside box (about size: 460mm x 246mm x 250mm) Together with buffer material, and it is packed. (Part No., Lot No., quantity should appear on the label on the moisture-proof bag, part No. and quantity should appear on the label on the cardboard box.) The number of the loading steps of outside box (cardboard box) has it to three steps.