



深圳市首韩科技有限公司

SHENZHEN SHOUHAN TECHNOLOGY CO., LTD

Tel: 0755-27597601 Fax: 0755-27597491

承 认 书
SPECIFICATION FOR APPROVAL

客 户 Customer:

产品名称 Project:

拨动开关

规格型号 Part No:

SS12D07VG5

贵公司承认印 Approval signatures

料 号/Part No.	签 章/Signatures

日期 Date:

拟制/Drawn	李春风	
审核/Check	张栋	
批准/Approved	罗孝金	



SPECIFICATION 规格书

产品名称:拨动开关

产品型号: SS12D07VG5

1:GENERAL SPECIFICATION 基本事项

1.1	RATING (额定值): DC 50V 300mA
1.2	PRACTICAL TEMPERATURE RANEG: - 10°C~+50°C. 使用温度范围: 在-10°C~+50°C温度内使用.
1.3	STANDARD ATMOSPHEIC CONDITIONS : UNLESS OTHERWISE SPECIFIED. THE STANDARD RANGE OF ATMOSPHERIC CONDITIONS FOR MAKING MEASUREMENTS AND TESTS ARE AS FOLLOWS: (1) AMBIENT TEMPERATURE : 5°C TO 35°C; (2) RELATIVE HUMIDITY : 45% TO 85%; (3) AIR PRESSURE : 86Kpa TO 106Kpa. 测试标准状态: 在沒有指定的情況下测试温度, 湿度, 气压如下: (1)温度为5~35°C; (2)湿度为45%~85%; (3) 气压为86Kpa~106Kpa.

2. ELECTRICAL CHARACTERISTICS (电气性能规格):

ITEM 项目	TEST CONDITIONS 测试条件	PERFORMANCE (DATA) 规格(数据)
2.1	CONTACT RESISTANCE 接触电阻 MEASURED AT 1KHz SMALL CURRENT(100 mA OR LESS)在1KHz微小电流(100mA 以下)测试.	50m Ω MAX. 50毫欧以下.
2.2	INSULATION RESISTANCE 绝缘电阻 APPLY A VOLTAGE OF 500V DC FOR 1 MIN. THE FOLLOWING CONTACE TEST METHOD: (1)BETWEEN BODY AND CONDUCTOR. (2) BETWEEN CONDUCTORS NOT TO BE CONTAC. 输入500V DC电压1分钟, 按以下接触方法测试: (1)接触端子之间. (2)胶座体和排脚之间.	100M Ω MIN. 100兆欧以上.
2.3	ELECTRIC STRENGTH 耐电压 AC 500V(50-60Hz) FOR 1 MIN TRIP CURRENT:0.5mA THE FOLLOWING CONTACE TEST METHOD: (1)BETWEEN TERMINALS. (2) BETWEEN INDIVIDUAL TERMINALS AND FRAME. 输入AC500V(50-60Hz) 电压, 1分钟感度电流为0.5mA, 接触测试方法如下: (1)接触端子之间. (2)外壳体和排脚之间.	THOUT DAMAGE TO PARTS ARCING OR BREAKDOWN ETC. 沒有绝缘破坏等异常

3 .MECHANICAL CHARACTERISTICS (机械性能规格):

ITEM 项目	TEST CONDITIONS 测试条件	PERFORMANCE (DATA) 规格(数据)
3.1	OPERATION FORCE 动作力 LATERAL PUSH (侧向推动)	PUSH FORCE (按压力度) :200gf±50gf
3.2	TRAVEL TO CLOSURE 动作行程 IN THE HORIZONTAL DIRECTION SWITCH HANDLE OPRATION, WITH AN EQUAL TO 2TIMES THE THRUST OF THE SWITSH FORM ONE POSITION TO THE NEXT GEAR, MOVING DISTANCE MEASURING HANDLE. 在开关推柄运行的水平方向, 以一个等于2倍推力使开关从一个档位运动到下一档位, 测量推柄的移动距离.	2mm±0.2mm
3.3	STEM STRENGTH 操作部(柄)强度 AND ALONG THE RUNNING DIRECTION AT APEX HANDLE(500gf) ON THESTRENGTH TEST, TIME IS 30SECONDS. 在推柄的先端沿运行方向加上(500gf)力度测试, 时间为30秒.	THERE SHALL BE NO DAMAGE ONAPPEARANCE MECHANICAL AND ELECTRICAL CHARACTERISTICS SHALL BE SATISFIED 外观无异常, 满足于机械, 电气性能



产品名称: 拨动开关

产品型号: SS12D07VG5

4. DURABILITY(耐久性) :

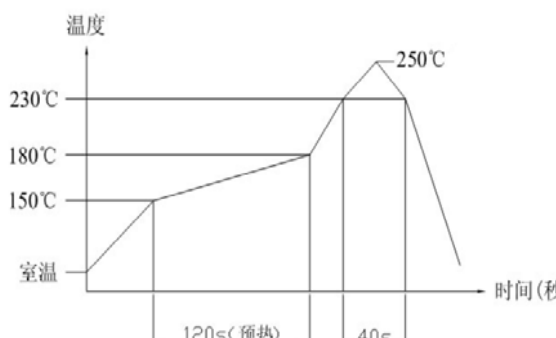
ITEM 项目		TEST CONDITIONS 测试条件	PERFORMANCE (DATA) 规格(数据)
4.1	LIFE TEST 寿命试验	AN ACTUATOR SHALL BE WITH A THRUST OF NO GREAT THAN 1 TIMES SWITH POWER TO 5000 CYCLES AT A SPEED OF 30 CYCLES FOR 1 MIN. 操作者以每分钟30次的频率, 施加不大于开关1倍的推力做 5000 次无负荷测试.	1) CONTACT RESISTANCE SHALL BE 500mΩ MAX. 2) LIFETIME: 5000次 1) 接触电阻不超于500mΩ. 2) 寿命: 5000次
4.2	HEAT TEST 耐热实验	THE SWITCH SHALL BE STORED AT A TEMPERATURE OF 85±2°C FOR 96 HOURS. AND THEN IT SHALL BE SUBJECTED TO THE CONTROLLED RECOVERY CONDITIONS FOR 1 HOUR AFTER WHICH MEASUREMENT SHALL BE MADE. 放置在温度85±2°C中96小时后, 再放置正常室温 中1小时后测定.	THERE SHALL BE NO DAMAGE ONAPPEARANCE MECHANICAL AND ELECTRICAL CHARACTERISTICS SHALL BE SATISFIED 外观无异常, 满足于机械, 电气性能
4.3	COLD TEST 耐冷实验	THE SWITCH SHALL BE STORED AT A TEMPERATURE OF-25±3°C FOR 96 HOURS. AND THEN IT SHALL BE SUBJECTED TO THE CONTROLLED RECOVERY CONDITIONS FOR 1 HOUR AFTER WHICH MEASUREMENT SHALL BE MADE. 放置在温度-25±3°C中96小时后, 再放置正常室温 中1小时后测定.	
4.4	HUMIDITY TEST 潮湿实验	THE SWITCH SHALL BE STORED AT A TEMPERATURE OF 40±2°C AND A HUMIDITY OF 80% TO 85% FOR 96 Hr. THEN THE JACK SHALL BE MAINTAINEDAT STANDARD ATMOSPHERIC CONDITION FOR 1 Hr FOR OTHER PROCEDURES. 放置在40±2°C相对湿度为80~85%环境中96小时后, 再将样品放在正常室温中1小时后测定.	
4.5	SOLDERING CONDITIONS 焊锡条件	HAND SOLDERING 手焊: 1) DIVCE 工具: SOLDER IRON 电烙铁. A. 350°C MAX. , 2 sec Max B. 270°C MAX. , 4 sec Max 2) REFLOW SOLDERING 回流焊: ≤250°C 	THERE SHALL BE NO DAMAGE ONAPPEARANCE MECHANICAL AND ELECTRICAL CHARACTERISTICS SHALL BE SATISFIED 外观无异常, 满足于机械, 电气性能

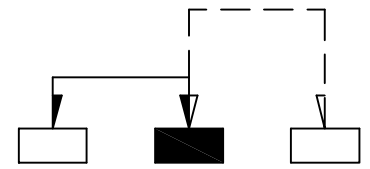
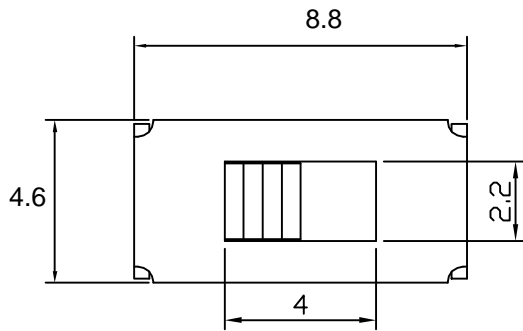

SCHEMATIC

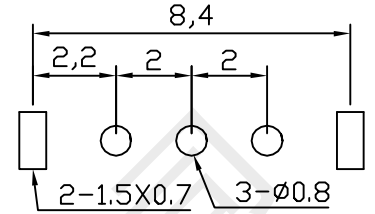

PCB LAYOUT

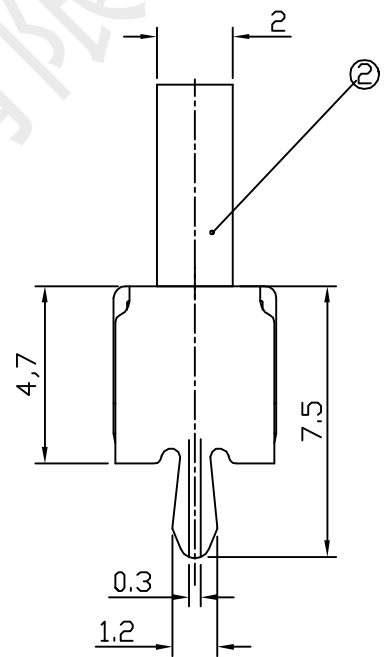
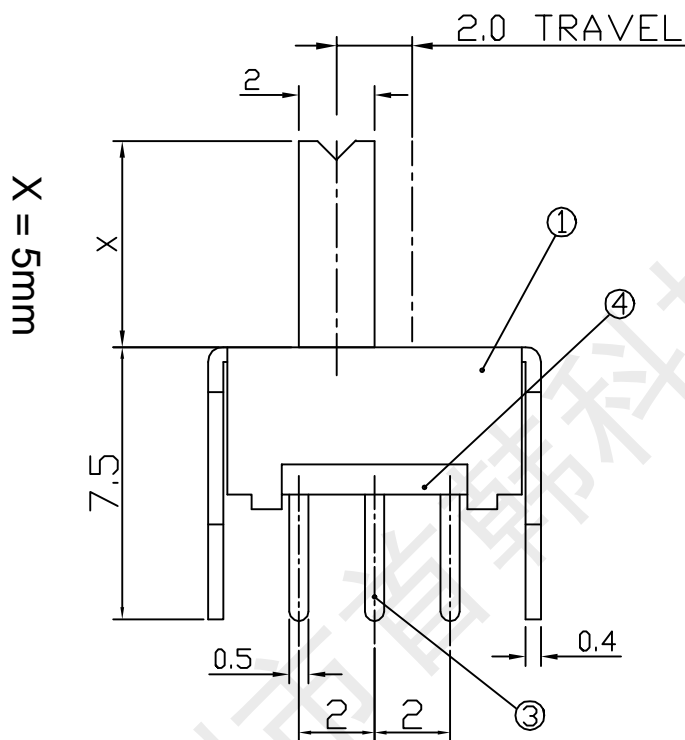

NO	PART	MATERIAL	QTY	FINISHING	NO	PART	MATERIAL	QTY	FINISHING
1	FRAME	C R S	1	NI PLATED	4	TERMINAL BASE	PHENOL RESIN	1	NATURAL
2	KNOB	P O M	1	BLACK	5	CONTACT	B S P	1	AG PLATED
3	TERMINAL	B S P	3	AG PLATED					

ISSUED	SPECIFICATION	TITLE: SLIDE SWITCH		
	RATING: DC 50V 0.3A	MODEL NO: SS12D07VG5		
	CONTACT RESISTANCE: 50m ohm max	UNIT: mm	DWN	李春风
	INSULATION RESISTANCE: 100M ohm at 500V DC	SCALE: 4:1	CHK'D	张栋
	WITHSTAND VOLTAGE: AC 500V for 1 minute	TOLERANCE: 0.1mm	APPD	罗孝金
	SWITCHING LIFE:			
	VERSION: 第 2 版	DATE: 2017年2月15日		