

## N-channel 600 V, 0.13 $\Omega$ typ., 21 A MDmesh™ DM2 Power MOSFET in a TO-220FP package

Datasheet - production data

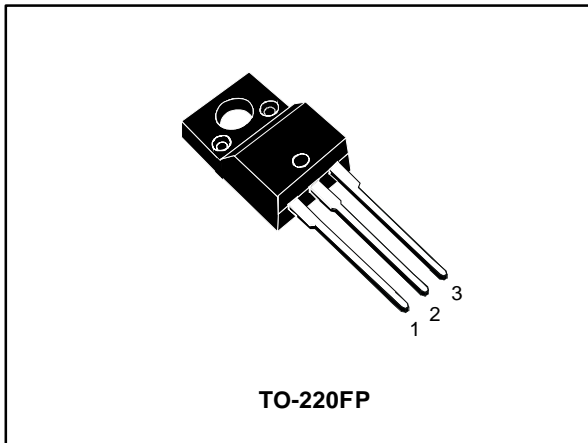
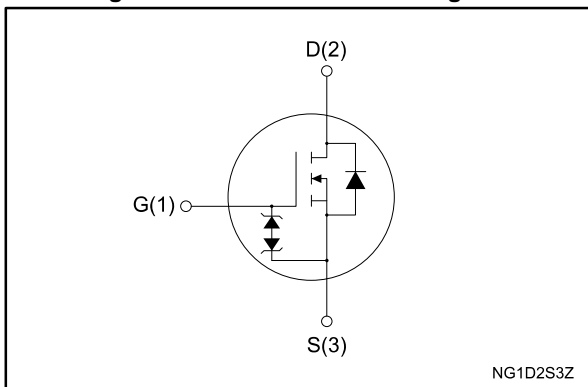

Figure 1: Internal schematic diagram



### Features

Order code	$V_{DS}$ @ $T_{Jmax.}$	$R_{DS(on)}$ max.	$I_D$	$P_{TOT}$
STF28N60DM2	650 V	0.16 $\Omega$	21 A	30 W

- Fast-recovery body diode
- Extremely low gate charge and input capacitance
- Low on-resistance
- 100% avalanche tested
- Extremely high dv/dt ruggedness
- Zener-protected

### Applications

- Switching applications

### Description

This high voltage N-channel Power MOSFET is part of the MDmesh™ DM2 fast recovery diode series. It offers very low recovery charge ( $Q_{rr}$ ) and time ( $t_{rr}$ ) combined with low  $R_{DS(on)}$ , rendering it suitable for the most demanding high efficiency converters and ideal for bridge topologies and ZVS phase-shift converters.

Table 1: Device summary

Order code	Marking	Package	Packing
STF28N60DM2	28N60DM2	TO-220FP	Tube

---

## Contents

<b>1</b>	<b>Electrical ratings .....</b>	<b>3</b>
<b>2</b>	<b>Electrical characteristics .....</b>	<b>4</b>
	2.1 Electrical characteristics (curves) .....	6
<b>3</b>	<b>Test circuits .....</b>	<b>8</b>
<b>4</b>	<b>Package information .....</b>	<b>9</b>
	4.1 TO-220FP package information .....	9
<b>5</b>	<b>Revision history .....</b>	<b>11</b>

# 1 Electrical ratings

**Table 2: Absolute maximum ratings**

Symbol	Parameter	Value	Unit
$V_{GS}$	Gate-source voltage	$\pm 25$	V
$I_D$	Drain current (continuous) at $T_{case} = 25\text{ }^\circ\text{C}$	21	A
	Drain current (continuous) at $T_{case} = 100\text{ }^\circ\text{C}$	14	
$I_{DM}^{(1)}$	Drain current (pulsed)	84	A
$P_{TOT}$	Total dissipation at $T_{case} = 25\text{ }^\circ\text{C}$	30	W
$dv/dt^{(2)}$	Peak diode recovery voltage slope	50	V/ns
$dv/dt^{(3)}$	MOSFET $dv/dt$ ruggedness	50	
$V_{ISO}^{(4)}$	Insulation withstand voltage (RMS) from all three leads to external heat sink	2.5	kV
$T_{stg}$	Storage temperature	-55 to 150	$^\circ\text{C}$
$T_j$	Operating junction temperature		

**Notes:**

- (1) Pulse width is limited by safe operating area.  
 (2)  $I_{SD} \leq 21\text{ A}$ ,  $di/dt=900\text{ A}/\mu\text{s}$ ;  $V_{DS\text{ peak}} < V_{(BR)DSS}$ ,  $V_{DD} = 400\text{ V}$   
 (3)  $V_{DS} \leq 480\text{ V}$ .  
 (4)  $t = 1\text{ s}$ ;  $T_C = 25\text{ }^\circ\text{C}$

**Table 3: Thermal data**

Symbol	Parameter	Value	Unit
$R_{thj-case}$	Thermal resistance junction-case	4.2	$^\circ\text{C}/\text{W}$
$R_{thj-amb}$	Thermal resistance junction-ambient	62.5	

**Table 4: Avalanche characteristics**

Symbol	Parameter	Value	Unit
$I_{AR}^{(1)}$	Avalanche current, repetitive or not repetitive	4	A
$E_{AS}^{(2)}$	Single pulse avalanche energy	350	mJ

**Notes:**

- (1) pulse width limited by  $T_{jmax}$   
 (2) starting  $T_j = 25\text{ }^\circ\text{C}$ ,  $I_D = I_{AR}$ ,  $V_{DD} = 50\text{ V}$ .

## 2 Electrical characteristics

( $T_{\text{case}} = 25\text{ °C}$  unless otherwise specified)

**Table 5: Static**

Symbol	Parameter	Test conditions	Min.	Typ.	Max.	Unit
$V_{(\text{BR})\text{DSS}}$	Drain-source breakdown voltage	$V_{\text{GS}} = 0\text{ V}$ , $I_{\text{D}} = 1\text{ mA}$	600			V
$I_{\text{DSS}}$	Zero gate voltage drain current	$V_{\text{GS}} = 0\text{ V}$ , $V_{\text{DS}} = 600\text{ V}$			1	$\mu\text{A}$
		$V_{\text{GS}} = 0\text{ V}$ , $V_{\text{DS}} = 600\text{ V}$ , $T_{\text{case}} = 125\text{ °C}$			100	
$I_{\text{GSS}}$	Gate-body leakage current	$V_{\text{DS}} = 0\text{ V}$ , $V_{\text{GS}} = \pm 25\text{ V}$			$\pm 10$	$\mu\text{A}$
$V_{\text{GS}(\text{th})}$	Gate threshold voltage	$V_{\text{DS}} = V_{\text{GS}}$ , $I_{\text{D}} = 250\text{ }\mu\text{A}$	3	4	5	V
$R_{\text{DS}(\text{on})}$	Static drain-source on-resistance	$V_{\text{GS}} = 10\text{ V}$ , $I_{\text{D}} = 10.5\text{ A}$		0.13	0.16	$\Omega$

**Table 6: Dynamic**

Symbol	Parameter	Test conditions	Min.	Typ.	Max.	Unit
$C_{\text{iss}}$	Input capacitance	$V_{\text{DS}} = 100\text{ V}$ , $f = 1\text{ MHz}$ , $V_{\text{GS}} = 0\text{ V}$	-	1500	-	$\text{pF}$
$C_{\text{oss}}$	Output capacitance		-	70	-	
$C_{\text{rss}}$	Reverse transfer capacitance		-	1.6	-	
$C_{\text{oss eq.}}^{(1)}$	Equivalent output capacitance	$V_{\text{DS}} = 0\text{ to }480\text{ V}$ , $V_{\text{GS}} = 0\text{ V}$	-	134	-	$\text{pF}$
$R_{\text{G}}$	Intrinsic gate resistance	$f = 1\text{ MHz}$ , $I_{\text{D}} = 0\text{ A}$	-	4.6	-	$\Omega$
$Q_{\text{g}}$	Total gate charge	$V_{\text{DD}} = 480\text{ V}$ , $I_{\text{D}} = 21\text{ A}$ , $V_{\text{GS}} = 10\text{ V}$ (see <a href="#">Figure 15: "Test circuit for gate charge behavior"</a> )	-	34	-	$\text{nC}$
$Q_{\text{gs}}$	Gate-source charge		-	8	-	
$Q_{\text{gd}}$	Gate-drain charge		-	18.5	-	

**Notes:**

<sup>(1)</sup>  $C_{\text{oss eq.}}$  is defined as a constant equivalent capacitance giving the same charging time as  $C_{\text{oss}}$  when  $V_{\text{DS}}$  increases from 0 to 80%  $V_{\text{DSS}}$ .

**Table 7: Switching times**

Symbol	Parameter	Test conditions	Min.	Typ.	Max.	Unit
$t_{\text{d}(\text{on})}$	Turn-on delay time	$V_{\text{DD}} = 300\text{ V}$ , $I_{\text{D}} = 10.5\text{ A}$ $R_{\text{G}} = 4.7\text{ }\Omega$ , $V_{\text{GS}} = 10\text{ V}$ (see <a href="#">Figure 14: "Test circuit for resistive load switching times"</a> and <a href="#">Figure 19: "Switching time waveform"</a> )	-	16	-	$\text{ns}$
$t_{\text{r}}$	Rise time		-	7.3	-	
$t_{\text{d}(\text{off})}$	Turn-off delay time		-	53	-	
$t_{\text{f}}$	Fall time		-	9.3	-	

Table 8: Source-drain diode

Symbol	Parameter	Test conditions	Min.	Typ.	Max.	Unit
$I_{SD}^{(1)}$	Source-drain current		-		21	A
$I_{SDM}^{(2)}$	Source-drain current (pulsed)		-		84	A
$V_{SD}^{(3)}$	Forward on voltage	$V_{GS} = 0 \text{ V}$ , $I_{SD} = 21 \text{ A}$	-		1.6	V
$t_{rr}$	Reverse recovery time	$I_{SD} = 21 \text{ A}$ , $di/dt = 100 \text{ A}/\mu\text{s}$ , $V_{DD} = 60 \text{ V}$ (see <a href="#">Figure 16</a> : "Test circuit for inductive load switching and diode recovery times")	-	140		ns
$Q_{rr}$	Reverse recovery charge		-	0.5		$\mu\text{C}$
$I_{RRM}$	Reverse recovery current		-	7.4		A
$t_{rr}$	Reverse recovery time	$I_{SD} = 21 \text{ A}$ , $di/dt = 100 \text{ A}/\mu\text{s}$ , $V_{DD} = 60 \text{ V}$ , $T_j = 150 \text{ }^\circ\text{C}$ (see <a href="#">Figure 16</a> : "Test circuit for inductive load switching and diode recovery times")	-	309		ns
$Q_{rr}$	Reverse recovery charge		-	2.6		$\mu\text{C}$
$I_{RRM}$	Reverse recovery current		-	16.8		A

**Notes:**

- (1) Limited by maximum junction temperature.  
(2) Pulse width is limited by safe operating area.  
(3) Pulse test: pulse duration = 300  $\mu\text{s}$ , duty cycle 1.5%.

Table 9: Gate-source Zener diode

Symbol	Parameter	Test conditions	Min.	Typ.	Max.	Unit
$V_{(BR)GSO}$	Gate-source breakdown voltage	$I_{GS} = \pm 250 \mu\text{A}$ , $I_D = 0 \text{ A}$	$\pm 30$	-	-	V

The built-in back-to-back Zener diodes are specifically designed to enhance the ESD performance of the device. The Zener voltage facilitates efficient and cost-effective device integrity protection, thus eliminating the need for additional external componentry.

## 2.1 Electrical characteristics (curves)

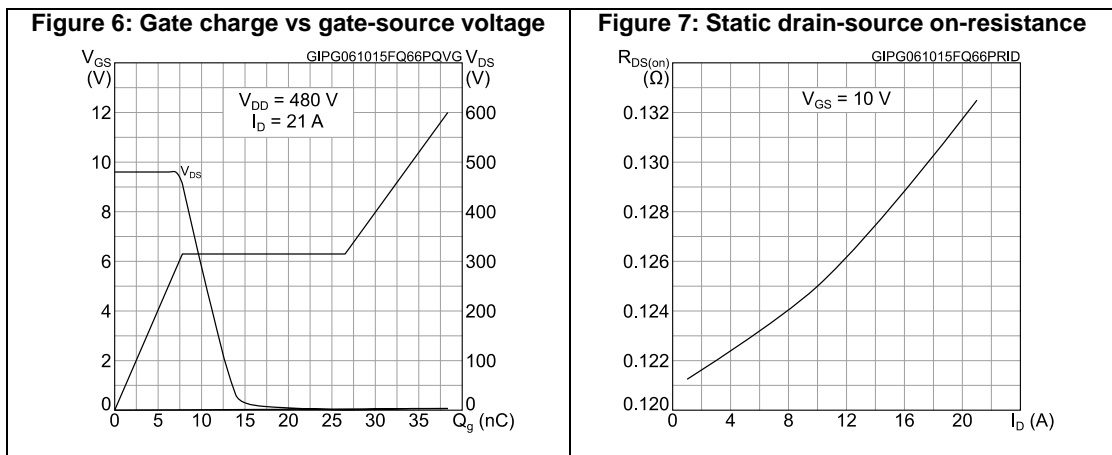
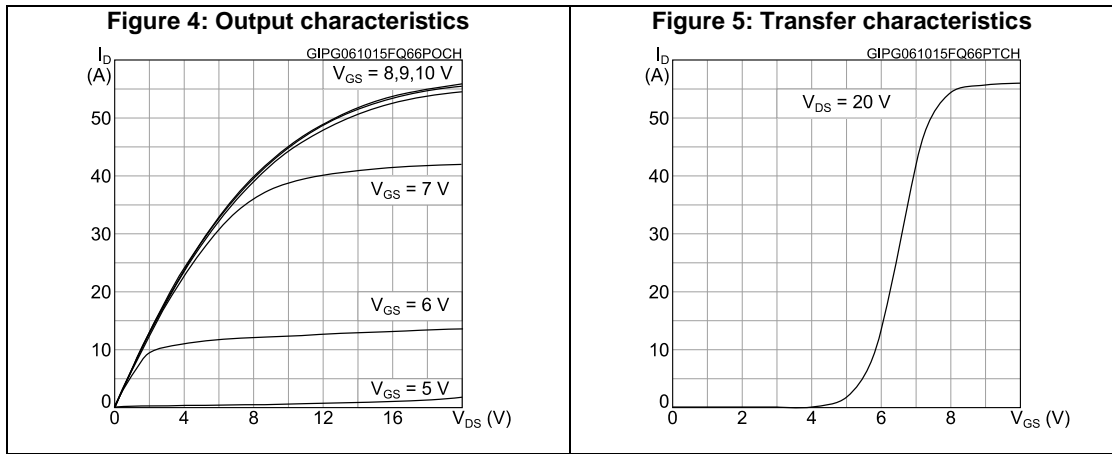
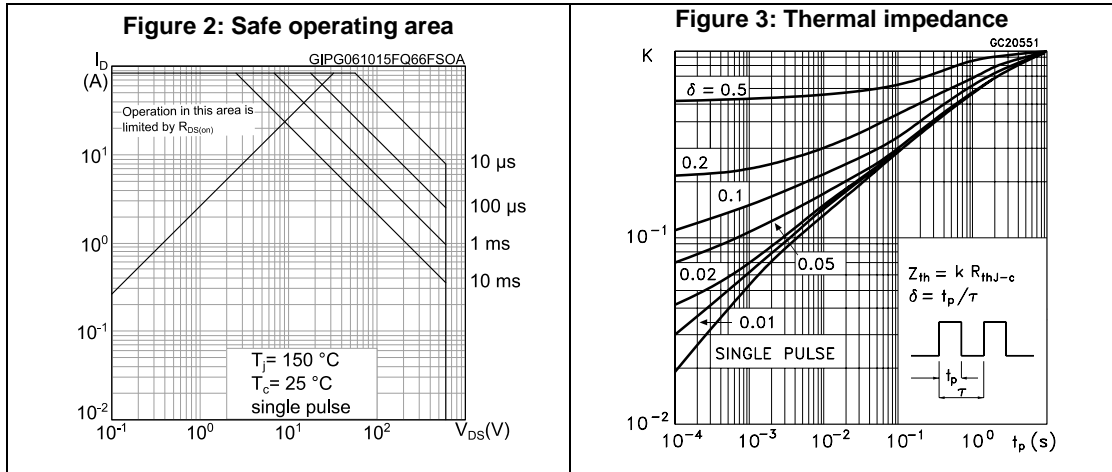

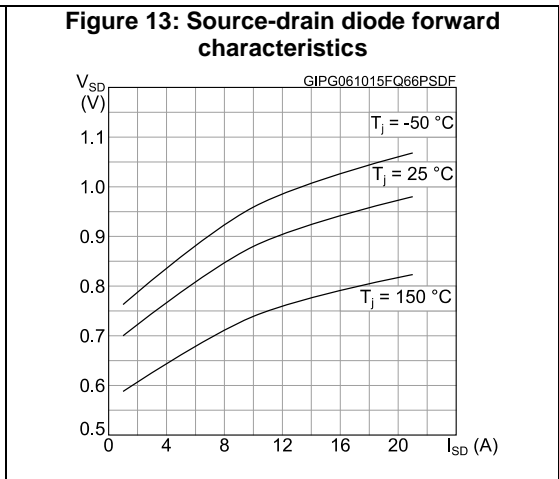
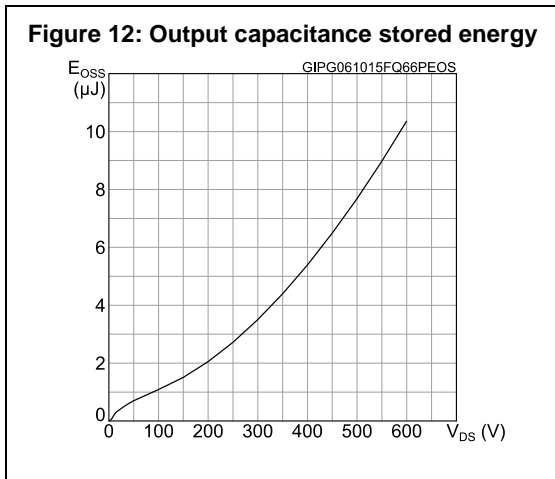
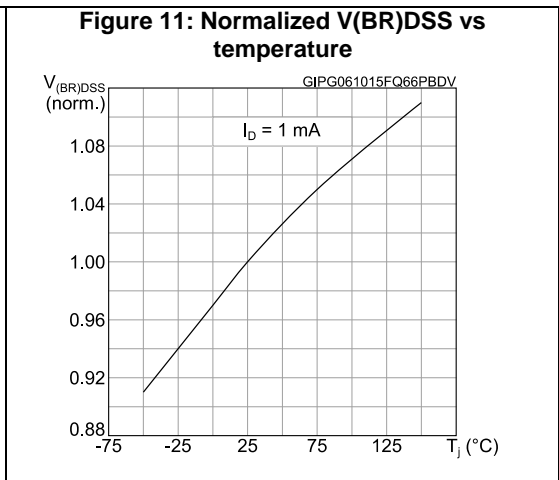
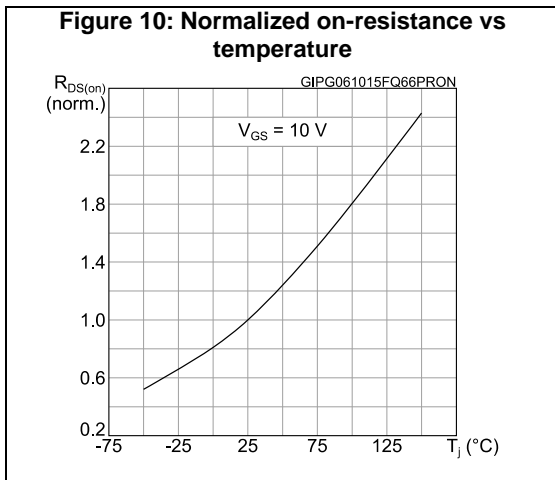
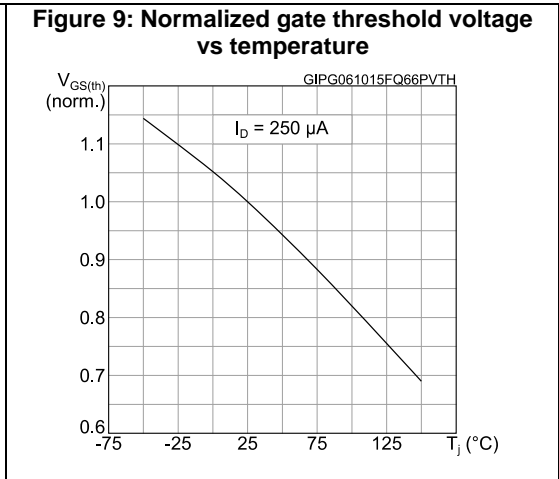
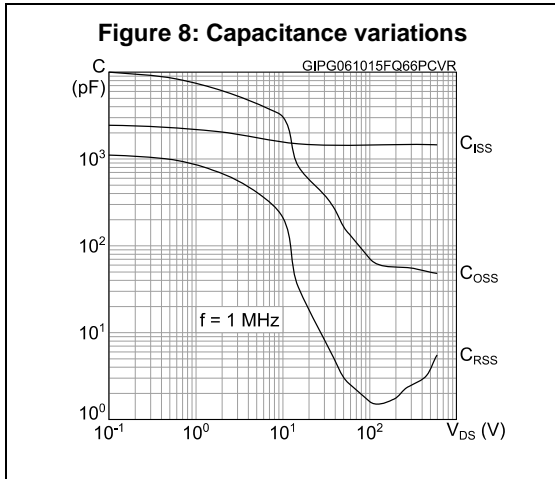

### 3 Test circuits

**Figure 14: Test circuit for resistive load switching times**

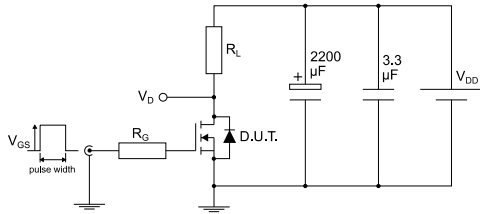

AM01468v1

**Figure 15: Test circuit for gate charge behavior**

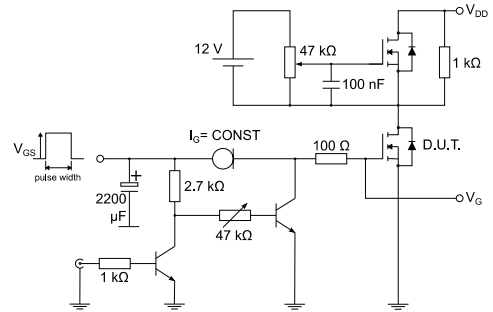

AM01469v1

**Figure 16: Test circuit for inductive load switching and diode recovery times**

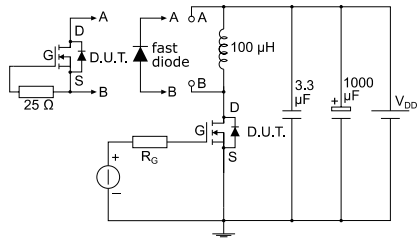

AM01470v1

**Figure 17: Unclamped inductive load test circuit**

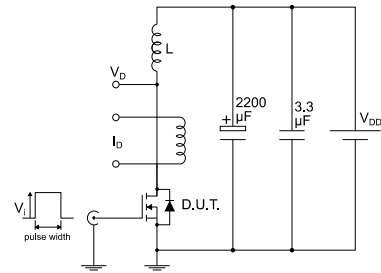

AM01471v1

**Figure 18: Unclamped inductive waveform**

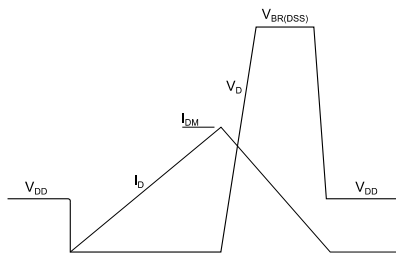

AM01472v1

**Figure 19: Switching time waveform**

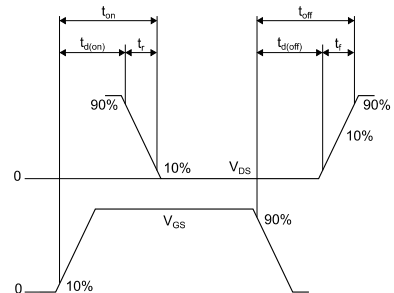

AM01473v1



## 4 Package information

In order to meet environmental requirements, ST offers these devices in different grades of ECOPACK® packages, depending on their level of environmental compliance. ECOPACK® specifications, grade definitions and product status are available at: [www.st.com](http://www.st.com). ECOPACK® is an ST trademark.

### 4.1 TO-220FP package information

Figure 20: TO-220FP package outline

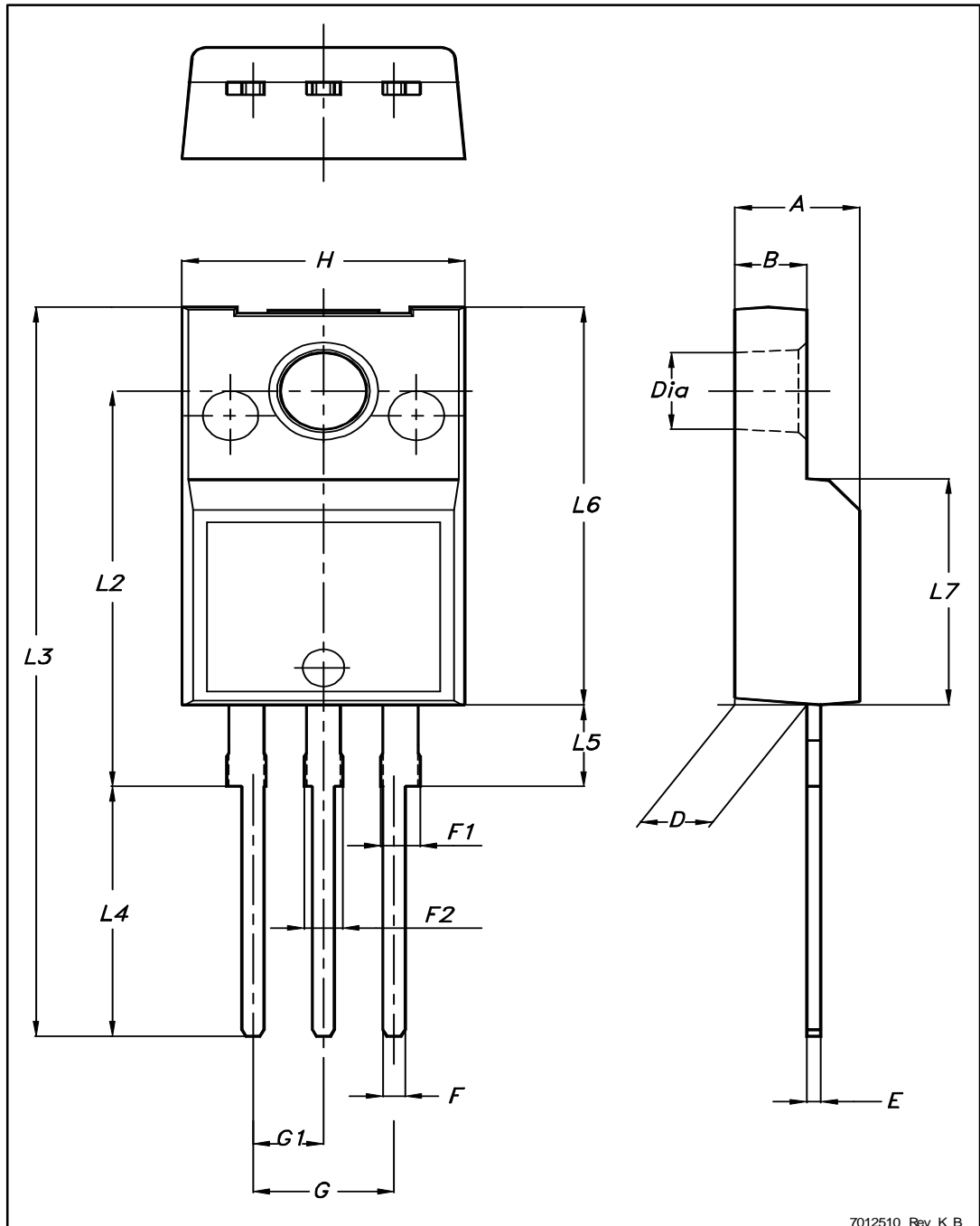

Table 10: TO-220FP package mechanical data

Dim.	mm		
	Min.	Typ.	Max.
A	4.4		4.6
B	2.5		2.7
D	2.5		2.75
E	0.45		0.7
F	0.75		1
F1	1.15		1.70
F2	1.15		1.70
G	4.95		5.2
G1	2.4		2.7
H	10		10.4
L2		16	
L3	28.6		30.6
L4	9.8		10.6
L5	2.9		3.6
L6	15.9		16.4
L7	9		9.3
Dia	3		3.2

## 5 Revision history

**Table 11: Document revision history**

Date	Revision	Changes
04-Sep-2014	1	First release.
09-Oct-2015	2	Text and formatting changes throughout document On cover page: - updated title and Features table In section Electrical ratings: - updated all table data In section Electrical characteristics: - updated all table data - renamed table Static (was On /off states) - added table Gate-source Zener diode Added section Electrical characteristics (curves) Updated and renamed section Package mechanical data (was Package information) Datasheet promoted from preliminary to production data

**IMPORTANT NOTICE – PLEASE READ CAREFULLY**

STMicroelectronics NV and its subsidiaries ("ST") reserve the right to make changes, corrections, enhancements, modifications, and improvements to ST products and/or to this document at any time without notice. Purchasers should obtain the latest relevant information on ST products before placing orders. ST products are sold pursuant to ST's terms and conditions of sale in place at the time of order acknowledgement.

Purchasers are solely responsible for the choice, selection, and use of ST products and ST assumes no liability for application assistance or the design of Purchasers' products.

No license, express or implied, to any intellectual property right is granted by ST herein.

Resale of ST products with provisions different from the information set forth herein shall void any warranty granted by ST for such product.

ST and the ST logo are trademarks of ST. All other product or service names are the property of their respective owners.

Information in this document supersedes and replaces information previously supplied in any prior versions of this document.

© 2015 STMicroelectronics – All rights reserved