

ELECTRICAL	Single shaft (R1)
1. Total resistance:	20 kΩ ± 20%
2. Rated power:	0.05W
3. Rated voltage:	Please refer to the attached.
4. Resistance taper:	Please refer to the attached.
5. Tap position:	_____
6. Tap resistance between terminals:	_____
7. Residual resistance between terminals:	1&2, 2&3 : 30Ω max.
8. Sliding noise : (Measured by JIS C 6443)	Less than 100mV
9. Insulation resistance :	More than 100 MΩ at 250V D.C.
10. Withstand voltage:	300V A.C. for 1 minute.
11. Gang error :	_____
12. switch rating:(Resistor load)	3A 16V D.C. (min:10mA)
13. Switch contact resistance: (Measured by the 1A 5V D.C. voltage drop method.)	Initial value :100mΩ max. After 10,000 cycles:200mΩ max.
14. Circuit:	_____

MECHANICAL	
1. Total rotational angle :	300° ± 5°
2. Rotational torque: (Rotational speed 60°/sec.)	2~25mN·m.
3. Stopper strength :	No damage with an application of 0.5N·m min.
4. Resistance to soldering heat :	Please refer to the attached.
5. Bushing nut tightening strength :	Tightening torque to be no greater than 1N·m. *Pay attention otherwise the strength may not be assured.
6. Push / pull strength :	No damages with an application of Push or pull force 100N for 10 sec.
7. Shaft wobble :(Apply the moment of 50mN·m at the point of 30mm from mounting surface)	0.6 XL/30mm p-p max. (L:Shaft length) (If the shaft length is less than 30mm, the value shall be calculated proportionally.)
8. Operation force of shaft:	_____
9. Click position :	_____
10. Click torque:	_____
11. Rotation play at the click position:	_____
12. Contact arrangement :	S. P. S. T.
13. Switching angle :	50° max.
14. Switch operation torque :	50mN·m max.

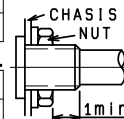

ENDURANCE	
1. Rotational life :	More than 15,000 cycles.
2. Switching life :	More than 10,000 cycles.

NOTES

- The items except above mentioned items shall meet or exceed JIS C 6443.
- This type is protected against sulfides.
- Operating temperature range : -20°C to +70°C
- Storage temperature range : -40°C to +85°C

<b>ALPSALPINE CO.,LTD.</b>	TITLE						APPD. May. 05. '94 R. Arasawa	CHKD. May. 05. '94 M. Endo	DSGD. May. 05. '94 T. Yamaguti	No. V R 0 0 0 0 0 1 3
	SPECIFICATIONS	SYMB	DATE	APPD	CHKD	DSGD				

# ALPSALPINE CO., LTD.

## Rated voltage :

The rated voltage shall be the voltage of D. C. or A. C. (commercial frequency, effective value) corresponding to the rated power (dissipation), and be obtained from the following formula. When the obtained rated voltage exceeds the maximum working voltage given in the following, however, the maximum working voltage of the following shall be the rated voltage.

$$E = \sqrt{P \cdot R} \text{ (V)}$$

Where E : Rated voltage (V)  
P : Rated power (dissipation) (W)  
R : Nominal total resistance ( $\Omega$ )

Maximum working voltage : 50 V A. C. , 30 V D. C.

## Resistance to soldering heat

There shall be no evidence of poor contact between resistance element and terminals, or any physical damages as a result of soldering.

### • Dip soldering

Condition of soldering :  
Soldering shall be certified with following condition.  
Substrate to be soldered :  
Copper clad laminated phenol board in one surface of 1.6 mm thickness.  
Solder flux :  
Flux of 0.82 specific weight in bubbling type solder fluxcoating apparatus shall be used and bubbling surface height shall be defined substantially as half thickness of substrate.  
Flux shall not flow up on substrate surface.  
Preheating :  
Surface temperature of substrate shall be settled within 100°C in 2 minutes.  
Dip soldering :  
To be performed in 260±5°C . 5±1 sec.

Please use the above process only 1 or 2 times.

### • Manual soldering

To be performed in 3 seconds within 350°C.

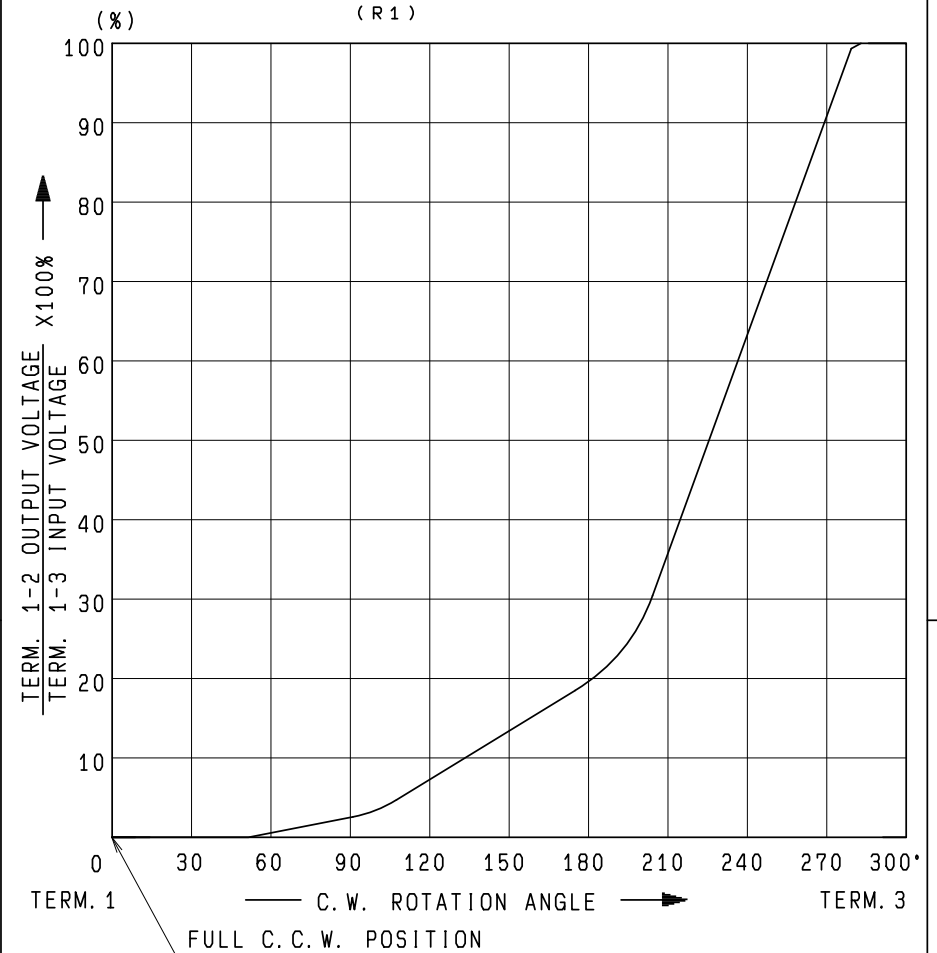

AT 170° C.W. SHAFT ROTATION FROM FULL C.C.W. POSITION VOLTAGE PERCENT SHALL FALL WITHIN THE LIMITS OF 10-25 PERCENT.

SYMB	DATE	APPD	CHKD	DSGD	APPD.	CHKD.	DSGD.	NAME
					May. 23. '94	May. 23. '94	May. 23. '94	
					R. Arasawa	M. Endo	T. Yamaguti	
					DOCUMENT NO.			

**Confidential**

SYMB	DATE	APPD	CHKD	DSGD	APPD.	CHKD.	DSGD.	NAME
					May. 23. '94	May. 23. '94	May. 23. '94	K09-A13
					K. Nagami	S. Sasaki	K. Suzuki	RESISTANCE TAPER
					DOCUMENT NO. VR00000013			

**Confidential**

NOTES  
 BUSHING MATERIAL ----- ZINC ALLOY DIE CASTING  
 SHAFT MATERIAL ----- ALUMINUM

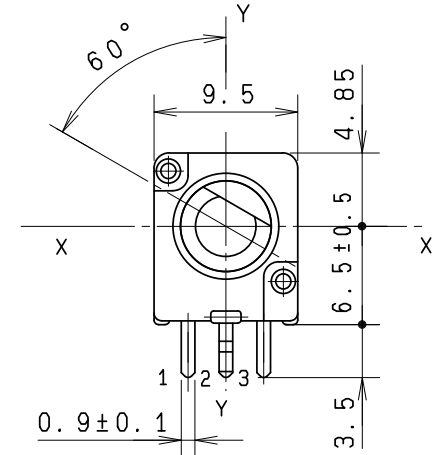
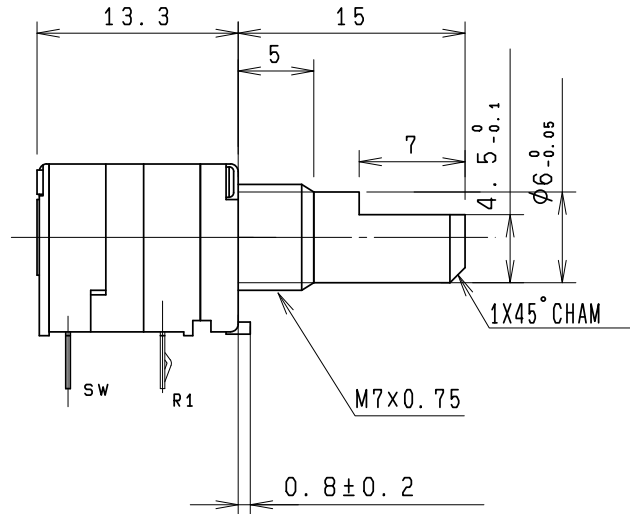

LOCATING LUG DETAIL  
 シャーシ止め詳細図

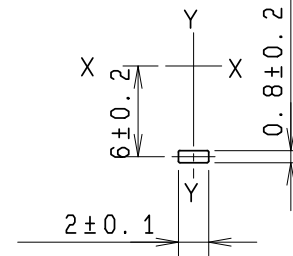

上図は軸を反時計方向に  
 回し切った状態を示す。  
 SHAFT SHOWN IN  
 FULL CCW POSITION

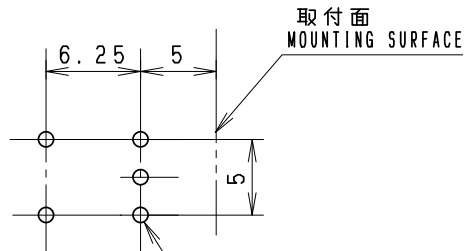

端子取付穴寸法図 (挿入側より見た図)  
 (許容差±0.1) 5 - φ1<sup>+0.1</sup> 穴 HOLES

MOUNTING HOLE DETAIL  
 (TOLERANCE±0.1)  
 VIEWED FROM  
 MOUNTING SIDE

重量 4.4g

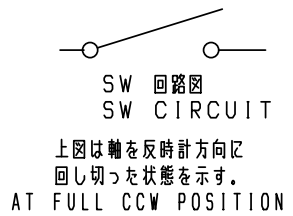

指定なき部分の許容差 TOLERANCES UNLESS OTHERWISE SPEC	
L ≤ 10	±0.3
10 < L < 100	±0.5
100 ≤ L	±0.8
角度 ANGULAR DIMENSION	±5°

SYMB	DATE	APPD	CHKD	DSGD

# ALPSALPINE CO., LTD.

DSGN. 第1製品部 設計1課 T, YAMAGUTI '94-05-23	SCALE X	VR00000013
CHKD. M, ENDO '94-05-23	TITLE 9形1軸単速 ロ-タリSW付VR 組立図	
APPD. R, ARASAWA '94-05-23	UNIT m m	DOCUMENT NO. K091K1002

**Confidential**