

SMFxxxA(CA) Series

Features

- Peak power dissipation 200W @10 x 1000 us Pulse
- Low profile package.
- Excellent clamping capability.
- Glass passivated junction.
- Fast response time: typically less than 1ns from 0 Volts to BV min
- Typical IR less than 1uA when VBR min above 15V.
- IEC 61000-4-2 ESD 30KV(Air), 30KV(Contact)
- ESD protection of data lines in accordance with IEC 61000-4-2
- EFT protection of data lines in accordance with IEC 61000-4-4



Mechanical Characteristics

- CASE: SOD-123FL Molded Plastic over glass passivated junction.
- Mounting Position: Any
- Polarity: by cathode band denotes uni-directional device,
None cathode band denotes bi-directional device.
- Terminal: Solder plated
- Halogen free and RoHS compliant
- Lead-free finish

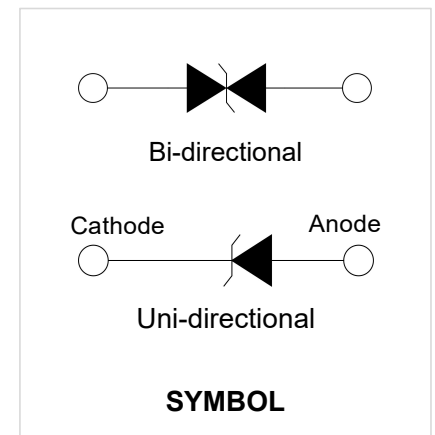

Absolute Maximum Ratings (TA=25°C, RH=45%-75%, unless otherwise noted)

Parameter	Symbol	Value	Unit
Operating Temperature Range	T _J	-55 to +150	°C
Storage Temperature Range	T _{STG}	-55 to +175	°C
Steady state power dissipation at T _L =75°C	P _{M(AV)}	0.5	W
Peak pulse power dissipation on 10/1000µs waveform	P _{PP}	200	W
Maximum instantaneous forward voltage at 20A for unidirectional	V _F	3.5	V
Peak forward surge current, 8.3ms single half sine wave ^a	I _{FSM}	20	A
Typical thermal resistance junction to lead	R _{θJL}	100	°C/W
Typical thermal resistance junction to ambient	R _{θJA}	220	°C/W

Notes:

a. Measured on 8.3ms single half sine wave or equivalent square wave for unidirectional device only, duty cycle=4 per minute maximum

SMFxxxA(CA) Series

Electrical Characteristics (TA = 25°C unless otherwise noted)

Type Number		Marking		Reverse Stand-Off Voltage	Breakdown Voltage Min. @IT	Breakdown Voltage Max. @IT	Test Current	Maximum Clamping Voltage@IPP	Maximum Peak Pulse Current	Reverse Leakage @VRMW
Uni	Bi	Uni	Bi	VRMW(V)	VBR MIN(V)	VBR MAX(V)	IT (mA)	Vc(V)	IPP(A)	IR(uA)
SMF5.0A	SMF5.0CA	5.0A	5.0CA	5.0	6.40	7.00	10	9.2	21.7	400.0
SMF6.0A	SMF6.0CA	6.0A	6.0CA	6.0	6.67	7.37	10	10.3	19.4	400.0
SMF6.5A	SMF6.5CA	6.5A	6.5CA	6.5	7.22	7.98	10	11.2	17.9	250.0
SMF7.0A	SMF7.0CA	7.0A	7.0CA	7.0	7.78	8.60	10	12.0	16.7	100.0
SMF7.5A	SMF7.5CA	7.5A	7.5CA	7.5	8.33	9.21	1	12.9	15.5	50.0
SMF8.0A	SMF8.0CA	8.0A	8.0CA	8.0	8.89	9.83	1	13.6	14.7	25.0
SMF8.5A	SMF8.5CA	8.5A	8.5CA	8.5	9.44	10.40	1	14.4	13.9	10.0
SMF9.0A	SMF9.0CA	9.0A	9.0CA	9.0	10.00	11.10	1	15.4	13.0	5.0
SMF10A	SMF10CA	10A	10CA	10.0	11.10	12.30	1	17.0	11.8	2.5
SMF11A	SMF11CA	11A	11CA	11.0	12.20	13.50	1	18.2	11.0	2.5
SMF12A	SMF12CA	12A	12CA	12.0	13.30	14.70	1	19.9	10.1	2.5
SMF13A	SMF13CA	13A	13CA	13.0	14.40	15.90	1	21.5	9.3	1
SMF14A	SMF14CA	14A	14CA	14.0	15.60	17.20	1	23.2	8.6	1
SMF15A	SMF15CA	15A	15CA	15.0	16.70	18.50	1	24.4	8.2	1
SMF16A	SMF16CA	16A	16CA	16.0	17.80	19.70	1	26.0	7.7	1
SMF17A	SMF17CA	17A	17CA	17.0	18.90	20.90	1	27.6	7.2	1
SMF18A	SMF18CA	18A	18CA	18.0	20.00	22.10	1	29.2	6.8	1
SMF20A	SMF20CA	20A	20CA	20.0	22.20	24.50	1	32.4	6.2	1
SMF22A	SMF22CA	22A	22CA	22.0	24.40	26.90	1	35.5	5.6	1
SMF24A	SMF24CA	24A	24CA	24.0	26.70	29.50	1	38.9	5.1	1
SMF26A	SMF26CA	26A	26CA	26.0	28.90	31.90	1	42.1	4.8	1
SMF28A	SMF28CA	28A	28CA	28.0	31.10	34.40	1	45.4	4.4	1
SMF30A	SMF30CA	30A	30CA	30.0	33.30	36.80	1	48.4	4.1	1
SMF33A	SMF33CA	33A	33CA	33.0	36.70	40.60	1	53.3	3.8	1
SMF36A	SMF36CA	36A	36CA	36.0	40.00	44.20	1	58.1	3.4	1
SMF40A	SMF40CA	40A	40CA	40.0	44.40	49.10	1	64.5	3.1	1
SMF43A	SMF43CA	43A	43CA	43.0	47.80	52.80	1	69.4	2.9	1
SMF45A	SMF45CA	45A	45CA	45.0	50.00	55.30	1	72.7	2.8	1
SMF48A	SMF48CA	48A	48CA	48.0	53.30	58.90	1	77.4	2.6	1
SMF51A	SMF51CA	51A	51CA	51.0	56.70	62.70	1	82.4	2.4	1
SMF54A	SMF54CA	54A	54CA	54.0	60.00	66.30	1	87.1	2.3	1
SMF58A	SMF58CA	58A	58CA	58.0	64.40	71.20	1	93.6	2.1	1
SMF60A	SMF60CA	60A	60CA	60.0	66.70	73.70	1	96.8	1.8	1
SMF64A	SMF64CA	64A	64CA	64.0	71.10	78.60	1	103.0	1.7	1
SMF70A	SMF70CA	70A	70CA	70.0	77.80	86.00	1	113.0	1.5	1
SMF75A	SMF75CA	75A	75CA	75.0	83.30	92.10	1	121.0	1.4	1

SMFxxxA(CA) Series

Type Number		Marking		Reverse Stand-Off Voltage	Breakdown Voltage Min. @ I_T	Breakdown Voltage Max. @ I_T	Test Current	Maximum Clamping Voltage@ I_{PP}	Maximum Peak Pulse Current	Reverse Leakage @ V_{RMW}
Uni	Bi	Uni	Bi	$V_{RMW}(V)$	$V_{BR MIN}(V)$	$V_{BR MAX}(V)$	$I_T (mA)$	$V_C(V)$	$I_{PP}(A)$	$I_R(\mu A)$
SMF78A	SMF78CA	78A	78CA	78.0	86.70	95.80	1	126.0	1.4	1
SMF85A	SMF85CA	85A	85CA	85.0	94.40	104.00	1	137.0	1.3	1
SMF90A	SMF90CA	90A	90CA	90.0	100.00	111.00	1	146.0	1.2	1
SMF100A	SMF100CA	100	100C	100.0	111.00	123.00	1	162.0	1.1	1
SMF110A	SMF110CA	110	110C	110.0	122.00	135.00	1	177.0	1.0	1
SMF120A	SMF120CA	120	120C	120.0	133.00	147.00	1	193.0	0.9	1
SMF130A	SMF130CA	130	130C	130.0	144.00	159.00	1	209.0	0.8	1
SMF150A	SMF150CA	150	150C	150.0	167.00	185.00	1	243.0	0.7	1
SMF160A	SMF160CA	160	160C	160.0	178.00	197.00	1	259.0	0.7	1
SMF170A	SMF170CA	170	170C	170.0	189.00	209.00	1	275.0	0.6	1
SMF180A	SMF180CA	180	180C	180.0	198.00	222.00	1	292.0	0.6	1
SMF190A	SMF190CA	190	190C	190.0	209.00	233.00	1	308.0	0.5	1

※ For Bi-directional type having V_{RMW} of 10 Volts and less, the I_R limit is double

I-V Curve Characteristics

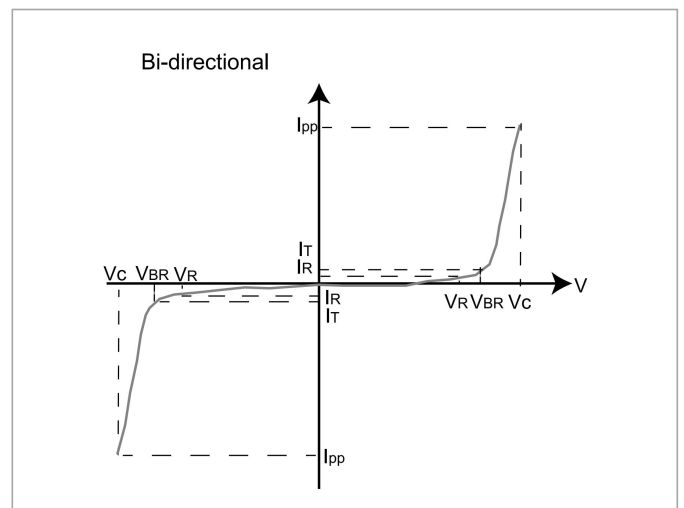
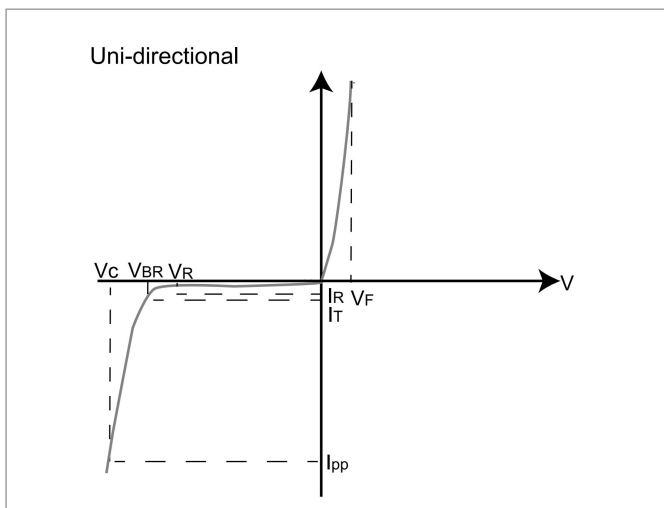

- P_{PPM} Peak Pulse Power Dissipation** ----- Max power dissipation
- V_R Stand-off Voltage** ----- Maximum voltage that can be applied to the TVS without operation
- V_{BR} Breakdown Voltage** ----- Maximum voltage that flows though the TVS at a specified test current (I_T)
- V_C Clamping Voltage** ----- Peak voltage measured across the TVS at a specified I_{PPM} (peak impulse current)
- I_R Reverse Leakage Current** -- Current measured at V_R
- V_F Forward Voltage Drop for Uni-directional**

SMFxxxA(CA) Series

Typical Performance Characteristics (TA=25°C unless otherwise Specified)

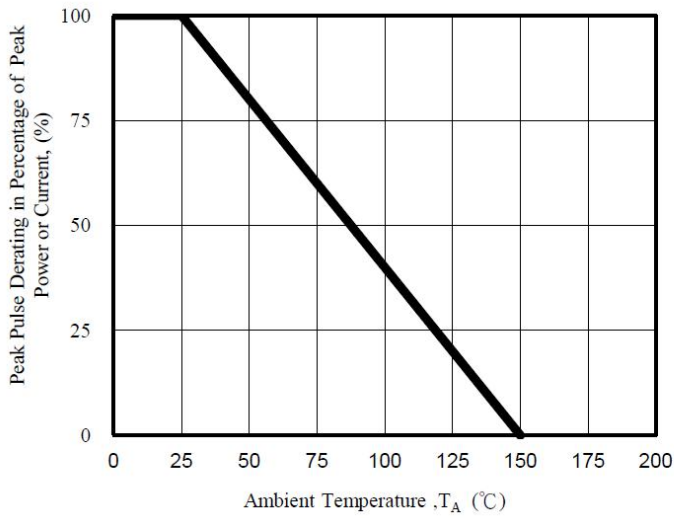

Fig. 1 - Pulse Derating Curve

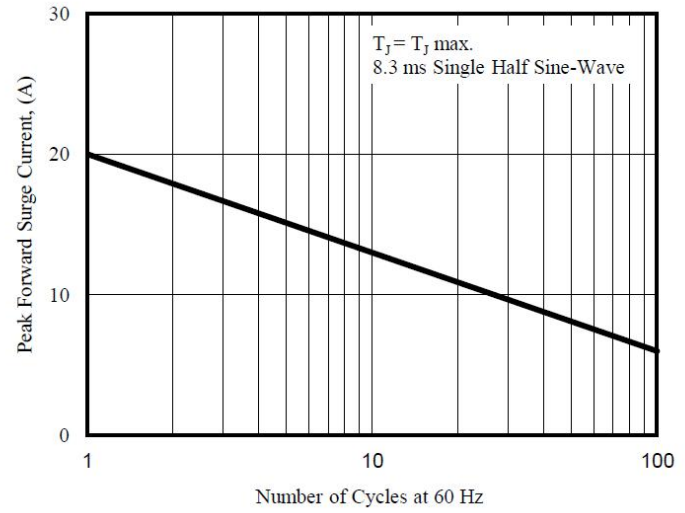

Fig. 2 - Maximum Non-Repetitive Surge Current

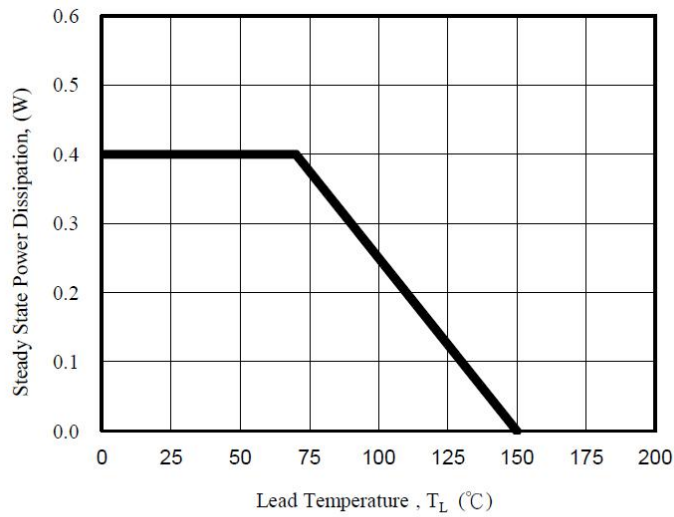

Fig. 3 - Steady State Power Derating Curve

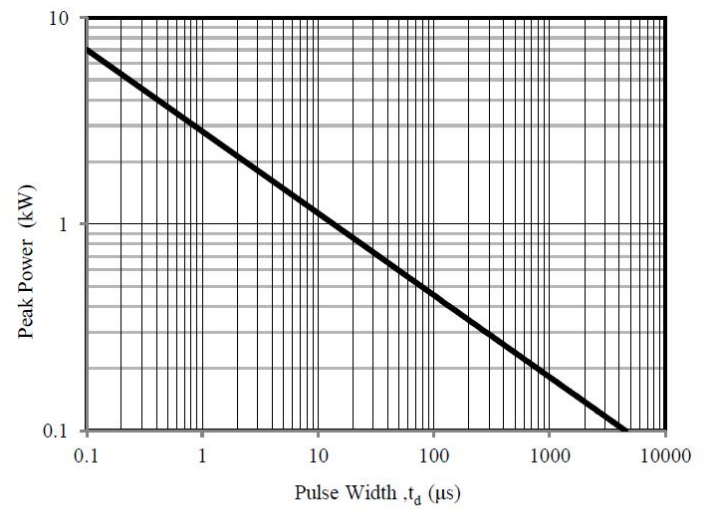

Fig. 4 - Peak Pulse Power Rating Curve

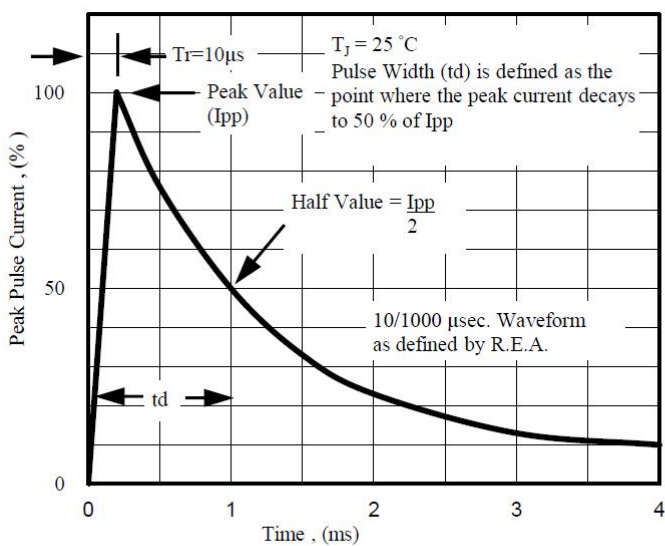

Fig. 5 - Pulse Waveform

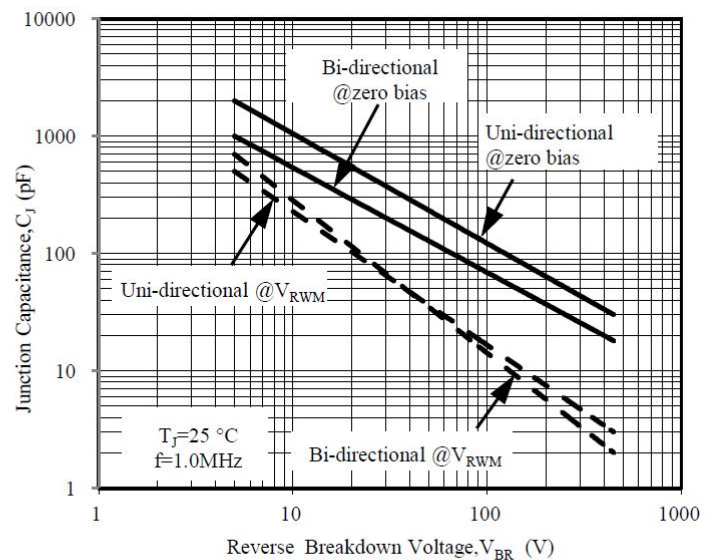
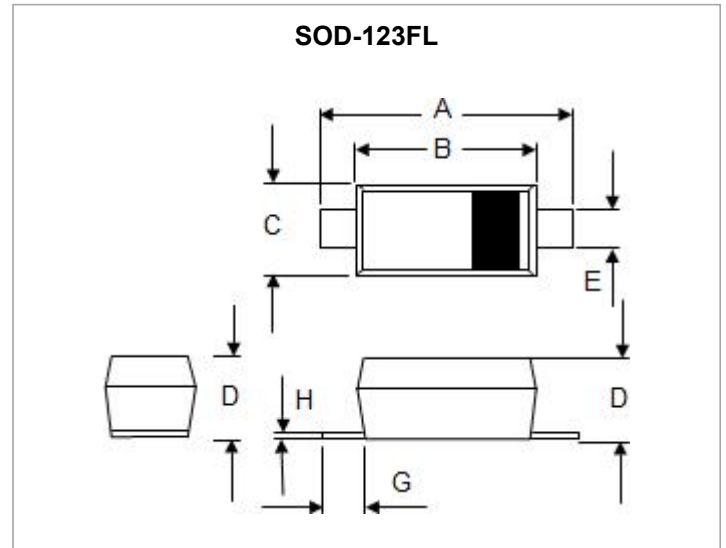

Fig. 6 - Typical Junction Capacitance

SMFxxxA(CA) Series

Package Outline Dimensions

Dim	Millimeters		Inches	
	Min	Max	Min	Max
A	3.40	3.95	0.142	0.155
B	2.50	2.90	0.098	0.114
C	1.40	1.95	0.055	0.077
D	0.90	1.35	0.035	0.053
E	0.50	1.10	0.020	0.043
G	0.25	-----	0.010	----
H	-----	0.20	----	0.008



Suggested PAD Layout

SIZE	SOD-123FL	
	(mm)	(inch)
A	3.47	0.137
B	0.78	0.031
C	1.22	0.048
D	4.25	0.167
E	2.70	0.106

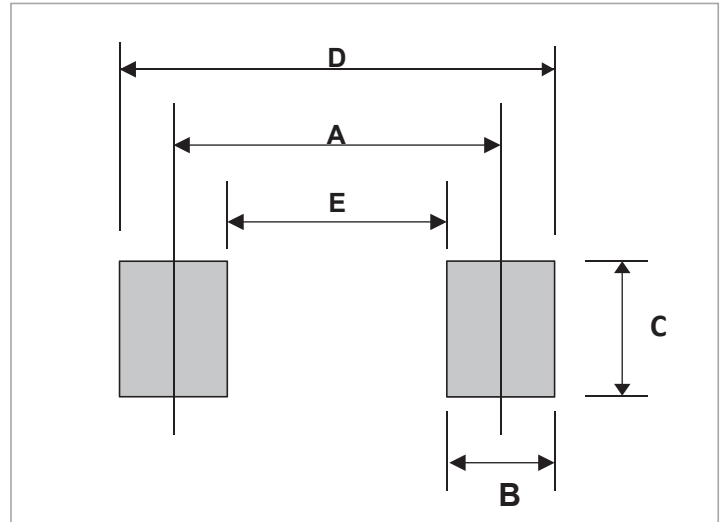

Ordering information

Part Number	Package	Weight	Base qty	Reel Size	Delivery mode
		grams(approx.)	(pcs)	(inch)	
SMFxxxA(CA)	SOD-123FL	0.014	3000	7	Tape and reel