

Description

The CLAMP0504DT is an ultra low capacitance TVS array, utilizing leading monolithic silicon technology to provide fast response time and low ESD clamping voltage, making this device an ideal solution for protecting voltage sensitive high-speed data lines. The CLAMP0504DT has an ultra-low capacitance with a typical value at 0.2pF, and complies with the IEC 61000-4-2 (ESD) standard with $\pm 25\text{kV}$ air and $\pm 20\text{kV}$ contact discharge. It is assembled into a 6-pin lead-free SOT23 package. The combination of small size, ultra low capacitance, and high ESD surge capability make it ideal for use in applications such as USB 3.0, multimedia, and other high speed ports.

Features

- Ultra low capacitance: 0.2.pF typical (I/O to I/O)
- Ultra low leakage: nA level
- Working voltage: 5V
- Low clamping voltage
- Up to 4 data lines and one power line protects
- Complies with following standards:
 - IEC 61000-4-2 (ESD) immunity test
Air discharge: $\pm 25\text{kV}$
Contact discharge: $\pm 20\text{kV}$
 - IEC61000-4-4 (EFT) 40A (5/50ns)
 - IEC61000-4-5 (Lightning) 4A (8/20 μs)
- RoHS Compliant

Dimensions & Symbol (Unit: mm Max)

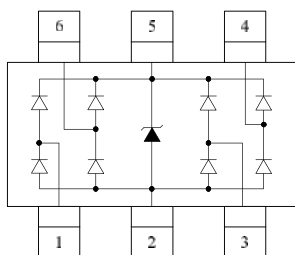

Circuit Diagram & Pin Schematic

Mechanical Characteristics

- Package: SOT23-6
- Lead Finish: Matte Tin
- Case Material: “Green” Molding Compound.
- UL Flammability Classification Rating 94V-0
- Moisture Sensitivity: Level 3 per J-STD-020
- Terminal Connections: See Diagram Below
- Marking Information: See Below

Applications

- USB 2.0 and USB 3.0 Ports
- USB OTG
- Digital Video Interface (DVI)
- Monitor and Flat Panel Displays
- PCI Express and Serial SATA Ports
- Gigabit Ethernet
- IEEE 1394 Firewire Ports
- Consumer products (STB, DVD, DSC, DVC...)

Marking information

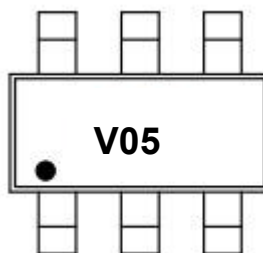

Dot denotes Pin1

Ordering Information

Part Number	Packaging	Reel Size
CLAMP0504DT	3000/Tape & Reel	7 inch

Absolute Maximum Ratings (T_A=25°C unless otherwise specified)

Parameter	Symbol	Value	Unit
Peak Pulse Power (8/20μs)	P _{pk}	60	W
Peak Pulse Current (8/20μs)	I _{pp}	4	A
ESD per IEC 61000-4-2 (Air)	V _{ESD}	±25	kV
ESD per IEC 61000-4-2 (Contact)		±20	
Operating Temperature Range	T _J	-55 to +125	°C
Storage Temperature Range	T _{stg}	-55 to +150	°C

Electrical Characteristics (T_A=25°C unless otherwise specified)

Parameter	Symbol	Min	Typ	Max	Unit	Test Condition
Reverse Working Voltage	V _{RWM}			5	V	
Breakdown Voltage	V _{BR}	6		9	V	I _T = 1mA
Reverse Leakage Current	I _R			1	μA	V _{RWM} = 5.0V
Clamping Voltage	V _C			10	V	I _{PP} = 1A (8 x 20μs pulse)
Clamping Voltage	V _C			15	V	I _{PP} = 4A (8 x 20μs pulse)
Junction Capacitance	C _J		0.45	0.5	pF	Between I/O pins and Ground V _R =0V, f=1MHZ
Junction Capacitance	C _J		0.2	0.3	pF	Between I/O pins V _R =0V, f=1MHZ
Junction Capacitance	C _J		0.8		pF	Between VCC and GND V _R =0V, f=1MHZ

Note: I/O Pins are pin 1,3,4,6. Pin 5 is Vcc. Pin 2 is GND.

Typical Performance Characteristics ($T_A=25^\circ\text{C}$ unless otherwise Specified)

Insertion Loss S21 of I/O to GND

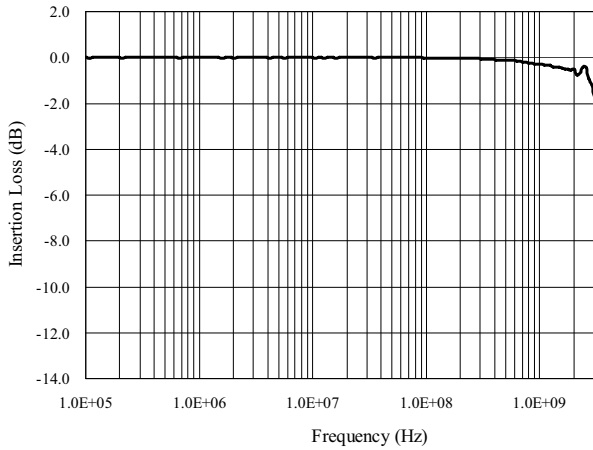

Normalized Capacitance vs. Reverse Voltage

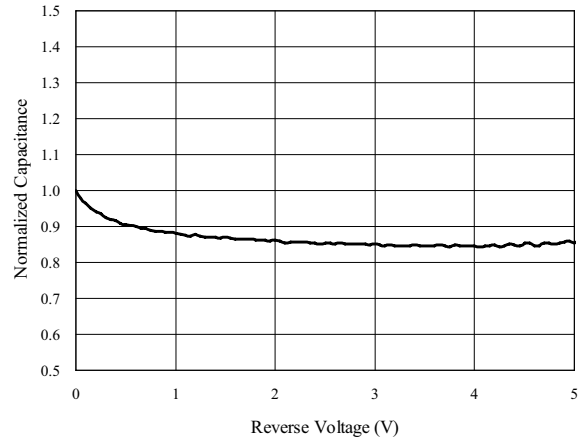

ESD Clamping
 (+8kV Contact per IEC 61000-4-2)

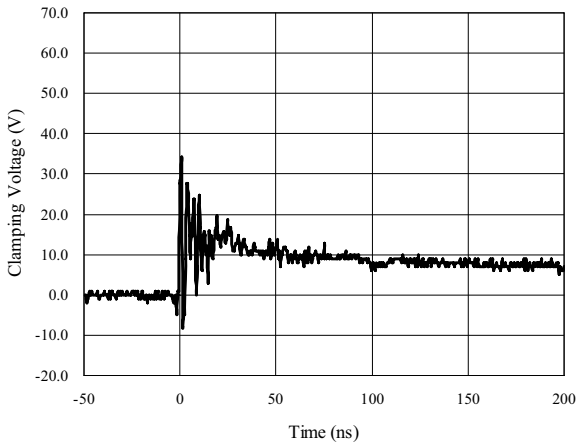

ESD Clamping
 (-8kV Contact per IEC 61000-4-2)

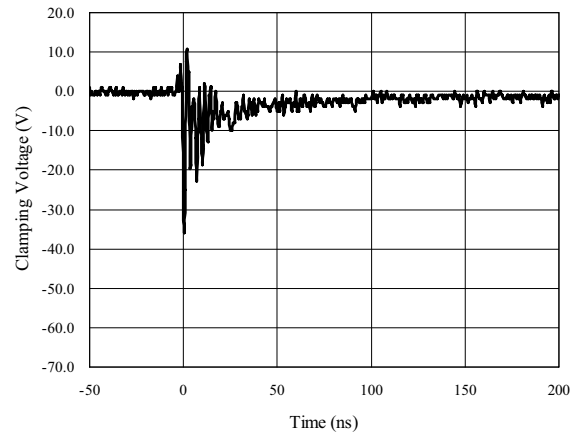

Soldering parameters

Reflow Condition		Pb-Free assembly (see FIG.2)
Pre Heat	-Temperature Min ($T_{s(min)}$)	+150°C
	-Temperature Max($T_{s(max)}$)	+200°C
	-Time (Min to Max) (t_s)	60-180 secs.
Average ramp up rate (Liquid us Temp (T_L) to peak)		3°C/sec. Max
$T_{s(max)}$ to T_L - Ramp-up Rate		3°C/sec. Max
Reflow	-Temperature(T_L) (Liquid us)	+217°C
	-Temperature(t_L)	60-150 secs.
Peak Temp (T_p)		+260(+0/-5)°C
Time within 5°C of actual Peak Temp (t_p)		30 secs. Max
Ramp-down Rate		6°C/sec. Max
Time 25°C to Peak Temp (T_p)		8 min. Max
Do not exceed		+260°C

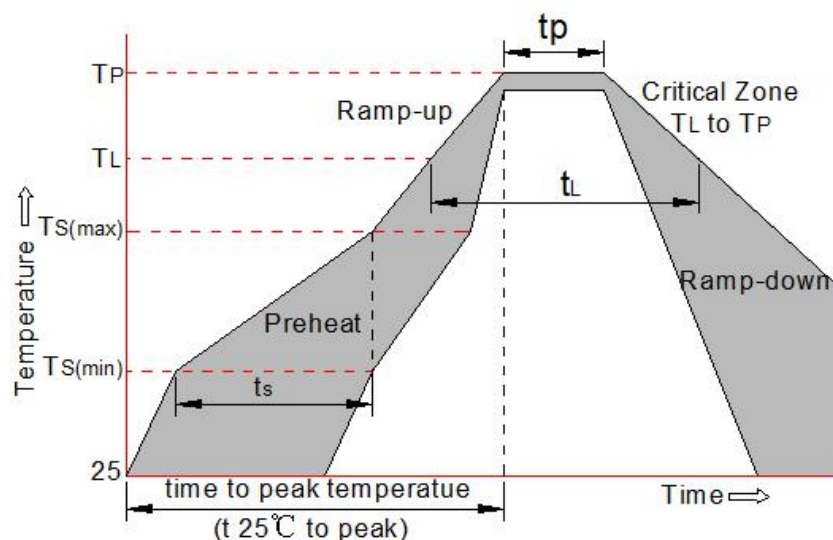

Package mechanical data

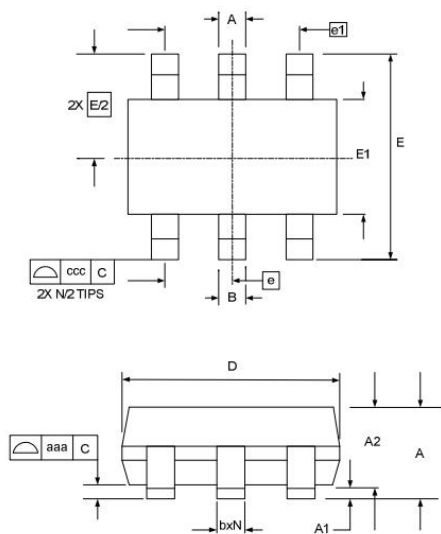

SYM	DIMENSIONS					
	MILLIMETERS			INCHES		
	MIN	NOM	MAX	MIN	NOM	MAX
A	0.90		1.45	0.035		0.057
A1	0.00		0.15	0.000		0.006
A2	0.90	1.15	1.30	0.035	0.045	0.051
b	0.25		0.50	0.010		0.020
c	0.08		0.22	0.003		0.009
D	2.80	2.90	3.10	0.110	0.114	0.122
E1	1.50	1.60	1.75	0.060	0.063	0.069
E	2.80 BSC			0.110 BSC		
e	0.95 BSC			0.037 BSC		
e1	1.90 BSC			0.075 BSC		
N	6			6		
aaa	0.10			0.004		
ccc	0.20			0.008		

Suggested Land Pattern

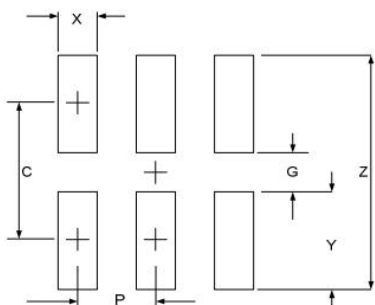

SYM	DIMENSIONS	
	MILLIMETERS	INCHES
C	2.50	0.098
G	1.40	0.055
P	0.95	0.037
X	0.60	0.024
Y	1.10	0.043
Z	3.60	0.141

Contact information

WPMTEK Incorporated Limited
 Room 206-207, 2nd Floor, Block 3, Minxing Industry Park, Minzhi
 Longhua New District, Shenzhen
 TEL: 86755-29308003 FAX: 86755-23739900

wpmtek Incorporated Limited (WPM) reserves the right to make changes to the product specification and data in this document without notice. WPM makes no warranty, representation or guarantee regarding the suitability of its products for any particular purpose, nor does WPM assume any liability arising from the application or use of any products or circuits, and specifically dis-claims any and all liability, including without limitation special, consequential or incidental damages.