

3mm Photodiode PD204-6B

Features

- Fast response time
- High photo sensitivity
- Small junction capacitance
- Pb free
- This product itself will remain within RoHS compliant version.
- Compliance with EU REACH



Description

PD204-6B is a high speed and high sensitive PIN photodiode in a standard 3Φ plastic package. The device is Spectrally matched to visible and infrared emitting diode.

Applications

- Automatic door sensor
- Copier
- Game machine

Device Selection Guide

Chip Materials	Lens Color
Silicon	Black

Absolute Maximum Ratings (Ta=25°C)

Parameter	Symbol	Rating	Unit
Reverse Voltage	V_R	32	V
Operating Temperature	T_{opr}	-40 ~ +85	°C
Storage Temperature	T_{stg}	-40 ~ +100	°C
Soldering Temperature	T_{sol}	260	°C
Power Dissipation at (or below) 25°C Free Air Temperature	P_c	150	mW

Electro-Optical Characteristics (Ta=25°C)

Parameter	Symbol	Min.	Typ.	Max.	Unit	Condition
Range Of Spectral Bandwidth	$\lambda_{0.5}$	840	-----	1100	nm	-----
Wavelength Of Peak Sensitivity	λ_P	-----	940	-----	nm	-----
Open-Circuit Voltage	V_{OC}	-----	0.42	-----	V	$E_e=1mW/cm^2$ $\lambda_p=940nm$
Short- Circuit Current	I_{SC}	-----	3.0	-----	μA	$E_e=1mW/cm^2$ $\lambda_p=940nm$
Reverse Light Current	I_L	1.0	3.0	----	μA	$E_e=1mW/cm^2$ $\lambda_p=940nm$ $V_R=5V$
Reverse Dark Current	I_D	----	----	10	nA	$E_e=0mW/cm^2$ $V_R=10V$
Reverse Breakdown Voltage	V_{BR}	32	170	----	μA	$E_e=0mW/cm^2$ $I_R=100\mu A$
Total Capacitance	C_t	-----	5	-----	pF	$E_e=0mW/cm^2$ $V_R=5V$ $f=1MHz$
Rise Time/ Fall Time	t_r / t_f	-----	6	-----	ns	$V_R=10V$ $R_L=100\Omega$

Note:

Tolerance of Luminous Intensity: $\pm 10\%$
Tolerance of Dominant Wavelength: $\pm 1nm$
Tolerance of Forward Voltage: $\pm 0.1V$

Typical Electro-Optical Characteristics Curves

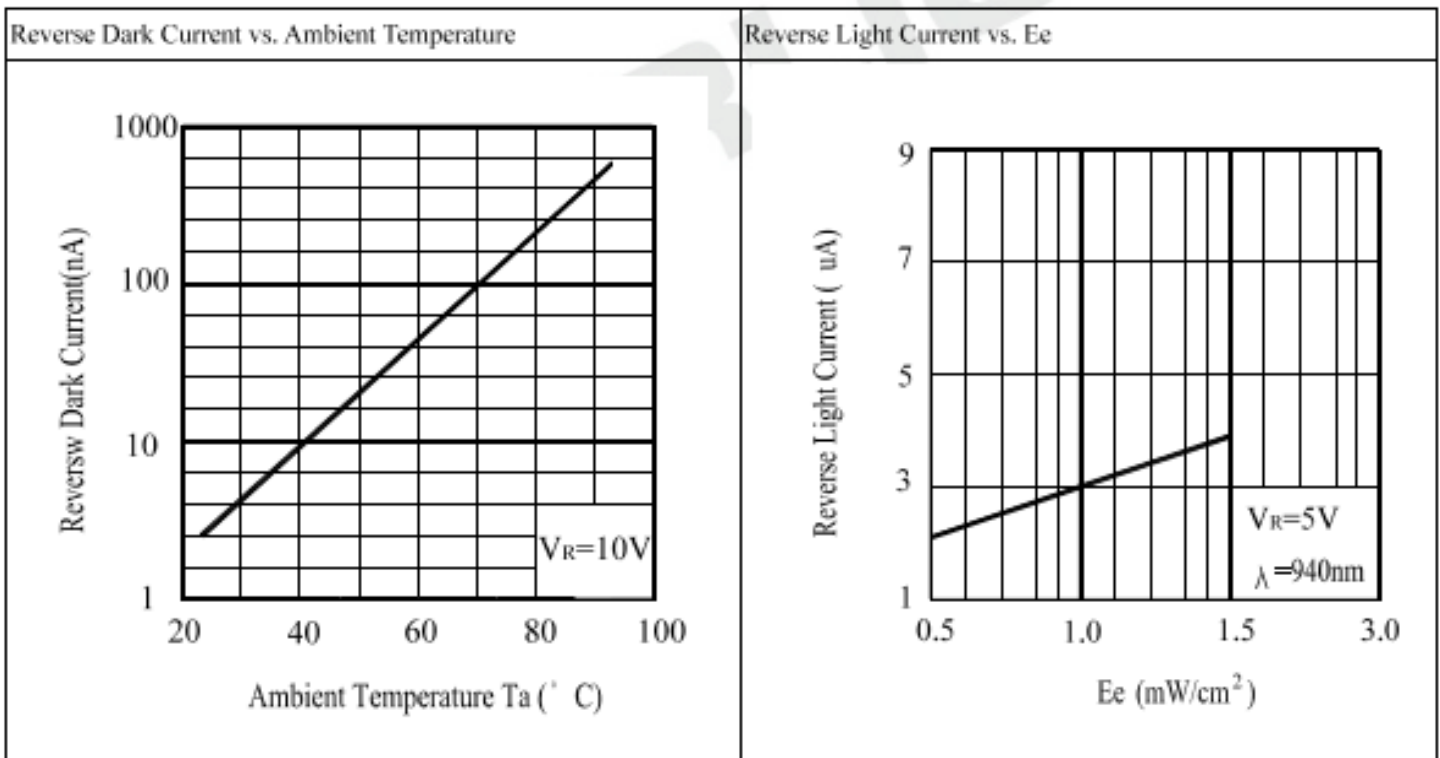
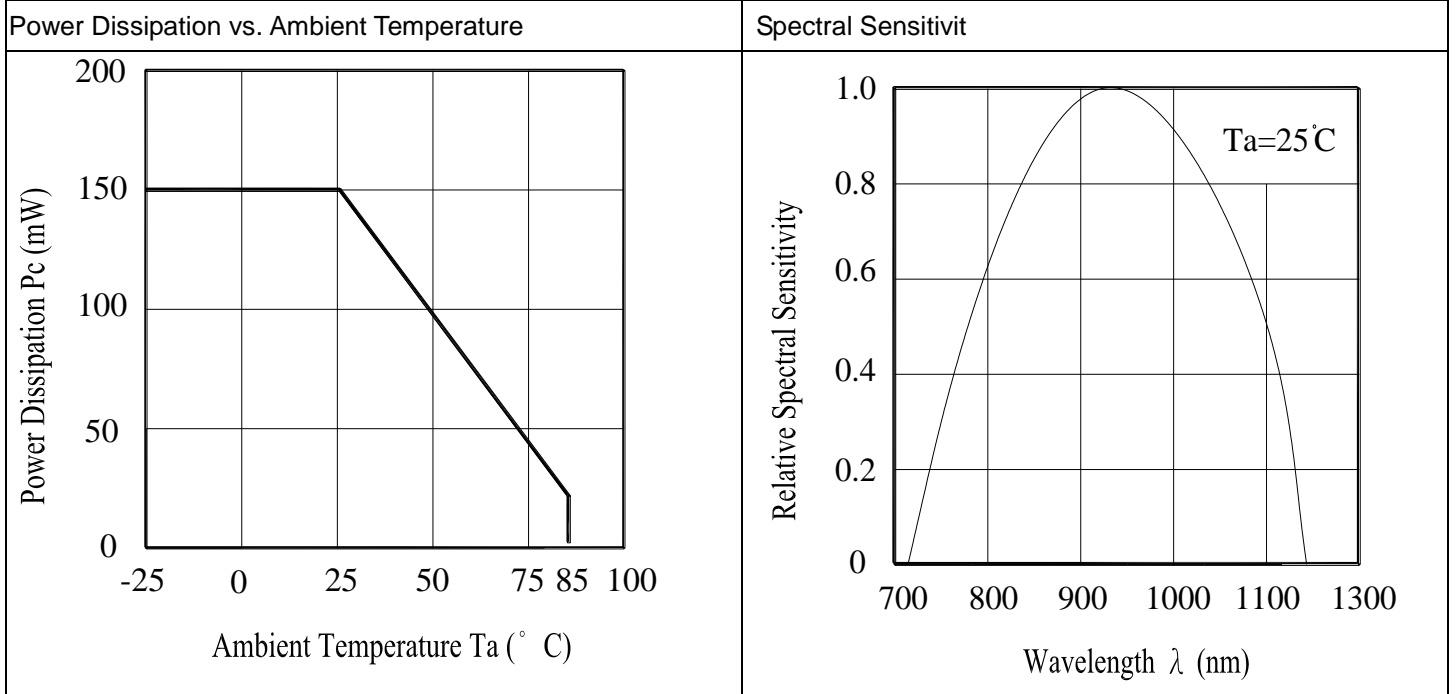

Terminal Capacitance vs. Reverse Voltage

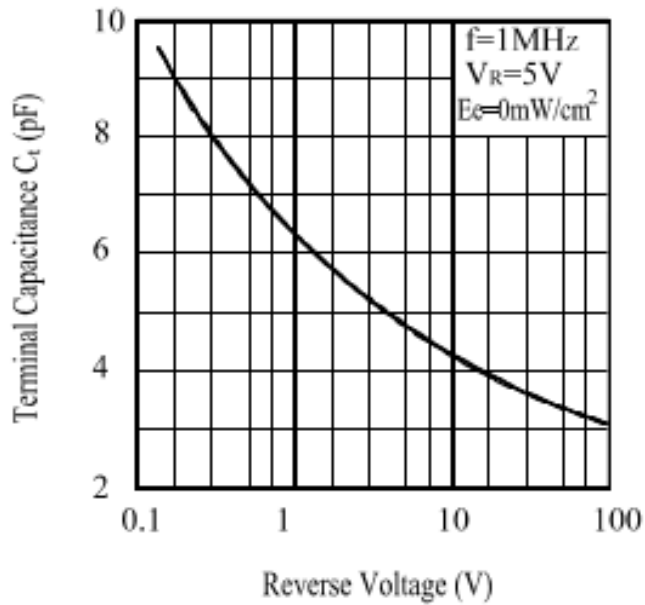

Response Time vs. Load Resistance

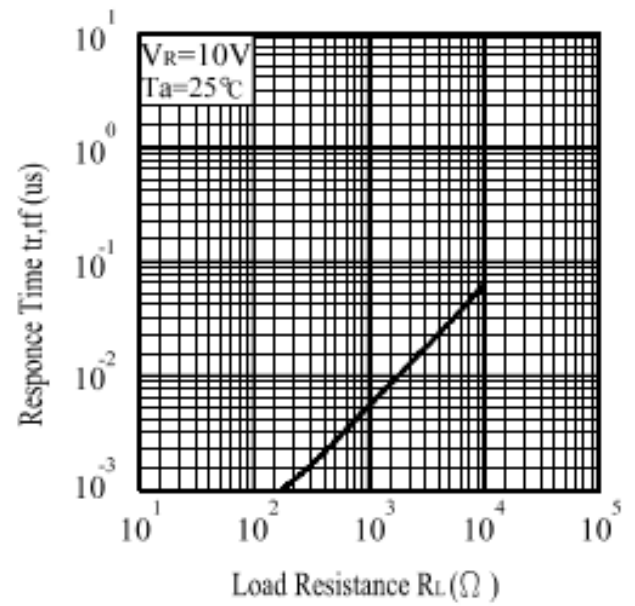

Package Dimension

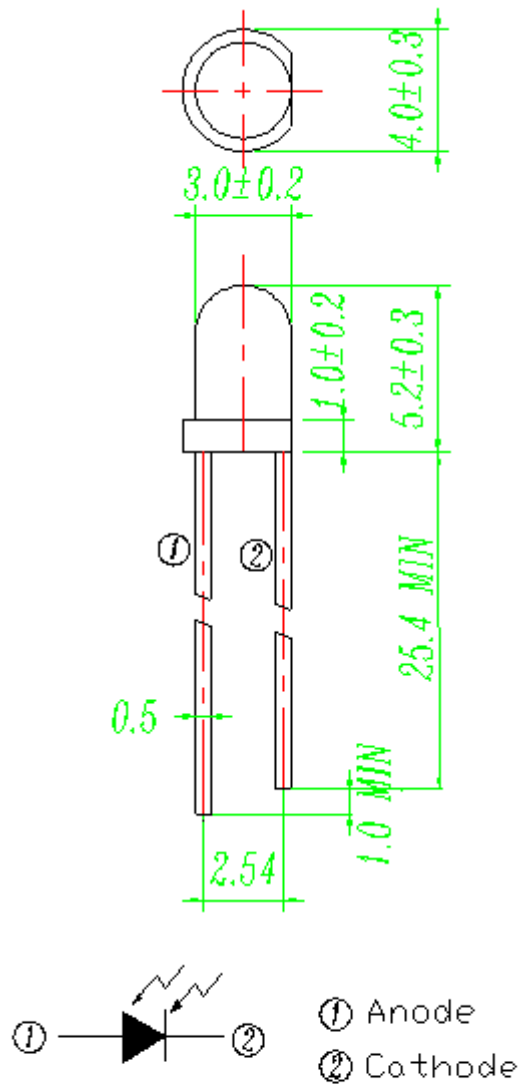

Note: Tolerances unless dimensions ± 0.25 mm

Packing Quantity Specification

■ Anti-electrostatic bag



■ Inner Carton

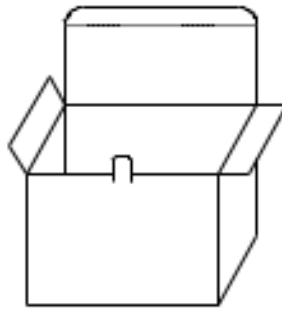

■ Outside Carton

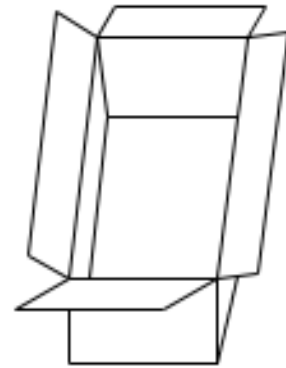

1. 200~1000PCS/1Bag,4Bags/1 Inner Carton
2. 1 Inner Cartons /1 Outside Carton

Label Form Specification

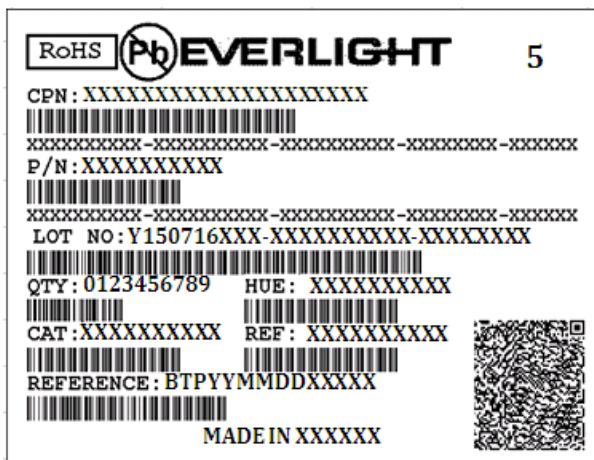

- CPN: Customer's Product Number
- P/N: Product Number
- QTY: Packing Quantity
- CAT: Luminous Intensity Rank
- HUE: Dom. Wavelength Rank
- REF: Forward Voltage Rank
- LOT No: Lot Number
- X: Month
- Reference: Identify Label Number

DISCLAIMER

1. EVERLIGHT reserves the right(s) on the adjustment of product material mix for the specification.
2. The product meets EVERLIGHT published specification for a period of twelve (12) months from date of shipment.
3. The graphs shown in this datasheet are representing typical data only and do not show guaranteed values.
4. When using this product, please observe the absolute maximum ratings and the instructions for using outlined in these specification sheets. EVERLIGHT assumes no responsibility for any damage resulting from the use of the product which does not comply with the absolute maximum ratings and the instructions included in these specification sheets.
5. These specification sheets include materials protected under copyright of EVERLIGHT. Reproduction in any form is prohibited without obtaining EVERLIGHT's prior consent.
6. This product is not intended to be used for military, aircraft, automotive, medical, life sustaining or life saving applications or any other application which can result in human injury or death. Please contact authorized Everlight sales agent for special application request.