

SOT-23 Plastic-Encapsulate MOSFETS

TF2323

TF2323 P-Channel 15-V(D-S) MOSFET

$V_{(BR)DSS}$	$R_{DS(on)MAX}$	I_D
-15V	0.035Ω@-4.5V	-4.7A
	0.048Ω@-2.5V	
	0.060Ω@-1.8V	

General FEATURE

- TrenchFET Power MOSFET
- Lead free product is acquired
- Surface mount package

APPLICATION

- Load Switch for Portable Devices
- DC/DC Converter

SOT-23

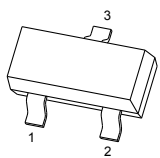

1.GATE
2.SOURCE
3.DRAIN

MARKING

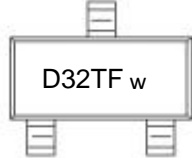

*w: week code

Equivalent Circuit

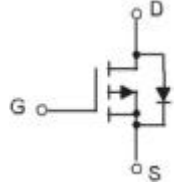

Maximum ratings ($T_a=25^{\circ}\text{C}$ unless otherwise noted)

Parameter	Symbol	Value	Unit
Drain-Source Voltage	V_{DS}	-15	V
Gate-Source Voltage	V_{GS}	±10	
Continuous Drain Current	I_D	-4.7	A
Pulsed Drain Current	I_{DM}	-20	
Continuous Source-Drain Diode Current	I_S	-1.4	
Maximum Power Dissipation	P_D	1	W
Thermal Resistance from Junction to Ambient($t \leq 5s$)	$R_{\theta JA}$	74	$^{\circ}\text{C/W}$
Junction Temperature	T_J	150	$^{\circ}\text{C}$
Storage Temperature	T_{stg}	-55 ~+150	



SOT-23 Plastic-Encapsulate MOSFETS

TF2323

MOSFET ELECTRICAL CHARACTERISTICS

T_a =25 °C unless otherwise specified

Parameter	Symbol	Test Condition	Min	Typ	Max	Units
Static						
Drain-source breakdown voltage	V _{(BR)DSS}	V _{GS} = 0V, I _D = -250μA	-15			V
Gate-source threshold voltage	V _{GS(th)}	V _{DS} = V _{GS} , I _D = -250μA	-0.4	-0.7	-1	
Gate-source leakage	I _{GSS}	V _{DS} = 0V, V _{GS} = ±8V			±100	nA
Zero gate voltage drain current	I _{DSS}	V _{DS} = -12V, V _{GS} = 0V			-100	nA
Drain-source on-state resistance ^a	R _{Ds(on)}	V _{GS} = -4.5V, I _D = -4.7A		0.033	0.035	Ω
		V _{GS} = -2.5V, I _D = -4.1A		0.045	0.048	
		V _{GS} = -1.8V, I _D = -2.0A		0.055	0.060	
Forward transconductance ^a	g _{fs}	V _{DS} = -5V, I _D = -2.0A		5.0	-	S
Dynamic^b						
Input capacitance	C _{iSS}	V _{DS} = -4V, V _{GS} = 0V, F = 1.0MHz		740		pF
Output capacitance	C _{oSS}			290		
Reverse transfer capacitance	C _{rSS}			190		
Total gate charge	Q _g	V _{DS} = -4V, I _D = -4.7A, V _{GS} = -4.5V		7.8		nC
Gate-source charge	Q _{gs}			1.2		
Gate-drain charge	Q _{gd}			1.6		
Gate resistance	R _g	f = 1MHz	1.9		19	Ω
Turn-on delay time	t _{d(on)}	V _{DD} = -4V, I _D = -3.3A , R _L = -1.2Ω, V _{GEN} = -4.5V, R _g = 1Ω		12.0		ns
Rise time	t _r			35.0		
Turn-off delay time	t _{d(off)}			30.0		
Fall time	t _f			10.0		
Drain-source body diode characteristics						
Continuous source-drain diode current	I _s	T _C = 25°C			-1.6	A
Body diode voltage	V _{SD}	I _s = -1.6A		-0.8	-1.2	V

Notes :

a. Pulse Test : Pulse Width < 300μs, Duty Cycle ≤2%.

b. Guaranteed by design, not subject to production testing.

Typical Electrical and Thermal Characteristics

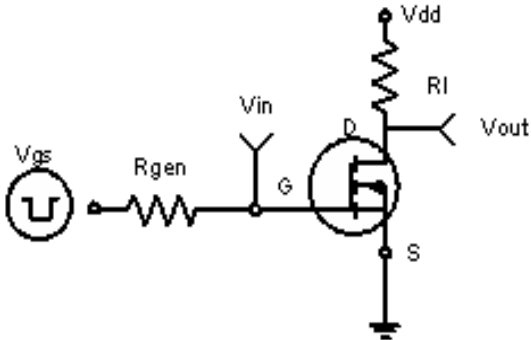

Figure 1: Switching Test Circuit

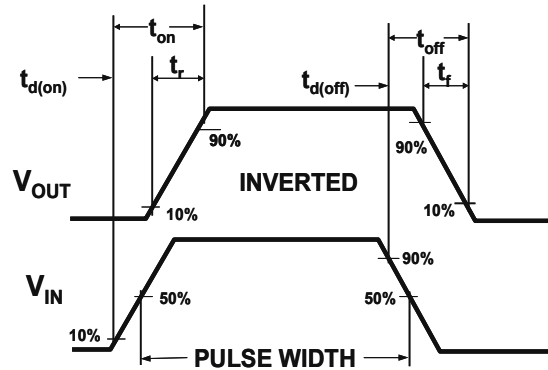

Figure 2: Switching Waveforms

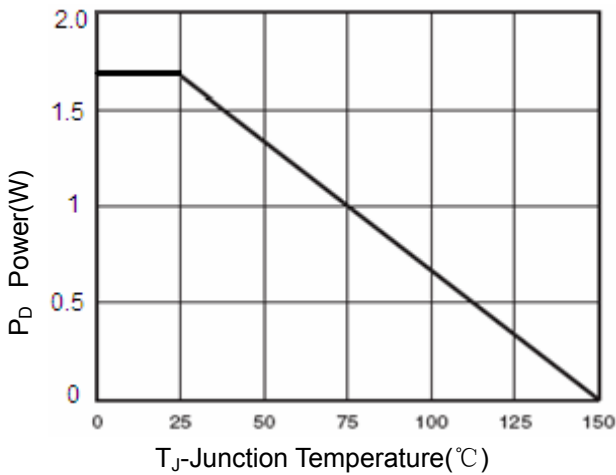

Figure 3 Power Dissipation

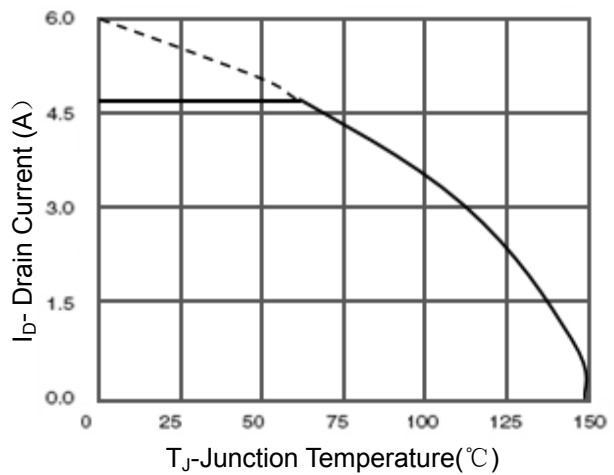

Figure 4 Drain Current

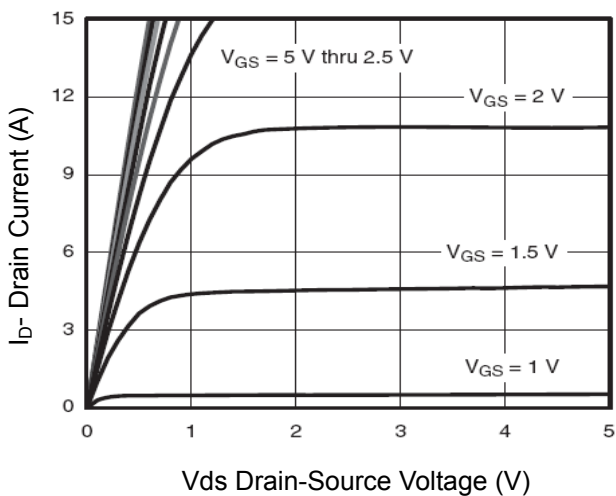

Figure 5 Output Characteristics

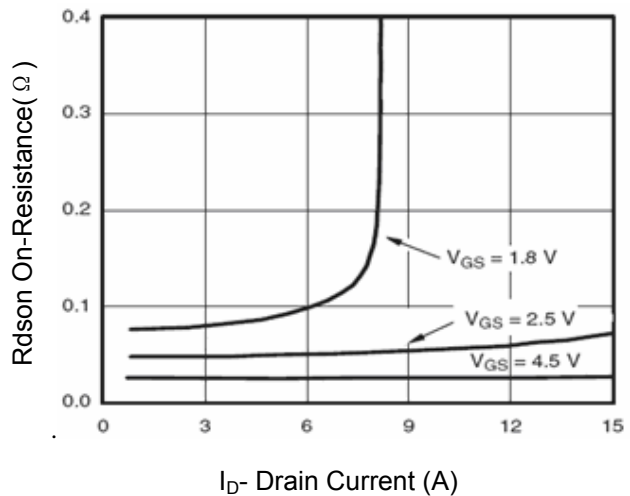

Figure 6 Drain-Source On-Resistance

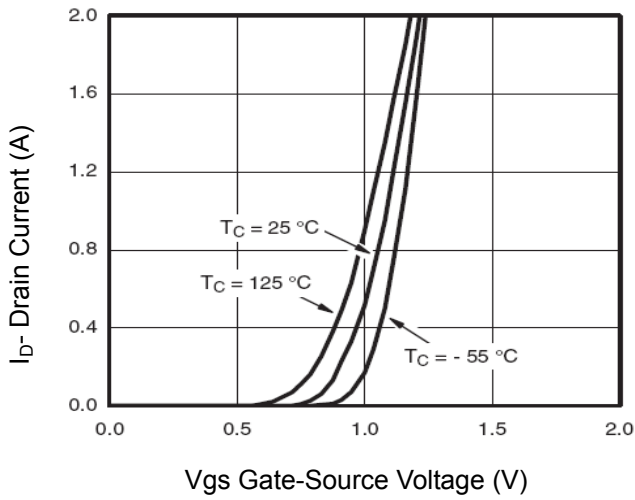

Figure 7 Transfer Characteristics

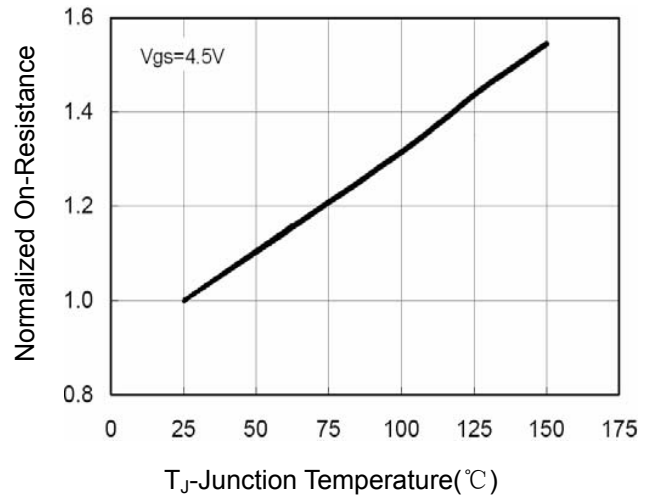

Figure 8 Drain-Source On-Resistance

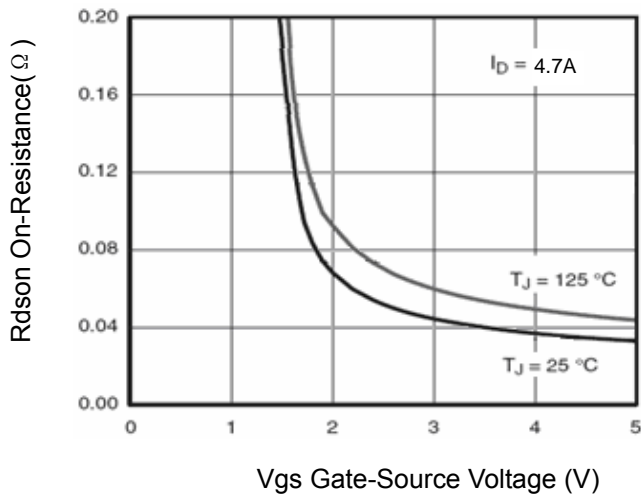

Figure 9 Rdson vs Vgs

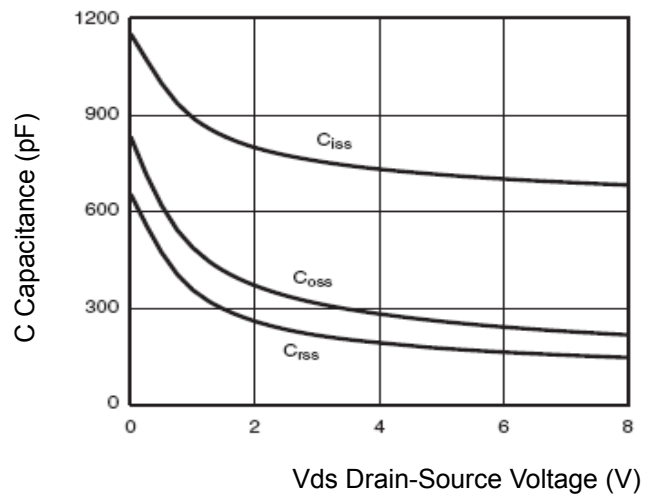

Figure 10 Capacitance vs Vds

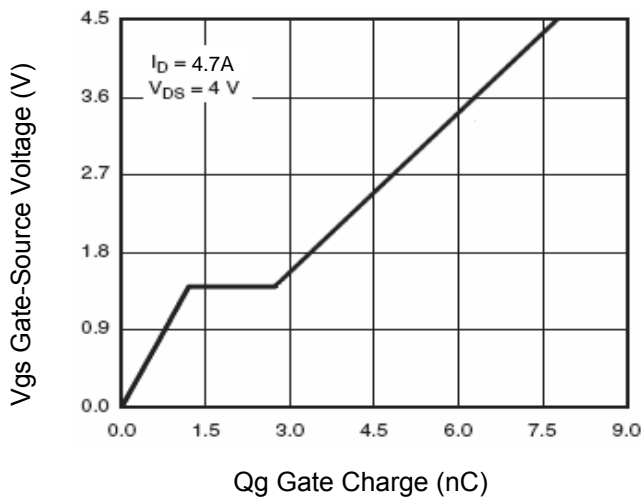

Figure 11 Gate Charge

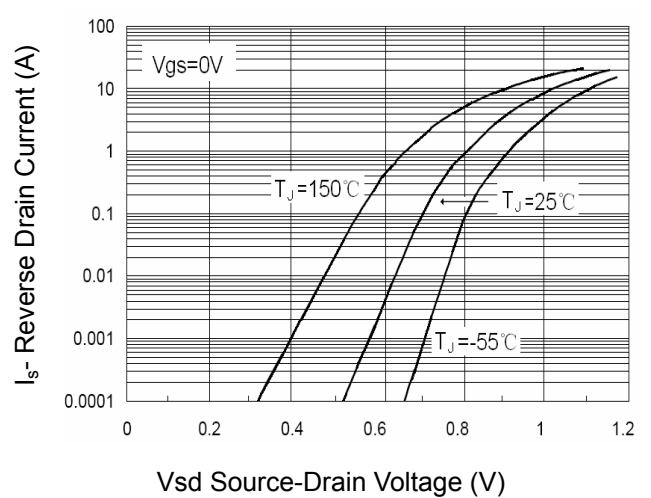

Figure 12 Source- Drain Diode Forward

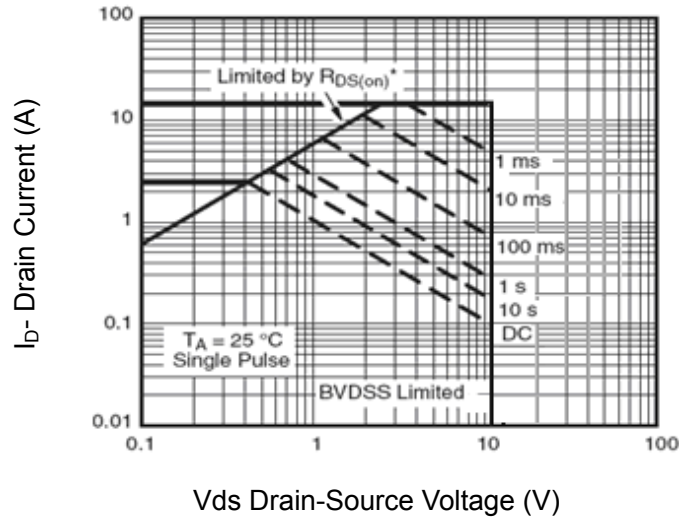

Figure 13 Safe Operation Area

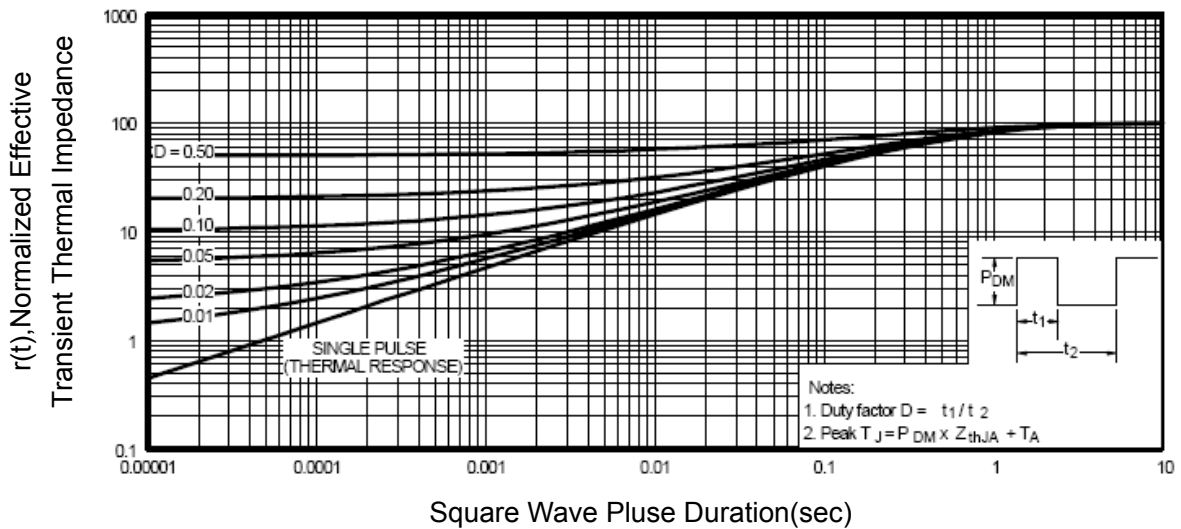
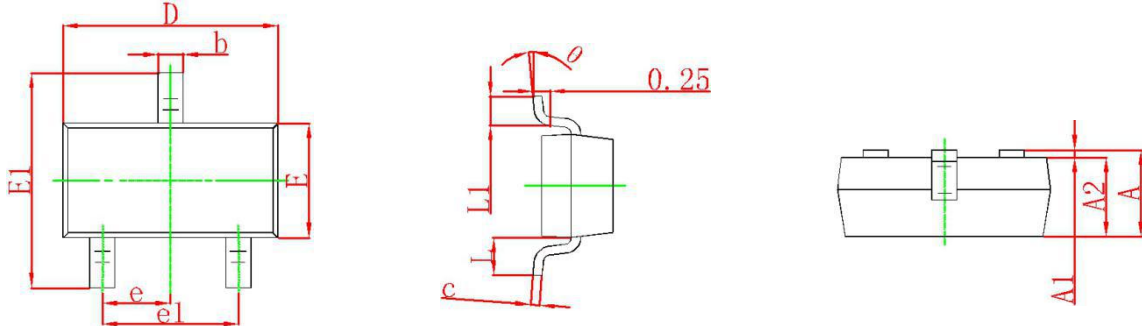

Figure 14 Normalized Maximum Transient Thermal Impedance

SOT-23 Package Outline Dimensions



Symbol	Dimensions In Millimeters		Dimensions In Inches	
	Min	Max	Min	Max
A	0.900	1.150	0.035	0.045
A1	0.000	0.100	0.000	0.004
A2	0.900	1.050	0.035	0.041
b	0.300	0.500	0.012	0.020
c	0.080	0.150	0.003	0.006
D	2.800	3.000	0.110	0.118
E	1.200	1.400	0.047	0.055
E1	2.250	2.550	0.089	0.100
e	0.950 TYP		0.037 TYP	
e1	1.800	2.000	0.071	0.079
L	0.550 REF		0.022 REF	
L1	0.300	0.500	0.012	0.020
θ	0°	8°	0°	8°

SOT-23 Suggested Pad Layout

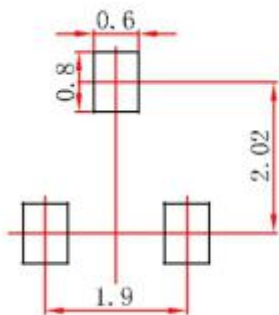

Note:
 1. Controlling dimension: in millimeters.
 2. General tolerance: $\pm 0.05\text{mm}$.
 3. The pad layout is for reference purposes only.