

# SK6019 -- Low Noise, High PSRR, High Speed, CMOS LDO

## GENERAL DESCRIPTION

The SK6019 is a high accuracy, low noise, high speed, low dropout CMOS Linear regulator with high ripple rejection and fast discharge function. The device offers a new level of cost effective performance in cellular phones, surveillance system, Bluetooth, wireless and other portable electronic devices.

SK6019 can provide product selections of output value in the range of 1.0V~3.6V by every 0.1V step.

SK6019 offer over temperature protection to ensure the device working in well conditions.

The SK6019 regulators are available in standard DFN1x1-4L packages. Standard products are Pb-free and Halogen-free.

## FEATURES

- Input voltage: 2.5V~6.5V
- Output range: 1.0V~3.6V  
(customized by every 0.1V step)
- Maximum output current: 750mA @  $V_{IN}-V_{OUT}=0.5V$
- PSRR: 75dB @1KHz 55dB@1MHz
- Dropout voltage: 110mV @  $I_{OUT}=200mA$
- Quiescent current : 45 $\mu$ A Typ.
- Shut-down current: < 1 $\mu$ A
- Recommend capacitor: 1 $\mu$ F
- Ultra-low output noise: 20 $\mu$ V<sub>RMS</sub>

## APPLICATIONS

- Digital cameras
- Cellphones
- Bluetooth and wireless handsets
- Other portable electronic device

## TYPICAL APPLICATION CIRCUIT

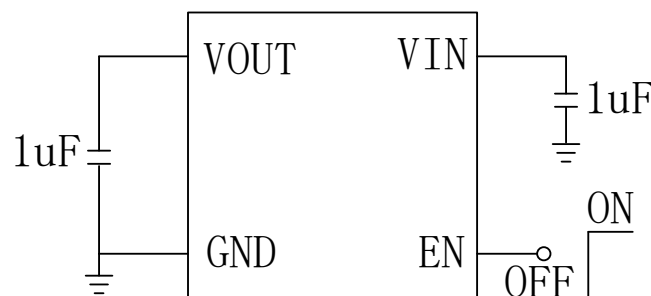

## PIN ASSIGNMENT



DFN1x1-4L

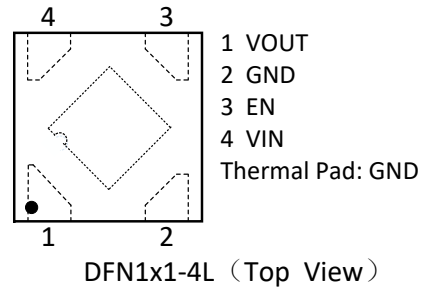

## ORDER INFORMATION

PART NO	PACAKGE	VOUT DISCHARGE	TEMPERATURE	TAPE & REEL
SK6019AD4-XX <sup>Note</sup>	DFN1x1-4L	Yes	-40 ~ +85°C	10000/REEL

**Note:** XX indicates 1.0V~3.6V by 0.1V step. For example, 28 means product outputs 2.8V

## PART NUMBER RULES

SK6019 **1** - **2** - **3**

Code	Description
<b>1</b>	Vout discharge A: Yes
<b>2</b>	Package: D4: DFN1x1-4L
<b>3</b>	Voltage version: XX: 1.0V~3.6V by 0.1V step Example: 28: 2.8V

## MARKING DESCRIPTION:

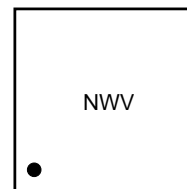

DFN1x1-4L

“N”: Product code, here use “N” stands for “SK6019”.

“W”: The week of manufacturing. “A” stands for week 1, “Z” stands for week 26, “a” stands for week 27, “z” stands for week 52.

“V”: Output voltage code.

## PIN DESCRIPTION

PIN NO	SYMBOL	I/O	DESCRIPTION
1	VOUT	O	Output
2	GND	Ground	Ground
3	EN	I	Enable (active high, do not float)
4	VIN	Power	Input

## TYPICAL OUTPUT VOLTAGE CODE TABLE

V <sub>OUT</sub>	CODE	V <sub>OUT</sub>	CODE
1.0V	A	1.2V	B
1.5V	C	1.8V	D
2.8V	M	3.0V	G
3.3V	H	3.6V	I

## ABSOLUTE MAXIMUM RATINGS (Note)

SYMBOL	ITEMS	VALUE	UNIT
V <sub>IN</sub>	Input Voltage	-0.3~8	V
I <sub>OUT</sub>	Output Current	750	mA
P <sub>DMAX</sub>	Power Dissipation	DFN1x1-4L	0.3
T <sub>J</sub>	Junction Temperature	-40~125	°C
T <sub>A</sub>	Ambient Temperature	-40~85	°C
T <sub>STG</sub>	Storage Temperature	-55 to 150	°C
T <sub>SOLDER</sub>	Package Lead Soldering Temperature	260°C, 10s	

**Note:** Exceed these limits to damage to the device. Exposure to absolute maximum rating conditions may affect device reliability.

## RECOMMENDED OPERATING RANGE

SYMBOL	ITEMS	VALUE	UNIT
V <sub>IN</sub>	Supply Voltage	2.5 to 6.5	V
I <sub>OUT</sub>	Output Current	<500	mA
T <sub>OPT</sub>	Operating Temperature	-40 to +85	°C

## SIMPLIFIED BLOCK DIAGRAM

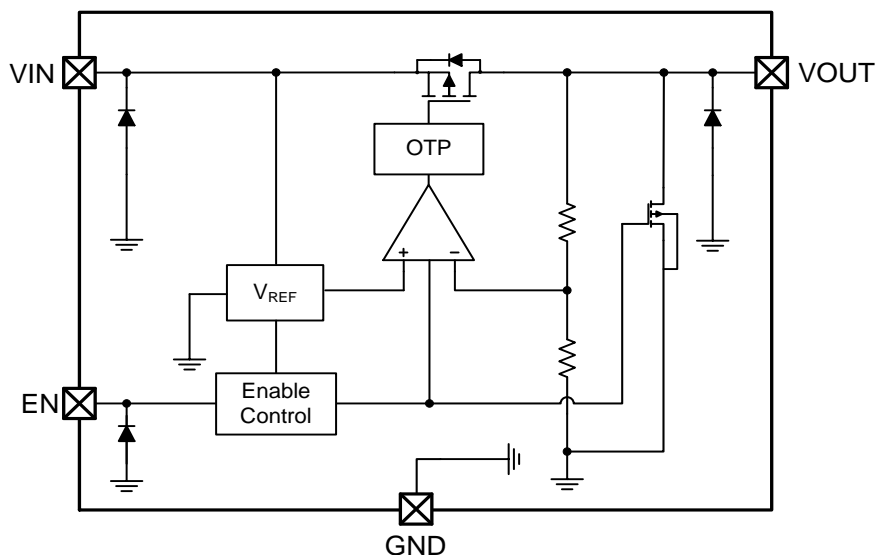

## ELECTRICAL CHARACTERISTICS

The following specifications apply for  $V_{IN}=4.3V$ ,  $V_{OUT}=3.3V$ ,  $T_A=25^{\circ}C$ , unless specified otherwise.

SYMBOL	ITEMS	CONDITIONS	MIN	TYP	MAX	UNIT
$V_{IN}$	Input Voltage				6.5	V
$V_{OUT}$	Output Range	$V_{OUT} < 2V$ , $V_{IN}=2.7V$ , $I_{OUT}=1mA$	-3	$V_{OUT}$	3	%
		$V_{OUT} \geq 2V$ , $I_{OUT}=1mA$	-2	$V_{OUT}$	2	
$I_Q$	Quiescent Current	$V_{OUT}=3.3V$ , $I_{OUT}=0$		45		$\mu A$
$I_{OUT\_PK}$	Maximum Output Current	$V_{IN}=V_{EN}=4.3V$		700		mA
$V_{DROP}$	Dropout Voltage	$V_{OUT}=3.3V$ , $I_{OUT}=200mA$		110	125	mV
		$V_{OUT}=3.3V$ , $I_{OUT}=300mA$		160	175	
$\Delta V_{LINE}$	Line Regulation	$V_{IN}=3.5\sim 5.5V$ , $I_{OUT}=1mA$		0.01	0.15	%/V
$\Delta V_{LOAD}$	Load Regulation	$V_{OUT}=3.3V$ , $I_{OUT}=1\sim 300mA$		40	70	mV
$I_{SHDN}$	Shut-down Current	$V_{EN}=0V$			1	$\mu A$
PSRR	Power Supply Rejection Rate	$V_{IN}=5V_{DC}+0.5V_{P-P}$ $F=1KHz$ , $I_{OUT}=10mA$		75		dB
		$V_{IN}=5V_{DC}+0.5V_{P-P}$ $F=1MHz$ , $I_{OUT}=10mA$		55		
$V_{ENH}$	EN logic high voltage	$V_{IN}=5.5V$ , $I_{OUT}=1mA$	1.2		$V_{IN}$	V
$V_{ENL}$	EN logic low voltage	$V_{IN}=5.5V$ , $V_{OUT}=0V$			0.4	V
$I_{EN}$	EN Input Current	$V_{EN}=0$ to 5.5V			1.0	$\mu A$
$e_{NO}$	Output Noise Voltage	10Hz to 100KHz, $C_{OUT}=1\mu F$		20		$\mu V_{RMS}$
$T_{SD}$	Thermal Shutdown Protection	$V_{IN}=V_{EN}=4.3V$ , $I_{OUT}=1mA$		160		$^{\circ}C$

## TYPICAL PERFORMANCE CHARACTERISTICS

$C_{IN}=1\mu F$ ,  $C_{OUT}=1\mu F$ ,  $V_{IN}=4.3V$ ,  $V_{OUT}=3.3V$   $T_A=25^\circ C$ , unless specified otherwise.

IQ vs. Input Voltage

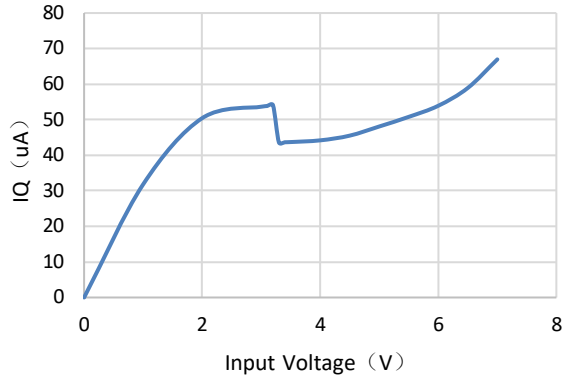

IQ vs. Temperature

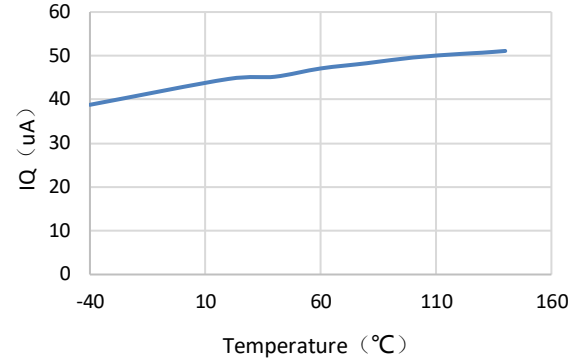

Output Voltage vs. Input Voltage

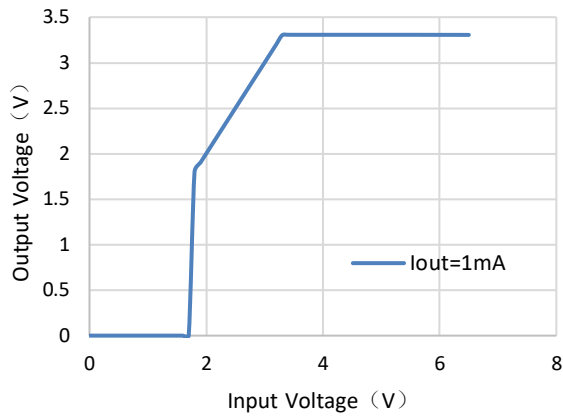

Output Voltage vs. Temperature

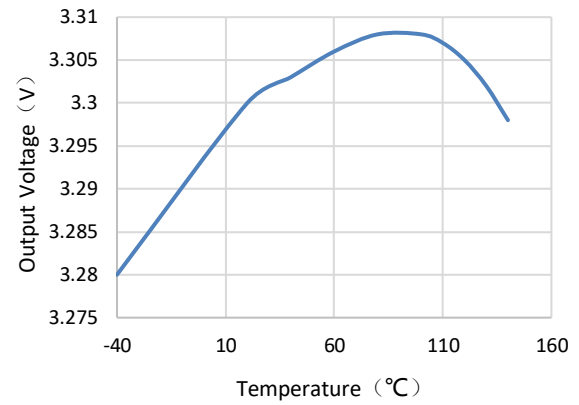

output voltage vs. output current

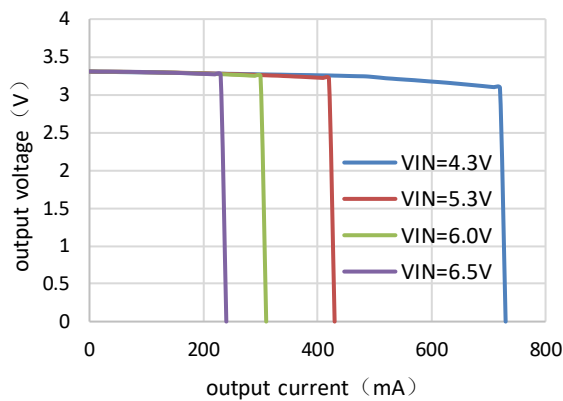

Dropout Voltage vs. Output Current

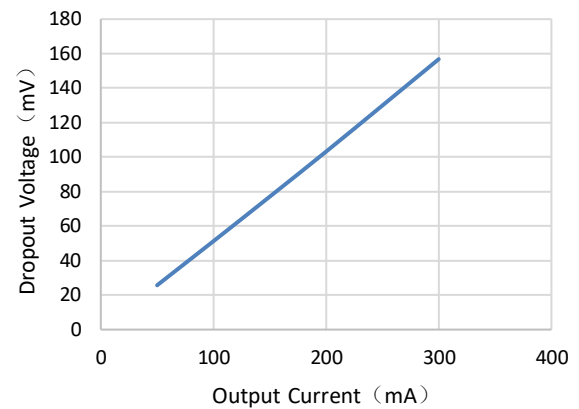

**CH1:V<sub>IN</sub>**
**CH2:V<sub>OUT</sub>**
**CH3:EN**
**CH4:I<sub>OUT</sub>**
**EN ON/OFF**

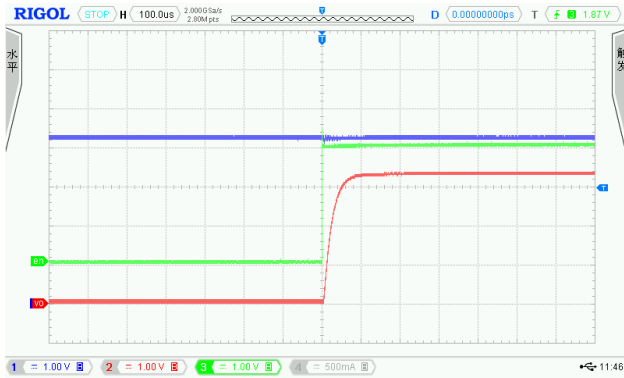
 EN=0V to 3V, I<sub>OUT</sub>=10mA

 EN=3V to 0V, I<sub>OUT</sub>=10mA

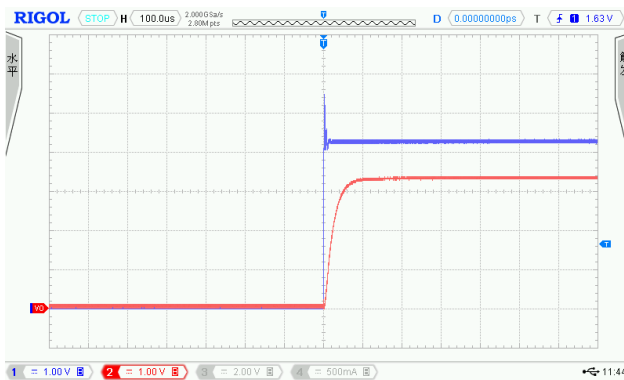
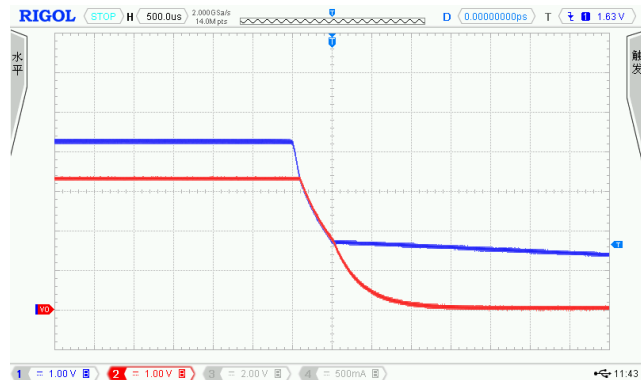
**POWER ON/OFF**

 V<sub>IN</sub>=0V to 4.3V, I<sub>OUT</sub>=10mA

 V<sub>IN</sub>=4.3V to 0V, I<sub>OUT</sub>=10mA

**LINE TRANSIENT**

 V<sub>IN</sub>=4.3V to 5.3V, I<sub>OUT</sub>=10mA

 V<sub>IN</sub>=5.3V to 4.3V, I<sub>OUT</sub>=10mA

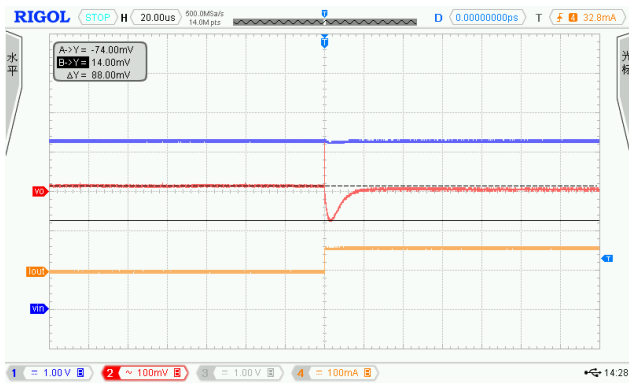
## LOAD TRANSIENT

$V_{IN}=4.3V, I_{OUT}=1mA \text{ to } 60mA$



$V_{IN}=4.3V, I_{OUT}=60mA \text{ to } 1mA$

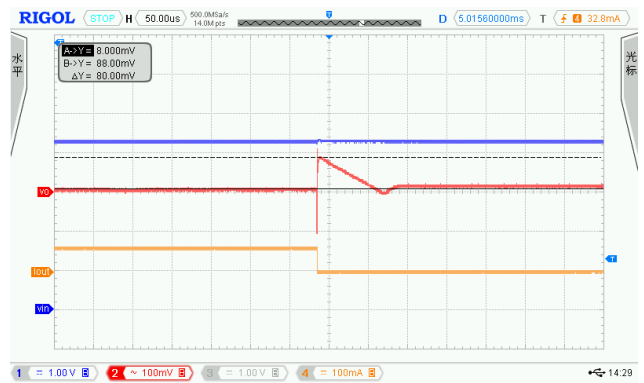

$V_{IN}=4.3V, I_{OUT}=1mA \text{ to } 200mA$

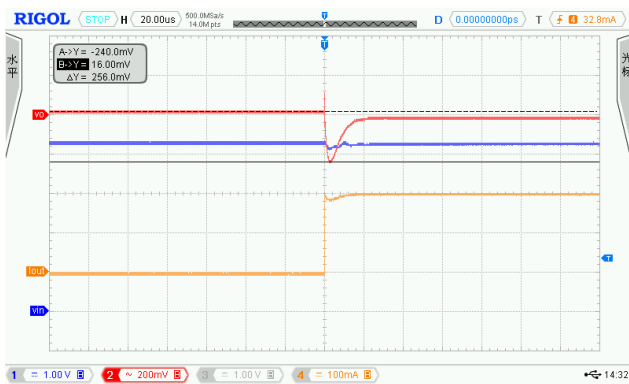

$V_{IN}=4.3V, I_{OUT}=200mA \text{ to } 1mA$

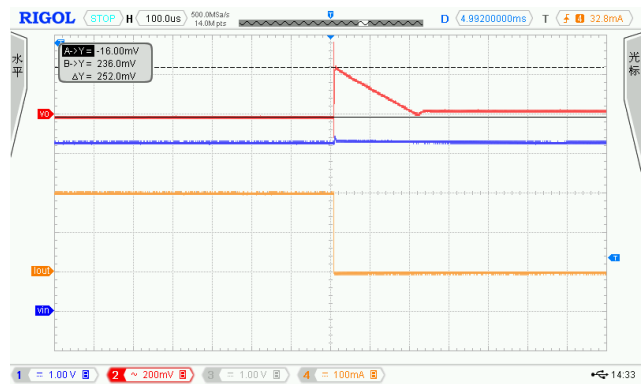

## PACKAGE OUTLINE

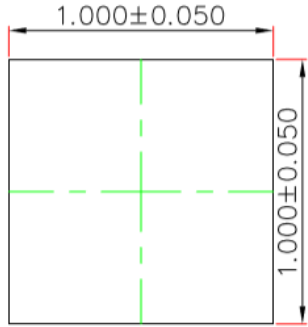
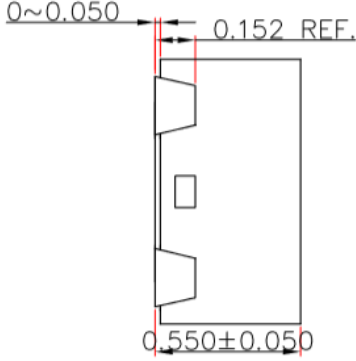
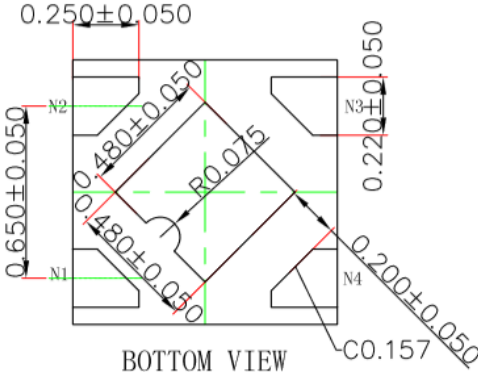
Package	DFN1x1-4L	Devices per reel	10000Pcs	Unit	mm
Package Dimension:					
 <p style="text-align: center;">TOP VIEW [顶视图]</p>		 <p style="text-align: center;">SIDE VIEW 侧视图</p>			
 <p style="text-align: center;">BOTTOM VIEW 背视图</p>					