



STK8BA58

Digital Output 3-axis MEMS Accelerometer

Datasheet

Version – 1.0

2019/11/26

CONFIDENTIAL

Hazardous Substance Free

RoHS / REACH Compliant

Sensortek Technology Corporation

1. OVERVIEW

Description

The STK8BA58 is a $\pm 2g/\pm 4g/\pm 8g$, 3-axis linear accelerometer, with digital output (I²C). It is a low profile capacitive MEMS sensor featuring, compensation for 0g offset and gain errors, and conversion to 12-bit digital values at user configurable samples per second. The device can be arranged for sensor data changes through the interrupt pins. The STK8BA58 is available in a small 2.0mm x 2.0mm x 1.0 mm LGA package and it is guaranteed to operate over an extended temperature range from -40 °C to +85 °C.

Feature

- Low Voltage Operation:
 - Supply Internal Domain Voltage: 1.7V~3.6V
 - I/O Voltage Range: 1.62V~3.6V
- $\pm 2g/\pm 4g/\pm 8g$ dynamically selectable full-scale
- I²C digital output interface
- Low noise
- 12 bit data output
- 10000 g high shock survivability
- 2.0mm x 2.0mm x 1.0 mm LGA Package
- Configurable Samples from 14 to 2000 samples per second
- Sleep Feature for Low Power Consumption
- On-chip interrupt controller, motion-triggered interrupt-signal generation for
 - New data
 - Any-motion (slope) detection
 - Significant motion
- RoHS Compliant
- Halogen Free
- Environmentally Preferred Product
- Moisture Sensitivity Level 3

Applications

- Display orientation
- Gaming and virtual reality input devices
- Impact recognition and logging
- Vibration monitoring and compensation
- Pedometer
- Activity trackers for fitness apps
- Smart power management for mobile devices

2. PIN DESCRIPTION

Pin#	Name	Dir.	Function
1	NC	NC	Not Internally Connected.
2	SDA	B	Serial Data (I ² C, Open-Drain)
3	VDDIO	PWR	Digital Interface Supply Voltage.
4	Reserved	I	Recommended tie to GND.
5	INT1	O	Interrupt 1 Output.
6	NC	NC	Not Internally Connected.
7	VS	PWR	Supply Voltage.
8	GNDIO	GND	Must be connected to ground.
9	GND	GND	Must be connected to ground.
10	NC	NC	Not Internally Connected.
11	NC	NC	Not Internally Connected.
12	SCL	I	Serial Communications Clock (I ² C, Open-Drain)

Direction denotation:

O	Output	GND	Ground
I	Input	B	Bi-direction
PWR	Power	NC	Not Connected

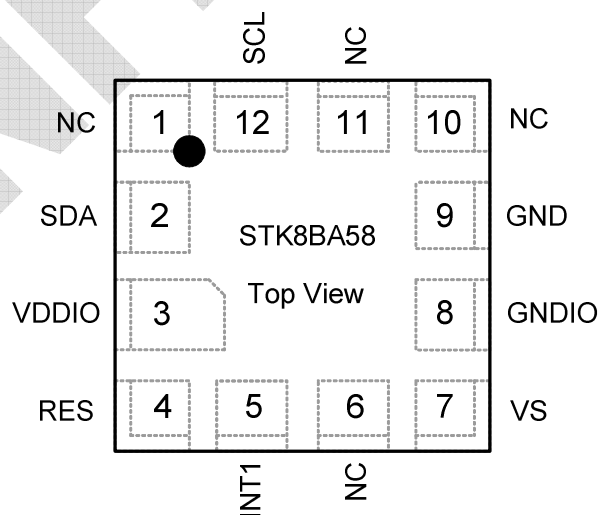

3. FUNCTION BLOCK

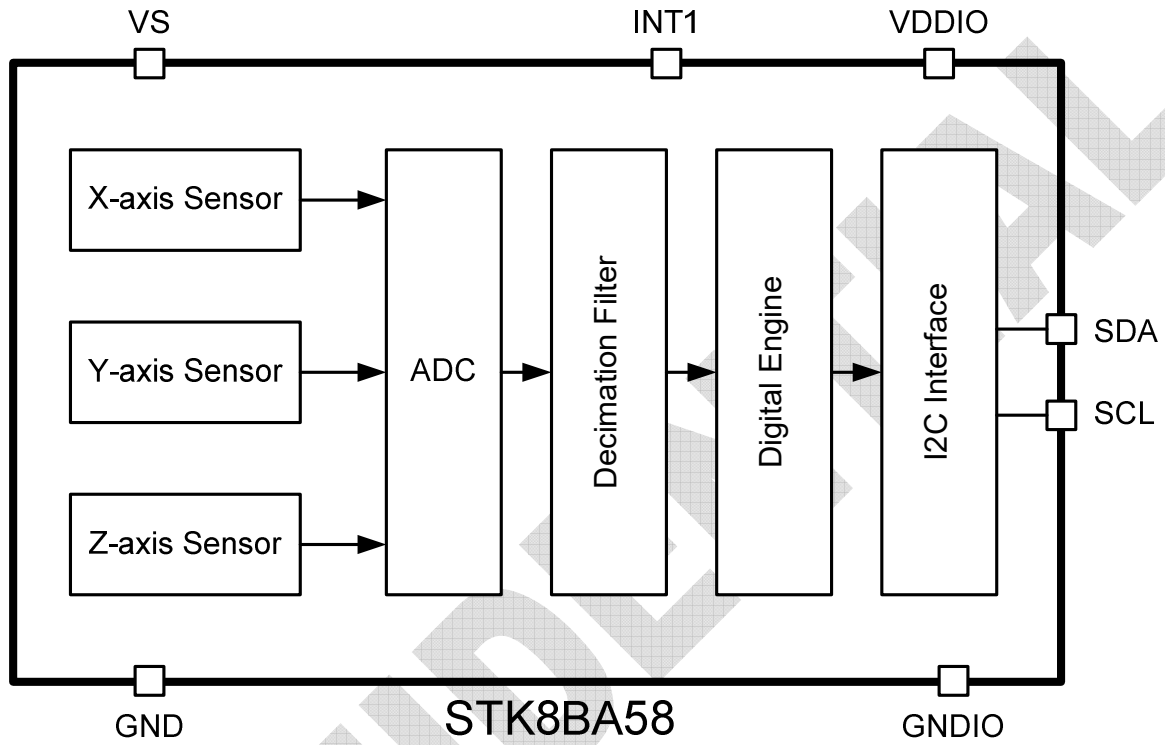

4. ELECTRICAL SPECIFICATIONS

$T_A = 25^\circ\text{C}$, $V_S = 2.6\text{ V}$, $V_{DDIO} = 2.6\text{ V}$, acceleration = 0 g, $C_S = C_{I/O} = 10\ \mu\text{F}$ and $0.1\ \mu\text{F}$

Parameter	Test Conditions	Min	Typ	Max	Unit
POWER SUPPLY					
Operating Voltage Range (VS)		1.7	2.6	3.6	V
Interface Voltage Range (VDDIO)		1.62	2.6	3.6	V
Current consumption in normal mode			110		μA
Current consumption in suspend mode			1		μA
Current consumption in low-power mode	Sleep duration=25 ms Bandwidth=1k Hz		7		μA
Start-Up Time	POR Bandwidth=1k Hz		3		ms
Digital high level input voltage (VIH)		0.7 x VDDIO			V
Digital low level input voltage (VIL)				0.3 x VDDIO	V
High level output voltage (VOH) ¹		0.8 x VDDIO			V
Low level output voltage (VOL) ¹				0.2 x VDDIO	V
OUTPUT DATA RATE AND BANDWIDTH					
	Each axis				
Bandwidth (BW)			7.81		Hz
			15.63		Hz
			31.25		Hz
			62.5		Hz
			125		Hz
			250		Hz
			500		Hz
			1000		Hz
Output data rate (ODR) in normal mode			BW * 2		Hz

1. $I_{OL} = 10\text{mA}$, $I_{OH} = -4\text{mA}$

5. MECHANICAL SPECIFICATIONS

$T_A = 25^\circ\text{C}$, $V_S = 2.6\text{ V}$, $V_{DDIO} = 2.6\text{ V}$, acceleration = 0 g, $C_S = C_{I/O} = 10\ \mu\text{F}$ and $0.1\ \mu\text{F}$

Parameter	Test Conditions	Min	Typical	Max	Unit
SENSOR INPUT	Each axis				
Measurement Range	User selectable		$\pm 2, \pm 4, \pm 8$		g
Non-linearity	Percentage of full scale		± 0.5		%FS
Cross-Axis Sensitivity			1		%
OUTPUT RESOLUTION	Each axis				
$\pm 2\text{ g}$ Range	Full resolution		12		Bits
$\pm 4\text{ g}$ Range	Full resolution		12		Bits
$\pm 8\text{ g}$ Range	Full resolution		12		Bits
SENSITIVITY	Each axis				
Sensitivity at XOUT, YOUT, ZOUT	$\pm 2\text{g}$, 12-bit resolution		1024		LSB/g
	$\pm 4\text{g}$, 12-bit resolution		512		LSB/g
	$\pm 8\text{g}$, 12-bit resolution		256		LSB/g
Sensitivity Change Due to Temperature	X-, Y-, Z-Axes		± 0.02		%/°C
0 g OFFSET ¹	Each axis				
0 g Output for XOUT, YOUT, ZOUT			± 100		mg
0 g Offset Change Due to Temperature	X-, Y-, Z-Axes		± 1		mg/°C
NOISE					
X-, Y-, Z-Axes	$\pm 2\text{g}$, 12-bit resolution Bandwidth = 1k Hz		200		$\mu\text{g}/\sqrt{\text{Hz}}$

1. These parameters are tested in production at final test, and could slightly change after mounting the sensor onto a printed circuit board or exposing it to extensive mechanical stress.

6. ABSOLUTE MAXIMUM RATINGS

Symbol	Ratings	Maximum value	Unit
VS	Supply voltage	-0.3 to 3.6	V
VDDIO	Digital Interface Supply Voltage	-0.3 to 3.6	V
Vin	Input voltage on any control pin	-0.3 to 3.6	V
A _{UNP}	Acceleration (any axis, unpowered)	10000	g
T _{OP}	Operating temperature range	-40 to +85	°C
T _{STG}	Storage temperature range	-40 to +125	°C
ESD	Electrostatic discharge protection	2 (HBM)	kV
		500 (CDM)	V
		200 (MM)	V
		100 (Latch Up)	mA

7. DIGITAL INTERFACE

I²C digital interface are available in STK8BA53. In the cases, the STK8BA58 operates as a slave device.

7.1 I²C

All registers in STK8BA58 can be accessed via the I²C bus. All operations can be controlled by the related registers. There are two signals associated with the I²C bus: the serial clock line (SCL) and the serial data line (SDA). The latter is a bidirectional signal used for sending and receiving the data to/from the interface. Both signals are pull-up to V_{DD I/O} through an external resistor.

A watchdog timer (WDT) is used to prevent the I²C bus lock-up by STK8BA53. The I²C bus will be reset and return to normal operation state once the WDT is reached. The WDT can be enabled/disabled by I2C_WDT_EN bit and the timer period can be set by I2C_WDT_SEL bit in register [INTFCFG](#) (0x34).

The STK8BA58 I²C command format description for reading and writing operation between the host and STK8BA58 are shown in the following timing chart.

Slave Address

Slave Address (7-bit)	R/W Command Bit	OPERATION
0x18	0	Write Data to STK8BA53
	1	Read Data form STK8BA53

Characteristics of the I²C Timing

Symbol	Parameter	Standard Mode		Fast Mode		Unit
		Min.	Max.	Min.	Max.	
f _{SCLK}	SCL clock frequency	10	100	10	400	KHz
t _{HDSTA}	Hold time after (repeated) start condition. After this period, the first clock is generated	4.0	—	0.6	—	μs
t _{LOW}	LOW period of the SCL clock	4.7	—	1.3	—	μs

t_{HIGH}	HIGH period of the SCL clock	4.0	—	0.6	—	μs
t_{SUSTA}	Set-up time for a repeated START condition	4.7	—	0.6	—	μs
t_{HDDAT}	Data hold time	0	—	0	—	ns
t_{SUDAT}	Data set-up time	250	—	100	—	ns
t_r	Rise time of both SDA and SCL signals	—	1000	—	300	ns
t_f	Fall time of both SDA and SCL signals	—	300	—	300	ns
t_{SUSTO}	Set-up time for STOP condition	4.0	—	0.6	—	μs
t_{BUF}	Bus free time between a STOP and START condition	4.7	—	1.3	—	μs

Note: f_{SCLK} is the $(t_{SCLK})^{-1}$.

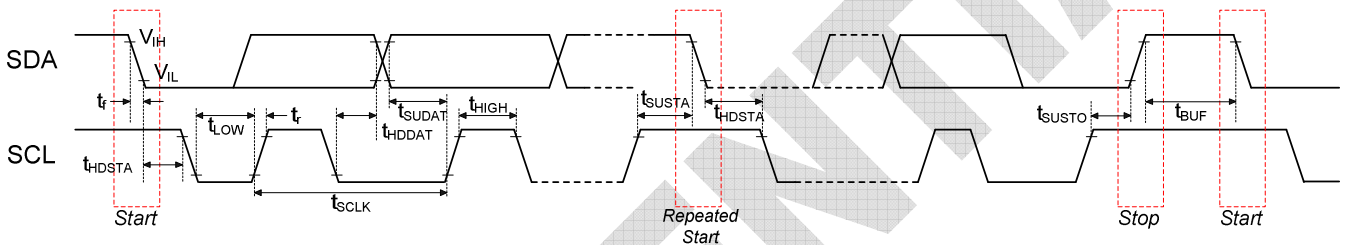

Timing Chart of the I²C

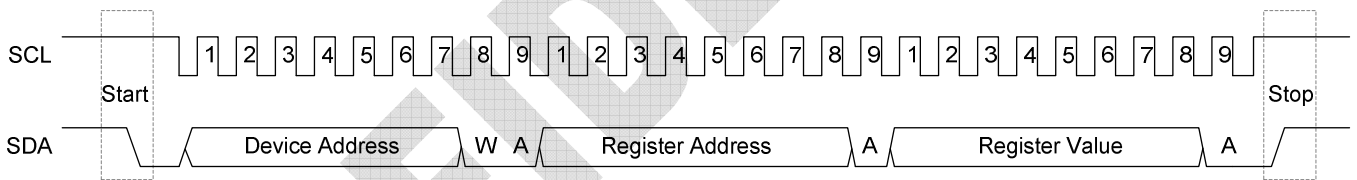

Write Command

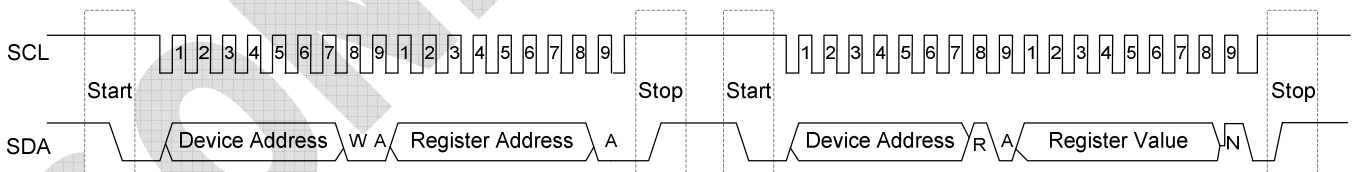

Read Data

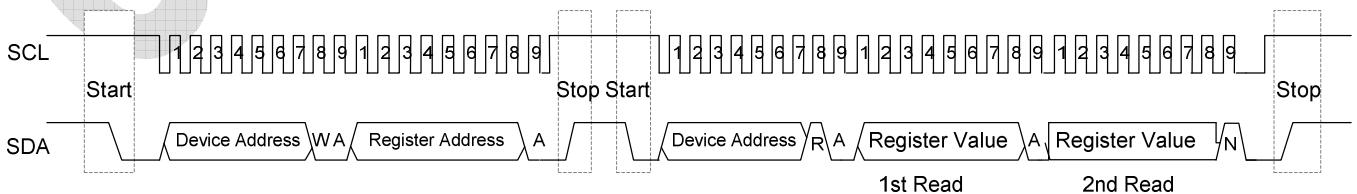

Sequential Read Data

8. PRINIPICLE OF OPERATION

8.1 Mode of Operation

STK8BA58 acts as a slave and can communicate with a master (uC or uP). Acceleration data and status information can be accessed with I²C interface. The interrupt pin are freely configured by user, depends on different requirements.

8.2 Power Management

STK8BA58 has three different power modes, Normal Mode, Low-Power Mode and Suspend Mode. After power-on, it will enter Normal Mode, and user can transfer to Low-Power Mode or Suspend Mode for power-saving purpose.

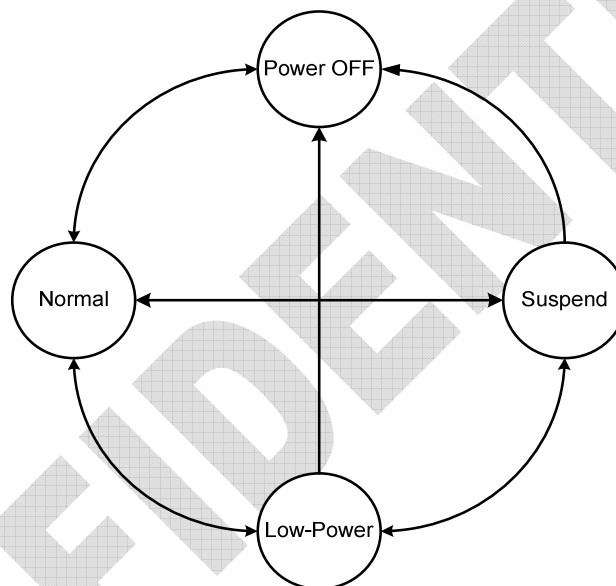

In **Normal Mode**, all functions are available and data acquisition is performed continuously.

In **Suspend Mode**, whole analog and oscillator are power-down. No data acquisition is performed. Only register reading and writing to SUSPEND bit in register [POWMODE](#) (0x11) or register [SWRST](#) (0x14) are supported. Suspend mode can be entered by set SUSPEND bit in register [POWMODE](#) (0x11) to 1. In the suspend mode, the output data doesn't clear or update, but keeps the last value before entering into suspend mode.

In **Low-Power Mode**, STK8BA58 will switch between wake-up and sleep phase. In wake-up phase, the device is full functional operation, just like in Normal Mode, and in sleep phase, the analog circuit is power-down except oscillator. During the wake-up phase, enabled interrupts are processed normally. If an interrupt is detected, device will stay in wake-up phase as long as the interrupt condition endures (non-latched interrupt), or until the latch time expires (temporary interrupt), or until the interrupt is reset (latched interrupt). If no interrupt is detected, the device enters the sleep phase automatically. Average current consumption can be effectively reduced by entering low-power mode. Low-power mode can be entered by setting LOWPOWER bit in register [POWMODE](#) (0x11) to 1.

The duration of sleep phase can be set by SLEEP_DUR [3:0] in register [POWMODE](#) (0x11).

SLEEP_DUR[3:0]	Duration (ms)	Actually ODR with 1kHz bandwidth (Hz)
4'b0000 ~ 4'b0101	0.5	295
4'b0110	1	255
4'b0111	2	202
4'b1000	4	140
4'b1001	6	110
4'b1010	10	75
4'b1011	25	34
4'b1100	50	18
4'b1101	100	10
4'b1110	500	2
4'b1111	1000	1

8.3 Data, Range and Bandwidth

Acceleration Data

The acceleration data of STK8BA58 is 12 bit and is given in two's complement format. The MSB in each axis will be stored in register [XOUT2/YOUT2/ZOUT2](#) (0x03, 0x05, 0x07) individually, and the LSB will be stored in register [XOUT1/YOUT1/ZOUT1](#) (0x02, 0x04, 0x06) individually. The NEW_X/NEW_Y/NEW_Z bit in register [XOUT1/YOUT1/ZOUT1](#) (0x02, 0x04, 0x06) is used for new data flag, and it will be set to 1 if the data is updated, and reset if either the corresponding MSB or LSB is read. Reading the acceleration data registers shall always start with the LSB part due to the data protection function. When data protection function is enabled, the content of an MSB register will be updated by reading the corresponding LSB register. The data protection function can be disabled (enabled) by writing '1' ('0') to the PROTECT_DIS bit in register [DATASETUP](#) (0x13). With disabled data protection, the content of both MSB and LSB registers is updated by a new value immediately.

Range

The STK8BA58 supports four different acceleration measurement ranges. A measurement range can be selected by RANGE[3:0] bits in register [RANGESEL](#) (0x0F).

RANGE[3:0]	Sensing Range	Resolution
4'b0011	±2g	0.98 mg/LSB
4'b0101	±4g	1.95 mg/LSB
4'b1000	±8g	3.91 mg/LSB
others	undefined	undefined

Bandwidth

There are two different data stream of STK8BA53, unfiltered data and filtered data. Unfiltered data is sampled as 2 kHz, and the sample rate of filtered data depends on the selected bandwidth; it is twice of the bandwidth. If the DATA_SEL bit in register [DATASETUP](#) (0x13) is set to '0' ('1'), the filtered (unfiltered) data will be stored in the XOUT/YOUT/ZOUT data register. Each of the data stream can be separately offset-compensated, and also can be the data source of interrupts controller. The actual bandwidth for the filtered data can be selected by BW [4:0] bits in register [BWSEL](#) (0x10).

BW[4:0]	Actual Bandwidth (Hz)
5'b00xxx	7.81
5'b01000	7.81
5'b01001	15.63
5'b01010	31.25
5'b01011	62.5
5'b01100	125
5'b01101	250
5'b01110	500
5'b01111	1000
5'b1xxxx	1000

8.4 Motion Algorithm Status and Interrupt Event Detection

The following table shows the interrupt events offered by STK8BA53. Two interrupt engines and one INT pins are integrated for conveniently motion detection. Each interrupt could be enabled independently, and mapped into the INT pin. If the condition of enabled interrupt is fulfilled, the corresponding status is set to '1' and the INT pin is asserted. The INT pin state is logical 'or' combination of all mapped interrupts. The INT pin state is logical 'or' combination of all mapped interrupts. If an interrupt is disabled, all active pins and status are reset immediately.

Two motion algorithms, any-motion and significant motion, used for detecting user movement can flexibly choose three independent axes as the data source via register [INTEN1](#) (0x16), and the event signal is triggered by an "OR" combination of the enabled axes.

Interrupt Event	Control Bit	Status Bit in Register INTSTS1/2 (0x09, 0x0A)
New Data	DATA_EN in INTEN2 (0x17)	DATA_STS
Any-Motion (Slope) Significant Motion	SLP_EN_Z in INTEN1 (0x16)	ANY_MOT_STS
	SLP_EN_Y in INTEN1 (0x16)	SIG_MOT_STS
	SLP_EN_X in INTEN1 (0x16)	ANY_MOT_STS
	ANY_MOT_EN in SIGMOT2 (0x2A)	SIG_MOT_STS
	SIG_MOT_EN in SIGMOT2 (0x2A)	SIG_MOT_STS

Note: Motion algorithm engine follows the logic shown below.

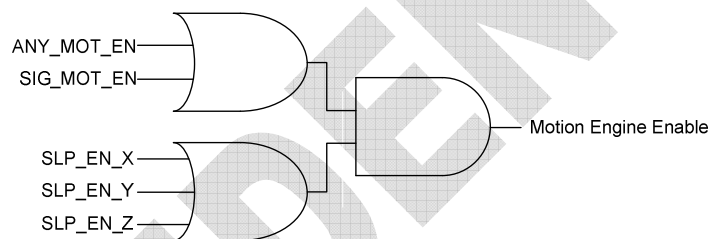

Interrupt Latch Mode

There are three different interrupt latch modes of Any-Motion (Slope) and Significant Motion: non-latched, temporary, and latched. The modes can be selected by the INT_LATCH [3:0] bits in register [INTCFG2](#) (0x21). The following table shows the different configurations of interrupt modes in INT_LATCH [3:0].

Note: Interrupt latched mode INT_LATCH [3:0] in register [INTCFG2](#) (0x21) can not be default setting after motion algorithms enabled. Interrupt latched mode must be set in the initial configuration.

INT_LATCH[3:0]	Output Mode
4'b0000	non-latched
4'b0001	temporary, 250ms
4'b0010	temporary, 500ms
4'b0011	temporary, 1s
4'b0100	temporary, 2s
4'b0101	temporary, 4s
4'b0110	temporary, 8s
4'b0111	latched
4'b1000	non-latched
4'b1001	temporary, 250us
4'b1010	temporary, 500us
4'b1011	temporary, 1ms
4'b1100	temporary, 12.5ms
4'b1101	temporary, 25ms
4'b1110	temporary, 50ms
4'b1111	latched

In the **non-latched mode**, the corresponding status and mapped INT pin are clear as soon as the activation condition is no more valid.

In the **latched mode**, the status and mapped INT pins are cleared only by setting '1' to the INT_RST bit in register [INTCFG2](#) (0x21). If the activation condition still holds when it is cleared, the interrupt pin and status will be both asserted again.

In the **temporary mode**, an asserted interrupt and selected pin are cleared after a defined period of time. The following figure shows the behavior of three interrupt modes.

Both filtered and unfiltered data could be the data source of the interrupt events. Setting the corresponding bit in register [DATASETUP](#) (0x13) to '0'('1') will select the filtered(unfiltered) data as the data source for interrupt events.

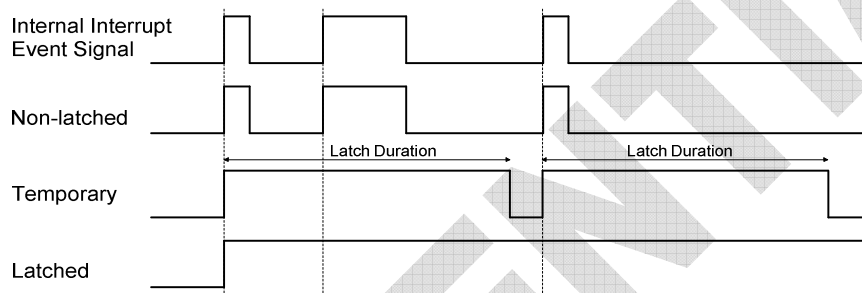

Interrupt latch mode control bits only apply to Any-Motion (Slope) and Significant Motion. Other interrupt events are fixed to their own latch mode, which are shown in the following table.

Interrupt Event	Type	Latch mode	Clear
New data	Status	Non-latch	Auto clear after 250us
Any-Motion (Slope)	Programmable	Programmable	Based on configuration
Significant Motion	Programmable	Programmable	Based on configuration

Interrupt Pin Mapping

The mapping of interrupts to the INT1 is controlled by registers [INTMAP2](#) (0x1A). Setting the corresponding bit to '1'('0') maps(un-maps) the related interrupt to the INT1 pin.

INT Pin Output Type and Active Level

INT1 could be configured as Push-Pull/Open-Drain output and the active level could also be set as active-high/activelow. The related bits in register [INTCFG1](#) (0x20) are used to select the INT1 output type and active level.

8.5 Offset Compensation

Manual Compensation

STK8BA58 offers the manual digital offset-compensation method. It is done by adding a compensation value to the acceleration data coming from the ADC. The registers [OFSTX/Y/Z](#) (0x38, 0x39, 0x3A) are used to for the offset compensation purpose and are given in two's complement format. 1 LSB of OFSTX/Y/Z represents 7.81mg in any sensing range.

By writing '1' to the OFST_RST bit in register [OFSTCOMP1](#) (0x36), all offset compensation registers are reset to zero.

It is recommended to write into these registers immediately after a new data interrupt in order not to disturb running offset computations.

9. REGISTER DEFINATION

9.1 Register Map

ADDR	REG NAME	BIT								Default	
		7	6	5	4	3	2	1	0		
00h	CHIP_ID	CHIP_ID[7:0]								87h	
01h	RESERVED	reserved								00h	
02h	XOUT1	XOUT[3:0]				reserved			NEW_X	00h	
03h	XOUT2	XOUT[11:4]								00h	
04h	YOUT1	YOUT[3:0]				reserved			NEW_Y	00h	
05h	YOUT2	YOUT[11:4]								00h	
06h	ZOUT1	ZOUT[3:0]				reserved			NEW_Z	00h	
07h	ZOUT2	ZOUT[11:4]								00h	
08h	RESERVED	reserved								00h	
09h	INTSTS1	reserved					ANY_MOT_STS	reserved	SIG_MOT_STS	00h	
0Ah	INTSTS2	DATA_STS	reserved								00h
0Bh	EVENTINFO1	reserved	SLPSIGN_Z	SLPSIGN_Y	SLPSIGN_X	reserved	SLP_1ST_Z	SLP_1ST_Y	SLP_1ST_X	00h	
0Ch-0Eh	RESERVED	reserved								00h	
0Fh	RANGESEL	reserved				RANGE[3:0]				03h	
10h	BWSEL	reserved				BW[4:0]				1Fh	
11h	POWMODE	SUSPEND	LOWPOWER	reserved	SLEEP_DUR[3:0]			reserved	00h		
12h	RESERVED	reserved								00h	
13h	DATASETUP	DATA_SEL	PROTECT_DIS	reserved						00h	
14h	SWRST	SWRST[7:0]								00h	
15h	RESERVED	reserved								00h	
16h	INTEN1	reserved					SLP_EN_Z	SLP_EN_Y	SLP_EN_X	00h	
17h	INTEN2	reserved			DATA_EN	reserved				00h	
18h	RESERVED	reserved								00h	
19h	INTMAP1	reserved					ANYMOT2INT1	reserved	SIGMOT2INT1	00h	
1Ah	INTMAP2	reserved							DATA2INT1		
1Bh-1Fh	RESERVED	reserved								00h	
20h	INTCFG1	reserved						INT1_OD	INT1_LV	01h	
21h	INTCFG2	INT_RST	reserved			INT_LATCH[3:0]				00h	
22h-26h	RESERVED	reserved								00h	
27h	SLOPEDLY	reserved						SLP_DUR[1:0]		00h	
28h	SLOPETHD	SLP_THD[7:0]								14h	
29h	SIGMOT1	SKIP_TIME[7:0]								96h	
2Ah	SIGMOT2	reserved					ANY_MOT_EN	SIG_MOT_EN	SKIP_TIME[8]	02h	
2Bh	SIGMOT3	reserved	PROOF_TIME[6:0]							32h	
2Ch-33h	RESERVED	reserved								00h	
34h	INTFCFG	reserved					I2C_WDT_EN	I2C_WDT_SEL	reserved	00h	
35h	RESERVED	reserved								00h	
36h	OFSTCOMP1	OFST_RST	reserved							00h	

37h	RESERVED	reserved	00h
38h	OFSTX	OFST_X[7:0]	00h
39h	OFSTY	OFST_Y[7:0]	00h
3Ah	OFSTZ	OFST_Z[7:0]	00h

9.2 Register Description

CHIP_ID Register (00h)

b7	b6	b5	b4	b3	b2	b1	b0
CHIP_ID[7:0]							
8'b10000111							
RO							

The register contains the chip identification code.

XOUT1 Register (02h)

b7	b6	b5	b4	b3	b2	b1	b0
XOUT[3:0]				reserved			NEW_X
4'b0000				3'b000			0
RO				RO			RO

XOUT1/XOUT2 register contain the x-axis acceleration data and the new data flag for the x-axis.

XOUT2 Register (03h)

b7	b6	b5	b4	b3	b2	b1	b0
XOUT[11:4]							
8'b00000000							
RO							

YOUT1 Register (04h)

b7	b6	b5	b4	b3	b2	b1	b0
YOUT[3:0]				reserved			NEW_Y
4'b0000				3'b000			0
RO				RO			RO

YOUT1/YOUT2 register contain the y-axis acceleration data and the new data flag for the y-axis.

YOUT2 Register (05h)

b7	b6	b5	b4	b3	b2	b1	b0
YOUT[11:4]							
8'b00000000							
RO							

ZOUT1 Register (06h)

b7	b6	b5	b4	b3	b2	b1	b0
ZOUT[3:0]				reserved			NEW_Z
4'b0000				3'b000			0
RO				RO			RO

ZOUT1/ZOUT2 register contain the z-axis acceleration data and the new data flag for the z-axis.

ZOUT2 Register (07h)

b7	b6	b5	b4	b3	b2	b1	b0
ZOUT[11:4]							
8'b00000000							
RO							

INTSTS1 Register (09h)

b7	b6	b5	b4	b3	b2	b1	b0
reserved					ANY_MOT_STS	reserved	SIG_MOT_STS
5'b00000					0	0	0
RO					RO	RO	RO

This register contains the interrupts status in STK8BA53.

BIT	BIT NAME	Description
0	SIG_MOT_STS	Significant motion interrupt status. '1' : event triggered, '0' : no event.
2	ANY_MOT_STS	Any-motion (slope) detection interrupt status. '1' : event triggered, '0' : no event.

INTSTS2 Register (0Ah)

b7	b6	b5	b4	b3	b2	b1	b0
DATA_STS	reserved						
0	7'b0000000						
RO	RO						

This register contains the new data interrupt status in STK8BA53.

BIT	BIT NAME	Description
7	DATA_STS	New data interrupt status. '1' : event triggered, '0' : no event.

EVENTINFO1 Register (0Bh)

b7	b6	b5	b4	b3	b2	b1	b0
reserved	SLPSIGN_Z	SLPSIGN_Y	SLPSIGN_X	reserved	SLP_1ST_Z	SLP_1ST_Y	SLP_1ST_X
0	0	0	0	0	0	0	0
RO	RO	RO	RO	RO	RO	RO	RO

This register contains any-motion (slope) detection information.

BIT	BIT NAME	Description
0	SLP_1ST_X	1 : Motion on the X-axis cause SLOPE interrupt asserted.
1	SLP_1ST_Y	1 : Motion on the Y-axis cause SLOPE interrupt asserted.
2	SLP_1ST_Z	1 : Motion on the Z-axis cause SLOPE interrupt asserted.
4	SLPSIGN_X	Sign of acceleration slope on the X-axis that triggered the SLOPE interrupt. 0 : positive. 1 : negative.
5	SLPSIGN_Y	Sign of acceleration slope on the Y-axis that triggered the SLOPE interrupt. 0 : positive. 1 : negative.
6	SLPSIGN_Z	Sign of acceleration slope on the Z-axis that triggered the SLOPE interrupt. 0 : positive. 1 : negative.

RANGESEL Register (0Fh)

b7	b6	b5	b4	b3	b2	b1	b0
reserved				RANGE[3:0]			
4'b0000				4'b0011			
RO				R/W			

This register contains the acceleration sensing range.

RANGE[3:0]	Sensing Range
4'b0011	±2g
4'b0101	±4g
4'b1000	±8g
others	undefined

BWSEL Register (10h)

b7	b6	b5	b4	b3	b2	b1	b0
reserved			BW[4:0]				
3'b000			5'b11111				
RO			R/W				

This register contains the output data bandwidth selection.

BW[4:0]	Actual Bandwidth (Hz)
5'b00xxx	7.81
5'b01000	7.81
5'b01001	15.63
5'b01010	31.25
5'b01011	62.5
5'b01100	125
5'b01101	250
5'b01110	500
5'b01111	1000
5'b1xxxx	1000

POWMODE Register (11h)

b7	b6	b5	b4	b3	b2	b1	b0
SUSPEND	LOWPOWER	reserved	SLEEP_DUR[3:0]			reserved	
0	0	0	4'b0000			0	
R/W	R/W	RO	R/W			RO	

This register contains the power mode selection and the sleep time duration setting.

BIT	BIT NAME	Description																								
[4:1]	SLEEP_DUR[3:0]	Sleep time duration. <table border="1"> <thead> <tr> <th>SLEEP_DUR[3:0]</th> <th>Duration (ms)</th> </tr> </thead> <tbody> <tr><td>4'b0000 ~ 4'b0101</td><td>0.5</td></tr> <tr><td>4'b0110</td><td>1</td></tr> <tr><td>4'b0111</td><td>2</td></tr> <tr><td>4'b1000</td><td>4</td></tr> <tr><td>4'b1001</td><td>6</td></tr> <tr><td>4'b1010</td><td>10</td></tr> <tr><td>4'b1011</td><td>25</td></tr> <tr><td>4'b1100</td><td>50</td></tr> <tr><td>4'b1101</td><td>100</td></tr> <tr><td>4'b1110</td><td>500</td></tr> <tr><td>4'b1111</td><td>1000</td></tr> </tbody> </table>	SLEEP_DUR[3:0]	Duration (ms)	4'b0000 ~ 4'b0101	0.5	4'b0110	1	4'b0111	2	4'b1000	4	4'b1001	6	4'b1010	10	4'b1011	25	4'b1100	50	4'b1101	100	4'b1110	500	4'b1111	1000
SLEEP_DUR[3:0]	Duration (ms)																									
4'b0000 ~ 4'b0101	0.5																									
4'b0110	1																									
4'b0111	2																									
4'b1000	4																									
4'b1001	6																									
4'b1010	10																									
4'b1011	25																									
4'b1100	50																									
4'b1101	100																									
4'b1110	500																									
4'b1111	1000																									
6	LOWPOWER	0 : low-power mode disable. 1 : low-power mode enable.																								
7	SUSPEND	0 : suspend mode disable. 1 : suspend mode enable.																								

DATASETUP Register (13h)

b7	b6	b5	b4	b3	b2	b1	b0
DATA_SEL	PROTECT_DIS	reserved					
0	0	6'b000000					
R/W	R/W	RO					

This register is used to select if the output data is filtered or unfiltered and how the output data contained in the register XOUT1/XOUT2, YOUT1/YOUT2, ZOUT1/ZOUT2 are updated.

BIT	BIT NAME	Description
6	PROTECT_DIS	0 : Enable the data protection function. 1 : Disable the data protection function.
7	DATA_SEL	0 : Data output filtered. 1 : Data output unfiltered.

SWRST Register (14h)

b7	b6	b5	b4	b3	b2	b1	b0
SWRST[7:0]							
8'b00000000							
W							

This register is used to software reset. Write 0xB6 into SWRST to reset all the registers to default value.

INTEN1 Register (16h)

b7	b6	b5	b4	b3	b2	b1	b0
reserved					SLP_EN_Z	SLP_EN_Y	SLP_EN_X
5'b00000					0	0	0
RO					R/W	R/W	R/W

This register contains the several interrupt enable bit.

BIT	BIT NAME	Description
0	SLP_EN_X	0 : Disable X-axis any-motion (slope) interrupt. 1 : Enable X-axis any-motion (slope) interrupt.
1	SLP_EN_Y	0 : Disable Y-axis any-motion (slope) interrupt. 1 : Enable Y-axis any-motion (slope) interrupt.
2	SLP_EN_Z	0 : Disable Z-axis any-motion (slope) interrupt. 1 : Enable Z-axis any-motion (slope) interrupt.

INTEN2 Register (17h)

b7	b6	b5	b4	b3	b2	b1	b0
Reserved			DATA_EN	reserved			
3'b000			0	4'b0000			
RO			R/W	RO			

This register contains the several interrupt enable bit.

BIT	BIT NAME	Description
4	DATA_EN	0 : Disable new data interrupt. 1 : Enable new data interrupt.

INTMAP1 Register (19h)

b7	b6	b5	b4	b3	b2	b1	b0
Reserved					ANYMOT2INT1	reserved	SIGMOT2INT1
5'b00000					0	0	0
RO					R/W	RO	R/W

This register is used to map the related interrupt to the desired INT pin.

BIT	BIT NAME	Description
0	SIGMOT2INT1	0 : Do not map significant motion interrupt to INT1. 1 : Map significant motion interrupt to INT1.
2	ANYMOT2INT1	0 : Do not map any-motion (slope) interrupt to INT1. 1 : Map any-motion (slope) interrupt to INT1.

INTMAP2 Register (1Ah)

b7	b6	b5	b4	b3	b2	b1	b0
reserved							DATA2INT1
7'b0000000							0
RO							R/W

This register is used to map the related interrupt to the desired INT pin.

BIT	BIT NAME	Description
0	DATA2INT1	0 : Do not map new data interrupt to INT1. 1 : Map new data interrupt to INT1.

INTCFG1 Register (20h)

b7	b6	b5	b4	b3	b2	b1	b0
reserved						INT1_OD	INT1_LV
6'b000000						0	1
RO						R/W	R/W

This register is used to define the INT1 pin output type and active level. Open-drain or Push-pull output type and active high or active low can be selected.

BIT	BIT NAME	Description
0	INT1_LV	INT1 active level selection. 0 : Active low. 1 : Active high.
1	INT1_OD	INT1 output type selection. 0 : Push-pull output type. 1 : Open-drain output type.

INTCFG2 Register (21h)

b7	b6	b5	b4	b3	b2	b1	b0
INT_RST	reserved			INT_LATCH[3:0]			
0	3'b000			4'b0000			
R/W	RO			R/W			

This register is used to reset latched interrupt pin and select the interrupt mode.

BIT	BIT NAME	Description																																		
[3:0]	INT_LATCH[3:0]	INT pin output mode selection. <table border="1" data-bbox="491 1400 1018 1892"> <thead> <tr> <th>INT_LATCH[3:0]</th> <th>Output Mode</th> </tr> </thead> <tbody> <tr><td>4'b0000</td><td>non-latched</td></tr> <tr><td>4'b0001</td><td>temporary, 250ms</td></tr> <tr><td>4'b0010</td><td>temporary, 500ms</td></tr> <tr><td>4'b0011</td><td>temporary, 1s</td></tr> <tr><td>4'b0100</td><td>temporary, 2s</td></tr> <tr><td>4'b0101</td><td>temporary, 4s</td></tr> <tr><td>4'b0110</td><td>temporary, 8s</td></tr> <tr><td>4'b0111</td><td>latched</td></tr> <tr><td>4'b1000</td><td>non-latched</td></tr> <tr><td>4'b1001</td><td>temporary, 250us</td></tr> <tr><td>4'b1010</td><td>temporary, 500us</td></tr> <tr><td>4'b1011</td><td>temporary, 1ms</td></tr> <tr><td>4'b1100</td><td>temporary, 12.5ms</td></tr> <tr><td>4'b1101</td><td>temporary, 25ms</td></tr> <tr><td>4'b1110</td><td>temporary, 50ms</td></tr> <tr><td>4'b1111</td><td>latched</td></tr> </tbody> </table>	INT_LATCH[3:0]	Output Mode	4'b0000	non-latched	4'b0001	temporary, 250ms	4'b0010	temporary, 500ms	4'b0011	temporary, 1s	4'b0100	temporary, 2s	4'b0101	temporary, 4s	4'b0110	temporary, 8s	4'b0111	latched	4'b1000	non-latched	4'b1001	temporary, 250us	4'b1010	temporary, 500us	4'b1011	temporary, 1ms	4'b1100	temporary, 12.5ms	4'b1101	temporary, 25ms	4'b1110	temporary, 50ms	4'b1111	latched
INT_LATCH[3:0]	Output Mode																																			
4'b0000	non-latched																																			
4'b0001	temporary, 250ms																																			
4'b0010	temporary, 500ms																																			
4'b0011	temporary, 1s																																			
4'b0100	temporary, 2s																																			
4'b0101	temporary, 4s																																			
4'b0110	temporary, 8s																																			
4'b0111	latched																																			
4'b1000	non-latched																																			
4'b1001	temporary, 250us																																			
4'b1010	temporary, 500us																																			
4'b1011	temporary, 1ms																																			
4'b1100	temporary, 12.5ms																																			
4'b1101	temporary, 25ms																																			
4'b1110	temporary, 50ms																																			
4'b1111	latched																																			
7	INT_RST	1 : Reset any latched interrupt pin.																																		

SLOPEDLY Register (27h)

b7	b6	b5	b4	b3	b2	b1	b0
reserved						SLP_DUR[1:0]	
6'b000000						2'b00	
RO						R/W	

This register is used to set the number of samples needed in slope detection. The actual number of samples will be equal to SLP_DUR[1:0] + 1.

SLOPETHD Register (28h)

b7	b6	b5	b4	b3	b2	b1	b0
SLP_THD[7:0]							
8'b00010100							
R/W							

This register is used to set the threshold value for the slope detection. The actual slope threshold will depend on sensing range. The default value of SLP_THD[7:0] is 0x14.

RANGE[3:0]	Sensing Range	Actual Slope Threshold (mg)
4'b0011	±2g	SLP_THD[7:0] * 3.91
4'b0101	±4g	SLP_THD[7:0] * 7.81
4'b1000	±8g	SLP_THD[7:0] * 15.63

SIGMOT1 Register (29h)

b7	b6	b5	b4	b3	b2	b1	b0
SKIP_TIME[7:0]							
8'b10010110							
R/W							

This register is used to set the skip time for the significant motion. Holding the duration for skip, for which the motion is checked for re-detection. 1 LSB=20 ms. Range is 0 to 10sec. The default value of SKIP_TIME[8:0] is 0x96 correspond to 3 seconds.

SIGMOT2 Register (2Ah)

b7	b6	b5	b4	b3	b2	b1	b0
reserved					ANY_MOT_EN	SIG_MOT_EN	SKIP_TIME[8]
5'b00000					0	1	0
RO					R/W	R/W	R/W

This register contains MSB of SKIP_TIME[8:0] for the significant motion, and significant motion interrupt enable bit.

BIT	BIT NAME	Description
1	SIG_MOT_EN	0 : Disable significant motion. 1 : Enable significant motion.
2	ANY_MOT_EN	0 : Disable any-motion. 1 : Enable any-motion.

SIGMOT3 Register (2Bh)

b7	b6	b5	b4	b3	b2	b1	b0
reserved				PROOF_TIME[7:0]			
0				7'b0110010			
RO				R/W			

This register is used to set the proof time for the significant motion. Holding the duration for proof, for which the motion is re-checked after. 1 LSB=20 ms. Range is 0 to 2.5sec. The default value of PROOF_TIME[8:0] is 0x32 correspond to 1 seconds.

INTFCFG Register (34h)

b7	b6	b5	b4	b3	b2	b1	b0
reserved					I2C_WDT_EN	I2C_WDT_SEL	reserved
5'b00000					0	0	0
RO					R/W	R/W	RO

This register contains the digital interface parameters for the I²C interface.

BIT	BIT NAME	Description
1	I2C_WDT_SEL	I ² C watchdog timer period selection. 0 : Watchdog timer period 1ms. 1 : Watchdog timer period 50ms.
2	I2C_WDT_EN	I ² C watchdog timer enable bit. 0 : Disable I2C watchdog timer. 1 : Enable I2C watchdog timer.

OFSTCOMP1 Register (36h)

b7	b6	b5	b4	b3	b2	b1	b0
OFST_RST	reserved						
0	2'b0000000						
W	R						

This register is used to define the setting for the offset compensation.

BIT	BIT NAME	Description
7	OFST_RST	1 : Reset all the offset compensation register (register 0x38 ~ 0x3A) to zero.

OFSTX Register (38h)

B7	b6	b5	b4	b3	b2	b1	b0
OFST_X[7:0]							
8'b00000000							
R/W							

This register contains the offset compensation value for the x-axis data output.

OFSTY Register (39h)

B7	b6	b5	b4	b3	b2	b1	b0
OFST_Y[7:0]							
8'b00000000							
R/W							

This register contains the offset compensation value for the y-axis data output.

OFSTZ Register (3Ah)

b7	b6	b5	b4	b3	b2	b1	b0
OFST_Z[7:0]							
8'b00000000							
R/W							

This register contains the offset compensation value for the z-axis data output.

Register 0x38 to 0x3A can be modified manually set by user. The value in these register will be added to the actual acceleration data sensing by STK8BA58 and store the new value to XOUT/YOUT/ZOUT register.

10. APPLICATION INFORMATION

10.1 New Data Interrupt

This interrupt serves for synchronous reading of acceleration data. It is generated after storing a new value of z-axis acceleration data in the data register. The interrupt is cleared automatically when the next cycle of data acquisition starts. The interrupt status is '0' for at least 50 μ s. The interrupt mode of the new data interrupt is fixed to non-latched for at least 250 us.

Control Register	Bit Name	Function
INTEN2 [4]	DATA_EN	'1': enabled, '0': disabled, and the interrupt mode is fixed to non-latched.
INTSTS [7]	DATA_STS	The interrupt status.
INTMAP2	DATA2INT1	New data interrupt maps to INT1.
DATASETUP [5]	DATA_SEL	'1': unfiltered data, '0': filtered data, as the input of the new data interrupt.

10.2 Any-motion (Slope) Detection

Any-motion (slope) detection is to detect the change of motion. By monitoring the slop of acceleration, user can estimate the variation of acceleration. STK8BA58 use the slop between successive acceleration data to detect it, and would active the interrupt when the slop exceeds a preset threshold. Moreover, a duration setting has to be configured to suppress failure signals. The following figure shows the relationship between acceleration data, acceleration slop, and INT status. If a certain number N of consecutive slope data points is larger (smaller) than the slope threshold, the INT would be trigger (clear).

One LSB of SLP_THD [7:0] represents 1 LSB of acceleration data, and it depends on which sensing range is set. For Example, 3.91mg in 2g-range, 7.81 mg in 4g-range, 15.6 mg in 8g-range and 31.3 mg in 16g-range. The consecutive slope data points are set by SLP_DUR [1:0], and is equal to (SLP_DUR [1:0] + 1). The time difference between the successive acceleration signals depends on the selected bandwidth and equates to $1/(2*\text{bandwidth})$.

Any-motion (slope) detection can be enabled by writing '1' to ANY_MOT_EN bit in the register [SIGMOT2](#) (0x2A). Furthermore, user must select which axes are enabled independently by writing '1' to the bit SLP_EN_X, SLP_EN_Y, and SLP_EN_Z in the register [INTEN1](#) (0x16).

If slope of any axis fulfills the specified condition, INT pin would be triggered, interrupt status would be updated to ANY_MOT_STS, and the sign of slop would be shown in SLPSIGN_X, SLPSIGN_Y, SLPSIGN_Z. Moreover, SLP_1ST_X, SLP_1ST_Y, and SLP_1ST_Z would indicate which axis is the first axis triggering the interrupt of slop detection.

Control Register	Bit Name	Function
INTEN1 [0]	SLP_EN_X	Slope detection enable for X-axis, '1': enabled, '0': disabled for Y-axis, '1': enabled, '0': disabled for Z-axis, '1': enabled, '0': disabled
INTEN1 [1]	SLP_EN_Y	
INTEN1 [2]	SLP_EN_Z	
SIGMOT2 [2]	ANY_MOT_EN	Any-motion enable bit. 0: Disabled. 1: Enabled.
SLOPETHD [7:0]	SLP_THD	Slope threshold, 1LSB=1LSB of XOUT/YOUT/ZOUT
SLOPEDLY [1:0]	SLP_DUR	Slope duration, 1LSB= $1/(2*\text{bandwidth})$
INTMAP1	ANTMOT2INT1	Slope detection interrupt maps to INT1
INTSTS1 [2]	ANT_MOT_STS	Slope detection status which is synchronized with INT1 activity
DATASETUP [7]	DATA_SEL	'1': unfiltered data, '0': filtered data, as the input of the slop detection
EVENTINFO1 [0]	SLP_1ST_X	'1': triggered axis, '0': not triggered
EVENTINFO1 [1]	SLP_1ST_Y	
EVENTINFO1 [2]	SLP_1ST_Z	
EVENTINFO1 [4]	SLPSIGN_X	Sign of slope when interrupt is triggered, '0': Positive, '1': Negative
EVENTINFO1 [5]	SLPSIGN_Y	
EVENTINFO1 [6]	SLPSIGN_Z	

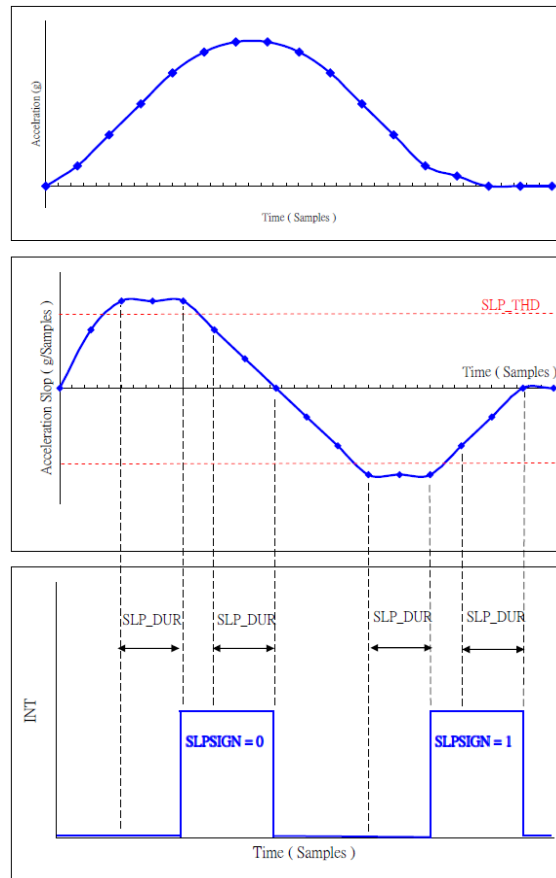

Note1: In order to ensure motion algorithm working normally, interrupt latched mode must be set before motion algorithms enabled.

Note2: It's not recommended that motion algorithm working in the low-power mode and set BW less than 1k Hz simultaneously.

10.3 Significant Motion

The significant motion is defined as some activities that might lead to a change in a user's location. Examples of significant motions are walking or biking, sitting in a moving car, coach or train, etc. Examples of situations that should not trigger significant motion include phone in pocket and person is not moving, phone is on a table and the table shakes a bit due to nearby traffic or washing machine. For more information, please refer to Android Sensor types: https://source.android.com/devices/sensors/sensor-types.html#significant_motion.

Significant motion function would be triggered by means of monitoring the slope of acceleration over a period of time. The algorithm will be started when a motion is detected, and generates a signal if another motion is detected after the SKIP_TIME[8:0] (0x29-0x2A) and within the PROOF_TIME[7:0] (0x2B). Both 1 LSB of skip time and proof time correspond to 20ms.

The significant motion and slope detection share event-triggered settings including independent XYZ-axes slope enable bit [INTEN1](#) [2:0] (0x16), threshold SLOPETHD [7:0] (0x28), duration SLOPEDLY [1:0] (0x27). User should be noticed that the slope detection has to be enabled before enabling significant motion due to a sharing algorithm engine. Then enable significant motion by writing '1' to SIG_MOT_EN bit in register [SIGMOT2](#) (0x2A).

Follow the steps below to enable significant motion:

- Step1.** (MUST) Set interrupt configurations INTCFG1 (0x20) and INTCFG2 (0x21).
- Step2.** Set configuration settings include SKIP_TIME[8:0] (0x29-0x2A), PROOF_TIME[7:0] (0x2B), SLOPEDLY[1:0] (0x27) and SLOPETHD[7:0] (0x28).
- Step3.** Set XYZ-axes slope detection enabled by INTEN1[2:0] (0x16).
- Step4.** Set significant motion enabled by SIGMOT2[1] (0x2A).
- Step5.** Mapping significant motion to physical interrupt pin by INTMAP1[0] (0x19).
- Step6.** Wait for INT triggered or monitor SIG_MOT_STS bit in INTSTS1[0] (0x09)

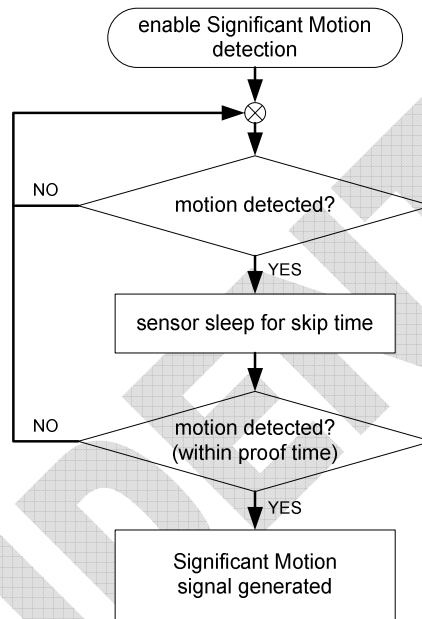

Significant Motion algorithm flow chart

10.4 Application Circuit

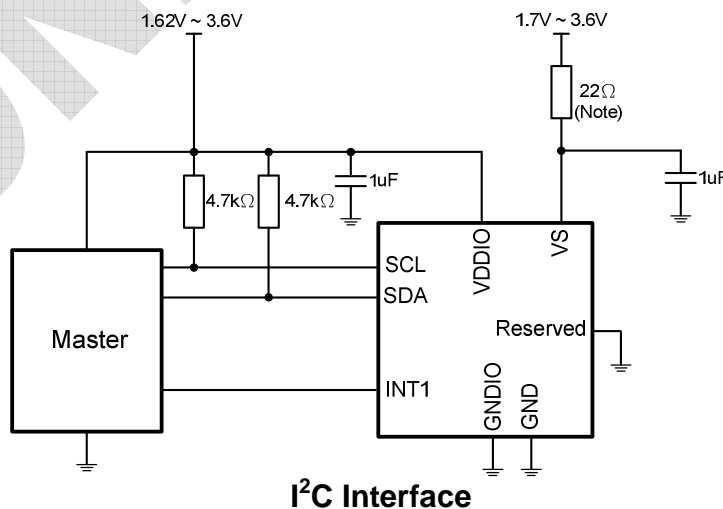

Note: A 22 ohm resistor is recommended to filter out the system power noise.

10.5 Sensing Axes Orientation

By measuring the acceleration components respect to g field, the position and orientation information could be recognized. It could be used for such applications as Portrait/Landscape in Mobile phone/PDA/PMP. This enables a product to set its display orientation appropriately to either portrait/landscape mode, or to turn off the display if the product is placed upside down. The sensor provides positive or negative directions of X/Y/Z axes. The relationship between directions and six different positions: Left, Right, Up, Down, Back, and Front, is shown in the following figure.



If the sensor is at rest and the force of gravity is acting along the indicated directions, the output of the corresponding channel will be negative (static acceleration).

Example: If the sensor is at rest or at uniform motion in a gravity field according to the figure given below, the output signals are:

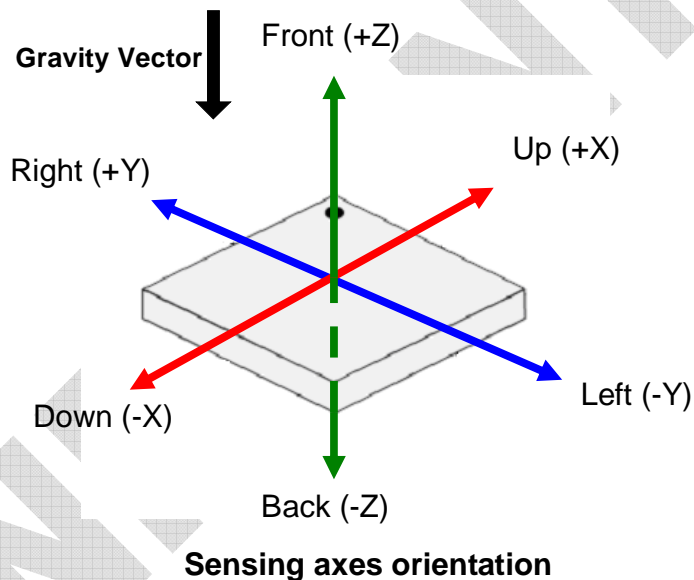
- ± 0g for the X-axis
- ± 0g for the Y-axis
- + 1g for the Z-axis

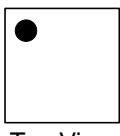
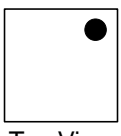
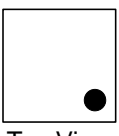
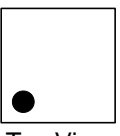

The following table lists all corresponding output signals on X, Y, and Z while the sensor is at rest or at uniform motion in a gravity field under assumption of a $\pm 2g$ range setting, a 12 bit resolution, and a top down gravity vector as shown above.

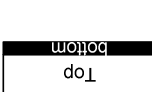
Sensor Orientation & Gravity Vector	Top View				Side View	Side View
						
X-axis Output	+1g/1024LSB	0g / 0 LSB	-1g/1024LSB	0g / 0 LSB	0g / 0 LSB	0g / 0 LSB
Y-axis Output	0g / 0 LSB	+1g/1024LSB	0g / 0 LSB	-1g/1024LSB	0g / 0 LSB	0g / 0 LSB
Z-axis Output	0g / 0 LSB	0g / 0 LSB	0g / 0 LSB	0g / 0 LSB	+1g/1024LSB	-1g/1024LSB

11. PACKAGE OUTLINE

11.1 Package Outline Drawing

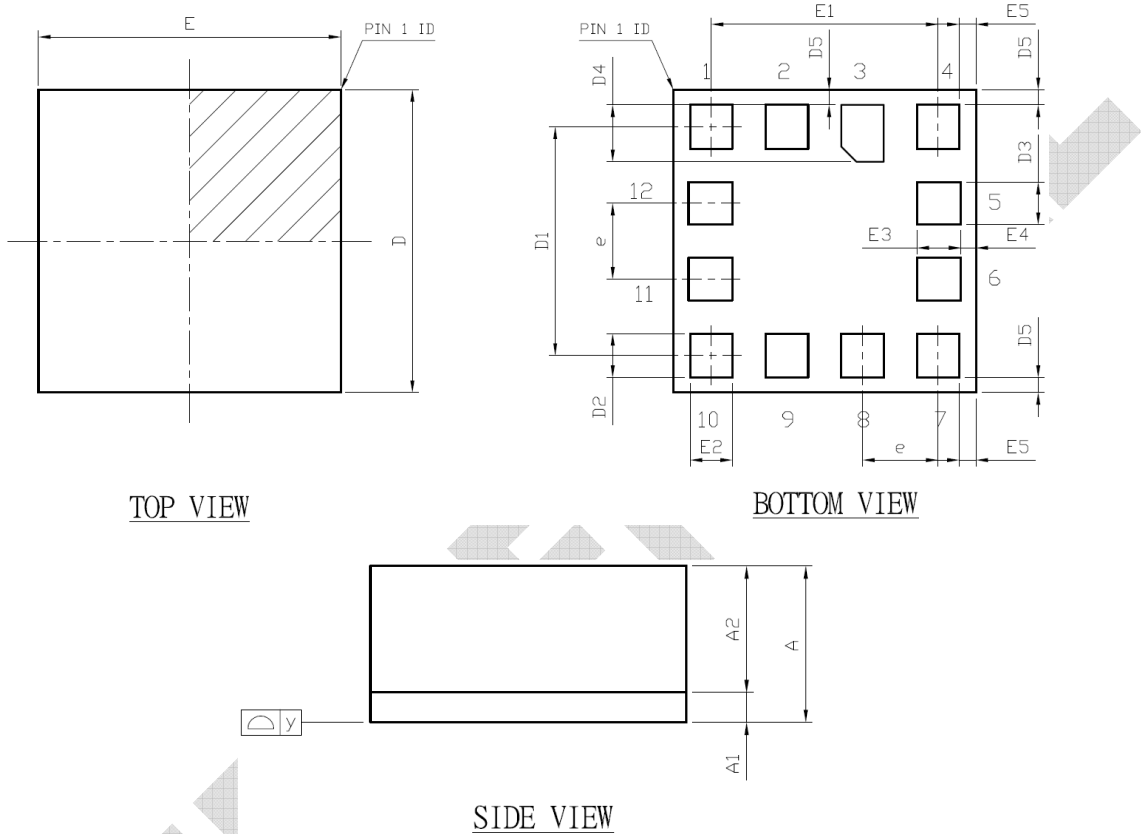

SYMBOLS	DIMENSIONS IN MILLIMETERS		
	MIN.	NOM.	MAX
A	0.95	1.00	1.05
A1	0.16	0.19	0.22
A2	0.80 REF.		
D	1.95	2.00	2.05
D1	1.51 REF.		
D2	0.24	0.29	0.34
D3	0.23	0.28	0.33
D4	0.325	0.375	0.425
D5	0.10 REF.		
E	1.95	2.00	2.05
E1	1.50 REF.		
E2	0.23	0.28	0.33
E3	0.24	0.29	0.34
E4	0.10 REF.		
E5	0.11 REF.		
e	0.50 REF.		
y	0.00	---	0.10

11.2 Recommended PCB Layout

The PCB layout should use NSMD (Non Solder mask Defined) pad definitions for all pads. The solder mask opening must be defined at least 0.05 mm larger than the metal pad on all sides.

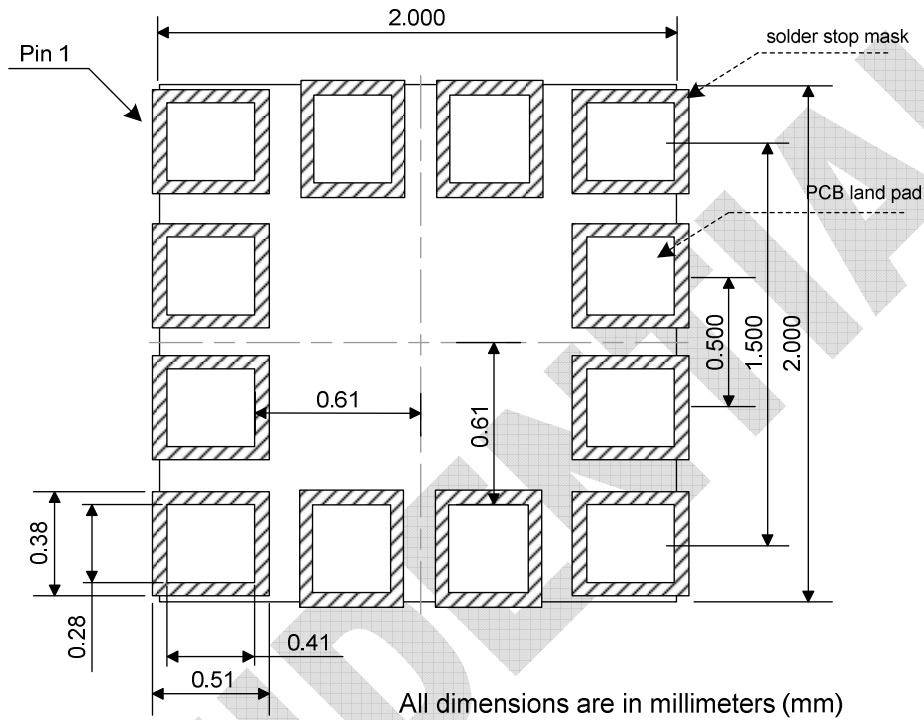

11.3 Marking Rule

Marking	Symbol	Name
<div style="border: 1px solid black; padding: 5px; display: inline-block;"> YYYY XXXX ● </div>	YYYY	Order number
	XXXX	Product serial number
	●	Pin1 dot

11.4 Tape and Reel Information

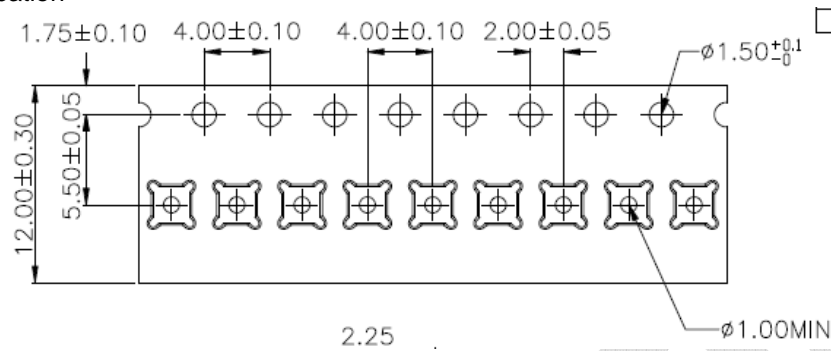

1. Carrier Tape Specification

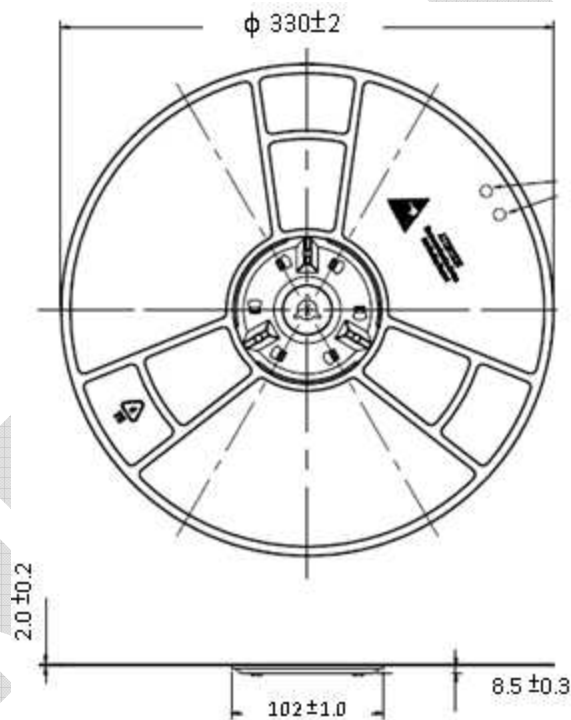

2. Reel Specification

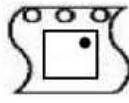

3. Unit Orientation

Process direction	
Orientation in carrier	
Orientation by quadrant	

11.5 Soldering Condition

1. Pb-free solder temperature profile

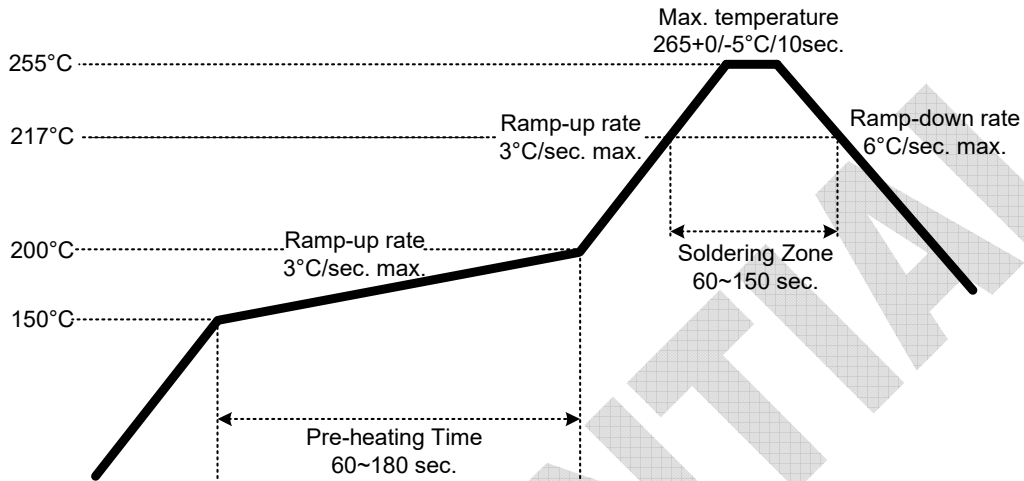

2. Reflow soldering should not be done more than three times.
3. When soldering, do not put stress on the ICs during heating.
4. After soldering, do not warp the circuit board.

11.6 Soldering Iron

Each terminal is to go to the tip of soldering iron temperature less than 350°C for 3 seconds within once in less than the soldering iron capacity 25W. Leave two seconds and more intervals, and do soldering of each terminal. Be careful because the damage of the product is often started at the time of the hand solder.

11.7 Repairing

Repair should not be done after the ICs have been soldered. When repairing is unavoidable, a double-head soldering iron should be used (as below figure). It should be confirmed beforehand whether the characteristics of the ICs will or will not be damaged by repairing.

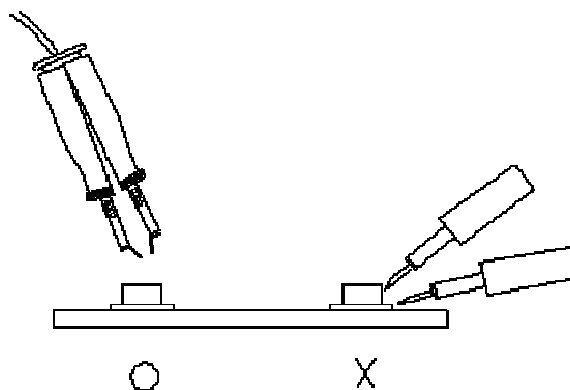

12. STORAGE INFORMATION

12.1 Storage Condition

1. Devices are packed in moisture barrier bags (MBB) to prevent the products from moisture absorption during transportation and storage. Each bag contains a desiccant.
2. The delivery product should be stored with the conditions shown below:

Storage Temperature	10 to 30°C
Relatively Humidity	below 60%RH

12.2 Treatment After Unsealed

1. Floor life (time between soldering and removing from MBB) must not exceed the time shown below:

Floor Life	168 Hours
Storage Temperature	10 to 30°C
Relatively Humidity	below 60%RH

2. When the floor life limits have been exceeded or the devices are not stored in dry conditions, they must be re-baked before reflow to prevent damage to the devices. The recommended conditions are shown below

Temperature	60°C
Re-Baking Time	12 Hours

Revision History

Date	Version	Modified Items
2019/11/26	1.0	Initial release.

Important Notice

This document contains information that is proprietary to Sensortek Technology Corp. (“sensortek”), and is subject to change without notice. Any part of this document may not be used, reproduced, duplicated or disclosed in any form or any means without the prior written permission of sensortek.

Sensortek does not warrant or represent that any license, either express or implied, is granted under any sensortek’s patent right, copyright, mask work right, or other intellectual property right relating to any combination, machine, or process in which sensortek’s products or services are used. In addition, Sensortek does not assume any liability for the occurrence of infringing on any patent or other intellectual property rights of a third party.

Sensortek reserves the right to make corrections, modifications, enhancements, improvements, and other changes to its products and services at any time and to discontinue any product or service without notice. Customers should obtain the latest relevant information before placing orders and should verify that such information is current and complete.