

STK33562

Ambient Light Sensor and Proximity Sensor

Design Guide

Version – 0.9

This document contains information that is proprietary to Sensortek Inc. (“sensortek”), and is subject to change without notice.

Any part of this document may not be used, reproduced, duplicated or disclosed in any form or any means without the prior written permission of sensortek.

Sensortek does not warrant or represent that any license, either express or implied, is granted under any sensortek ‘s patent right, copyright, mask work right, or other intellectual property right relating to any combination, machine, or process in which sensortek ‘s products or services are used. In addition, Sensortek does not assume any liability for the occurrence of infringing on any patent or other intellectual property rights of a third party.

Sensortek reserves the right to make corrections, modifications, enhancements, improvements, and other changes to its products and services at any time and to discontinue any product or service without notice. Customers should obtain the latest relevant information before placing orders and should verify that such information is current and complete.

Sensortek Technology Corporation

STK 33562 is an excellent ALS/PS sensor with ultra-high sensitivity, human eyes coating for ALS response (refer to CIE 1931 color matching functions) , over 100 degrees in ALS viewing angle, flexible PS photodiodes selection for applications, and well performance in signal to noise. With the popularity of full screen in mobile phones and portable devices, STK (Sensortek) provides solutions, Tiny-slit and Under-display, to reach out-standing and stable performance in applications. This document would detail recommended mechanical design for full screen devices.

Tiny-slit for Full Screen Mobile Phone

1. Mechanical Overview

A full screen mobile device does not allow a wide margin surrounding the screen for the high screen ratio. As the result, there is no space for the traditional ALS/PS sensor with one or two thoroughfare (Ink) on the cover glass. STK provides Tiny-slit tunnel solution, placing ALS/PS sensor at the tiny margin of the screen. This tiny slit tunnel comes from the frame of the device and the edge of display to become a 0.5-1.0mm width tunnel. ALS/PS sensor is placed under the display and emitting/receiving light through this tiny slit tunnel as Figure 1 shown.

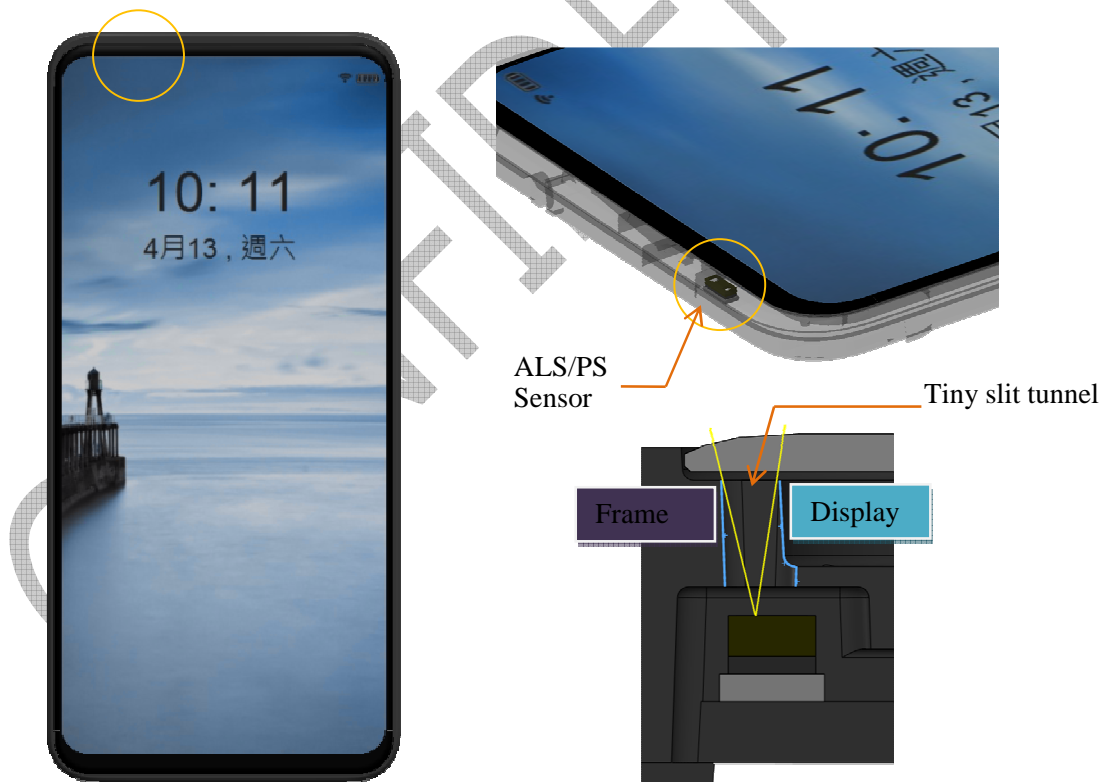

Figure 1 – Tiny slit for ALS/PS sensor placement

2. The Recommended TP2IC Range and Crosstalk Block Design

Considering the thickness of display, that dominates the distance (TP2IC) from sensor top surface to the bottom surface of cover glass. Normally, TP2IC is 1.0-1.5mm for OLED panel and 2.0-3.0mm for LCD panel. STK 33562 performs very well in tiny slit solution with ultra-high sensitivity; as a result, the internal crosstalk is quite easy induced. So the block crosstalk path is extremely important to see if succeed.

Display Panel	TP2IC (mm)	Crosstalk Block
OLED	1.0 – 1.5	Need
LCD	2.0 – 3.0	Need

There are two parts to block crosstalk path in tiny slit tunnel. The first one is blocker in the slit tunnel. As Figure 2, crosstalk comes from emitter emitting light and reflecting light by the tunnel surfaces to the sensor detection port. A blocker is placed between emitter port and detector port, and there would be a huge decrease of crosstalk. Blocker could be a rib of the frame.

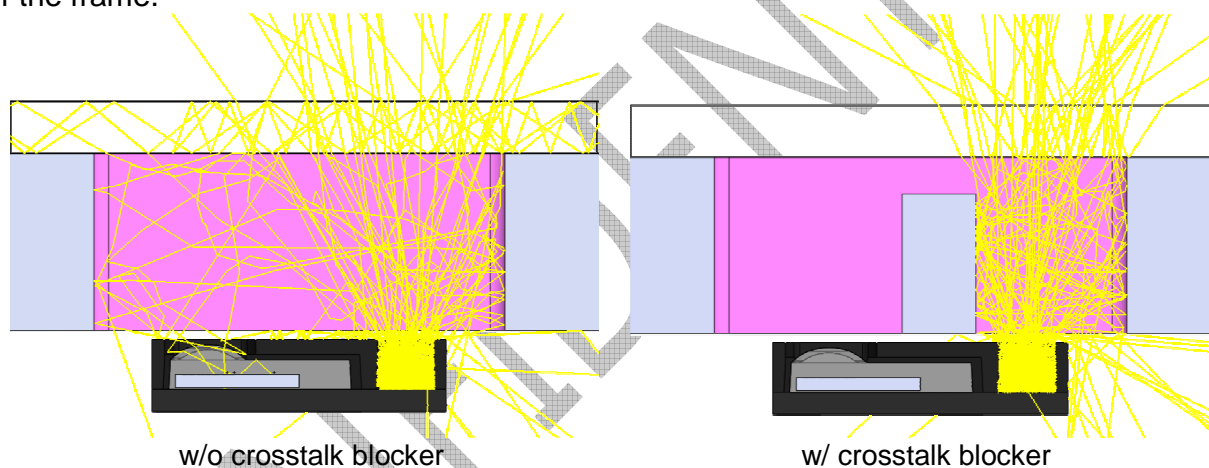

Figure 2 – Blocker in slit to block crosstalk

As we know, the slit tunnel is formed by frame and display, but blocker on frame is not allowed to contact the display in design. There should be a space for assembly tolerance. As Figure 3, try to make the blocker extending over the slit opening on the cover glass as you can. That would be much helpful for blocking crosstalk.

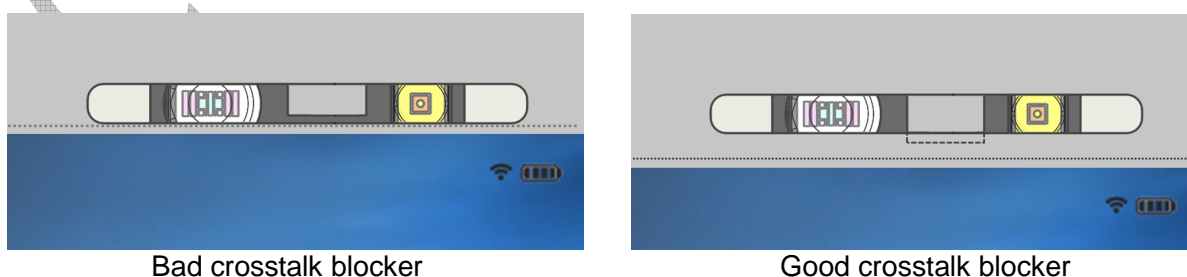

Figure 3 – Blocker in slit to block crosstalk

Here is a design condition of blocker for reference, Figure 4.

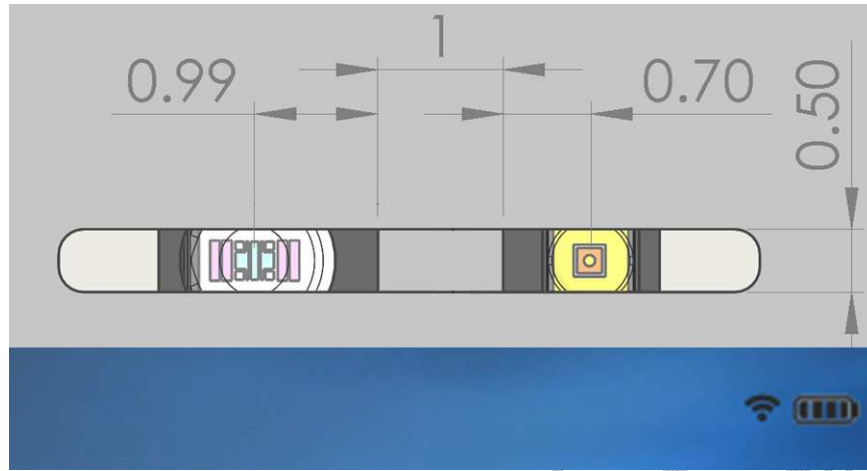

Figure 4 – Blocker condition for STK 33562

Items	Blocker width	Tiny slit width	Blocker to Emitter Center	Blocker to Detector Center
Design Value	1.0 mm	0.5 mm	0.7 mm	0.99 mm

Table 1 - Blocker condition for STK 33562

The 2nd part of crosstalk path is the spacing between sensor and display. As the same reason of assembly tolerance, there needs a space from sensor top surface and display bottom surface. And here is also an important path to contribute crosstalk. So blocking it is necessary. STK recommends a soft rubber to fully block the crosstalk through this path. Figure 5 shows the condition of rubber with emitter port and detector port opening.

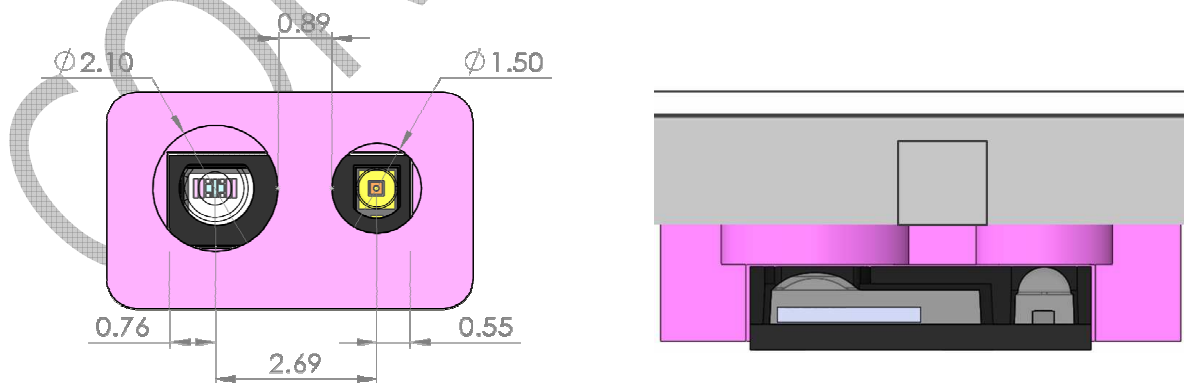

Figure 5 – Blocker condition for STK 33562

3. Ink condition for PS-only and ALS+PS

Ink is a coating or printing on the cover glass in order to hide the slit for appearance. STK recommend a black coating that transmittance > 10% (550nm), >80% (940nm) for PS-only. It is also listed as below table:

wavelength section (nm)	550	940
Transmittance requirement (%)	>10 ± 3%	> 85 ± 5%

Table 2 – Ink Transmittance for PS only

According to the tiny slit structure, normally ALS viewing angle is quite small in PS-only ink, 10~15 degree or so. In order to increase the FOV of ALS, STK provides a solution, placing a diffuser film below the cover glass or printing a diffusing ink on the bottom of cover glass. That would help diffusing light into tiny slit tunnel, no matter what kind of incident angle from outside. Diffusing layer is covering only detector port. This is very important. If diffusing layer covers over emitter port, that would cause extremely huge crosstalk. Figure 6 would illustrate the condition of diffusing area:

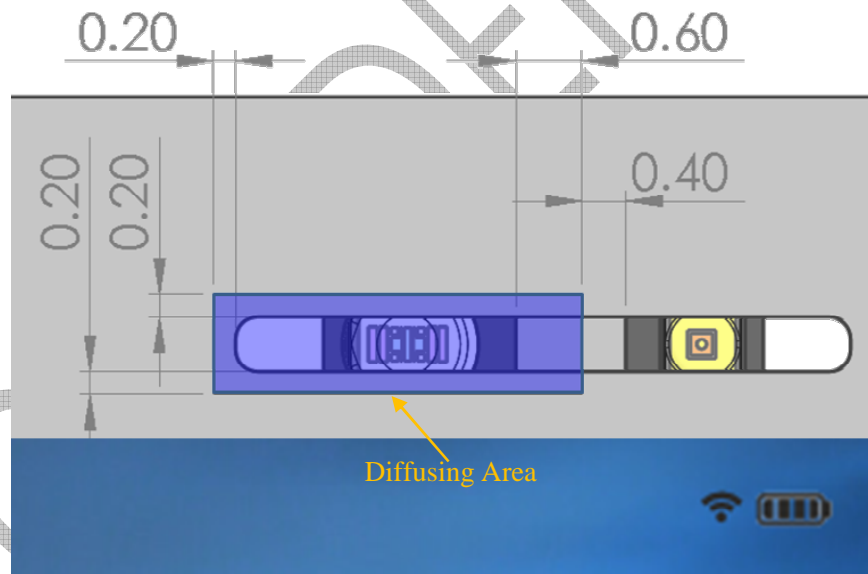
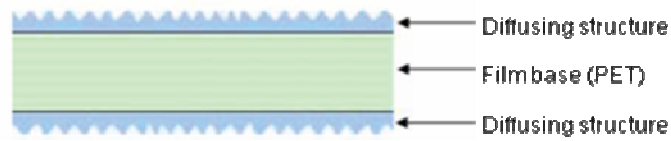

Figure 6 – Diffuser film / Diffusing coating area

Table 3, the diffuser film condition is illustrated as below.



Diffuser	Value
Diffuser Thickness	50 um
Diffuser Total Transmittance	45% - 55%
Haze (ASTM D1003)	> 95%

Table 3 – Ink Transmittance for PS only

Table 4, the diffusing ink condition is illustrated as below.

Diffusing Ink	Value
Diffuser ink layers	2 layers
Diffuser Total Transmittance	45% - 55%
Haze (ASTM D1003)	> 95%

Table 4 – Ink Transmittance for PS only

The more scattering level (Haze), the more wide ALS FOV, but the less sensitivity.

4. The key factors of wide ALS FOV in tiny slit

There is a misunderstanding that the deep scattering (diffusing) film (layers) helps wide ALS FOV. Basically it's correct, however if the scattering light from diffusing layers could not be reflected into detector, that helps nothing in ALS FOV. As the result, STK provides light guide solution for ALS+PS to guide light down to detector in tiny slit solution. But the light guide solution is not easy, it would spend lots of spacing and would not be easy for assembly.

If there just diffusing layer only without light guide, the inner reflective surface in tiny slit structure plays the key factor to guide the diffused light down to detector. As Figure 7, the higher reflectance of surface, the wider FOV of ALS is.

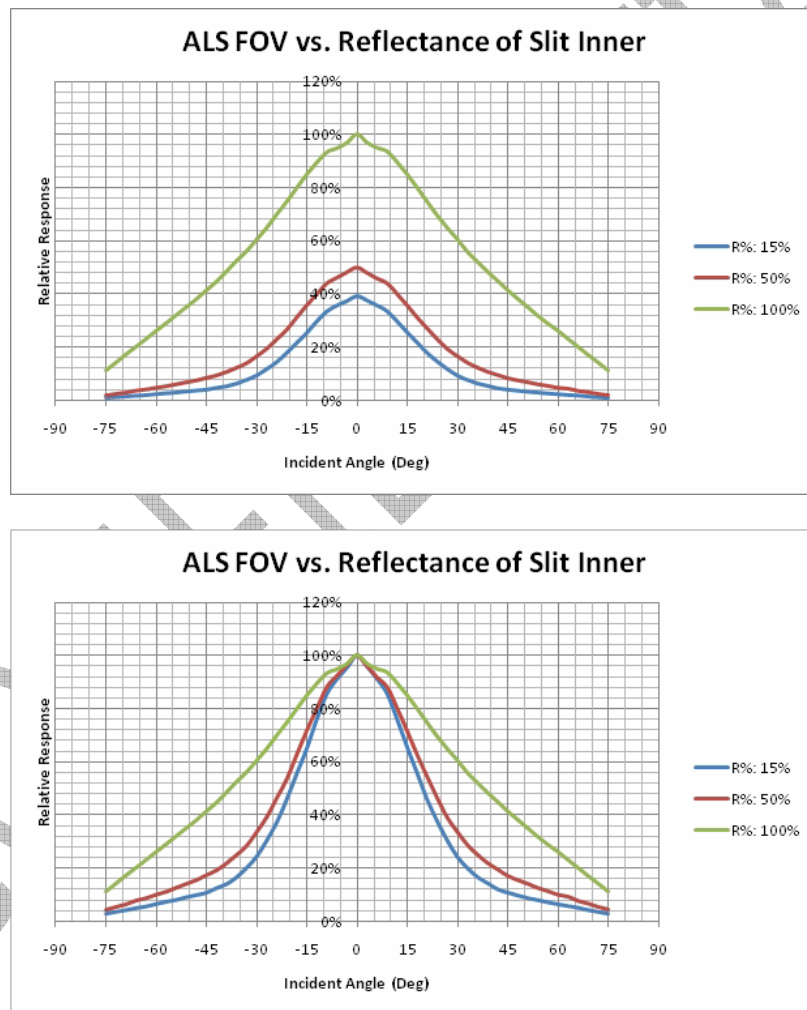

R% of Slit inner	15%	50%	100%
ALS FOV	± 19 Deg	± 22.5 Deg	± 37 Deg

Note: Specular 50%

Figure 7 – ALS FOV vs. Reflectance of Slit Inner

Specular reflection of inner slit surface is also a key factor for ALS FOV. The diffused light from diffusing layer should directly guide to detector, and that helps FOV and sensitivity. If the reflection of inner slit surface is lambertian, that causes 2nd, 3rd and more times diffusing and loses a lot of light. Figures 8 shows specular reflective inner surface helps ALS FOV wider.

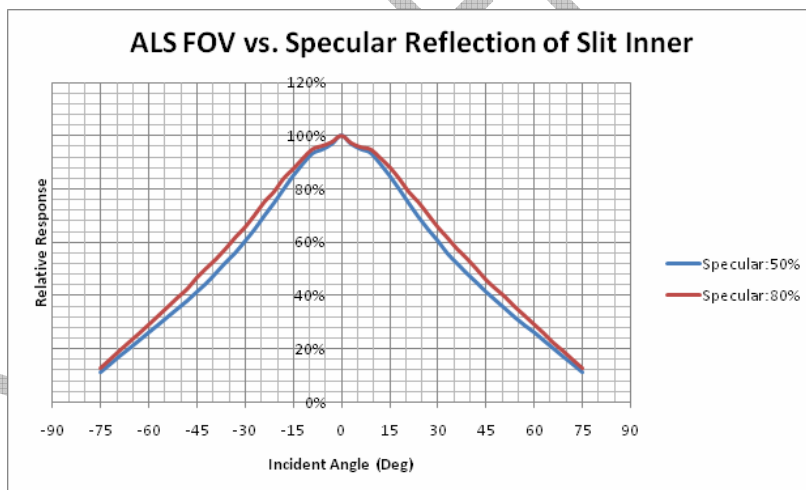
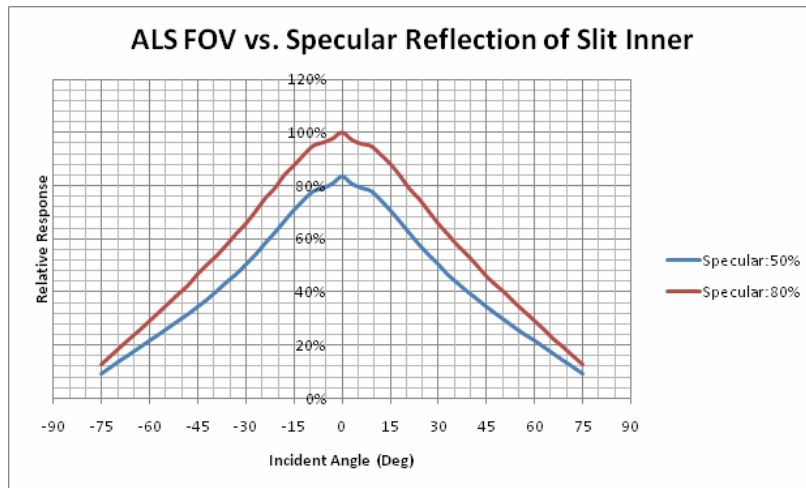

Specular of Slit inner	50%	100%
ALS FOV	± 37.8 Deg	± 42 Deg

Note: Reflectance 100%

Figure 8 – ALS FOV vs. Specular Reflection of Slit Inner

5. Example: Performance of ALS FOV & Proximity

Here illustrates an slit example and runs simulation to see the performance of STK 33562.

1. Slit width: 0.5 mm
2. Slit Length: 5.6 mm
3. Blocker width: 1.0 mm
4. Blocker to Emitter center: 0.7 mm
5. Emitter Opening of Rubber: ϕ 1.5 mm
6. Detector Opening of Rubber: ϕ 2.1 mm
7. Diffuser Area: As figure below
8. Reflectance of slit inner: 90%
9. Specular of slit inner: 80%
10. Cover glass thickness: 0.7 mm
11. Ink Transmittance: 7% in 550nm / 85% in 940nm
12. TP2IC: 2.5 mm – 3.0 mm

Slit and Blocker condition

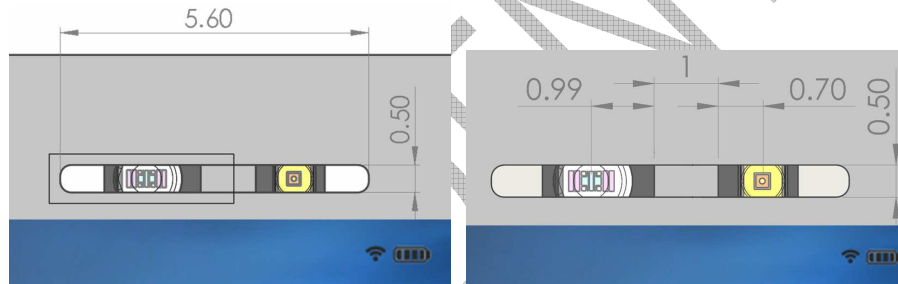

Rubber condition

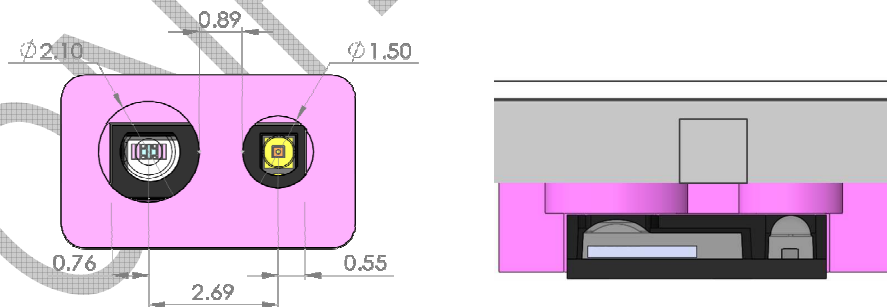

Diffusing condition

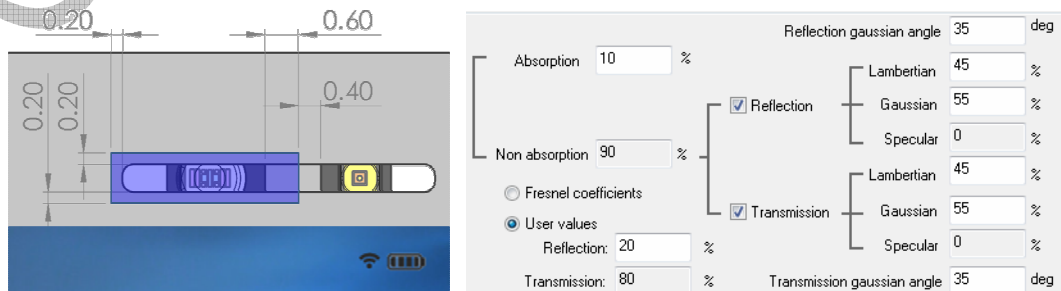

Sensortek Technology Corporation

[ALS FOV]

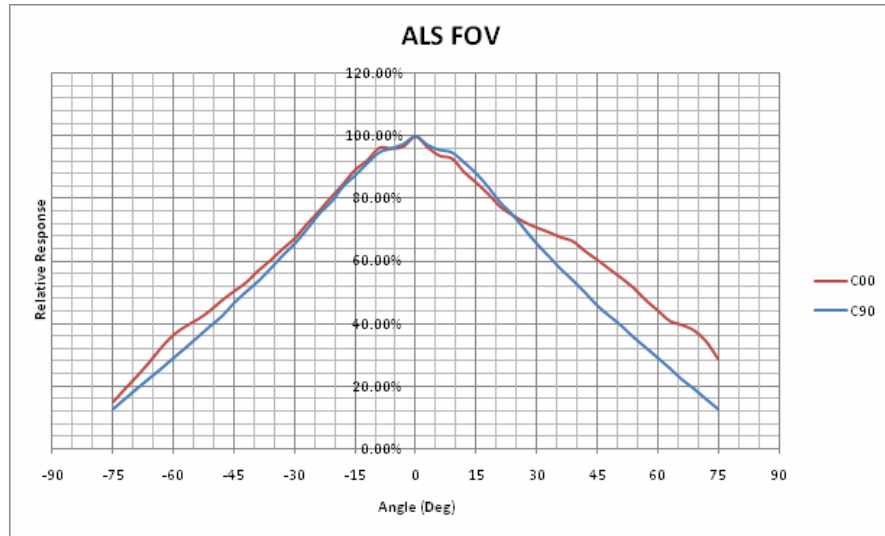

Unit: Deg

ALS FOV	C00	C90
Peak	0	0
FOV	100.9	84.2
Angle 1	52.3	40.1
Angle 2	-43.6	-40.2

[PS Performance]

TP2IC	2.50	2.75	3.00
CT	3458	3355	3288
W5	4402	4248	4133
W7	3940	3802	3699
W9	3750	3618	3521
W10	3694	3565	3469

* CT: crosstalk , W: Opteka white card, W5: white card at 5cm from TP top surface

TP2IC	2.50	2.75	3.00
CT	3458	3355	3288
B0	9162	8841	8602
G2	4361	4208	4095
G3	3860	3725	3624
G5	3603	3477	3383

* CT: crosstalk , B: Opteka Black card, G: Kodak Gray card, G5: Gary card at 5cm from TP top surface

Sensortek Technology Corporation

6. The Recommended PCB PAD Layout and Solder Mask Define

Suggested PCB pad layout and solder mask define guidelines for the Dual Flat No-Lead surface mount package are shown below.

STK33562 PCB PAD Layout

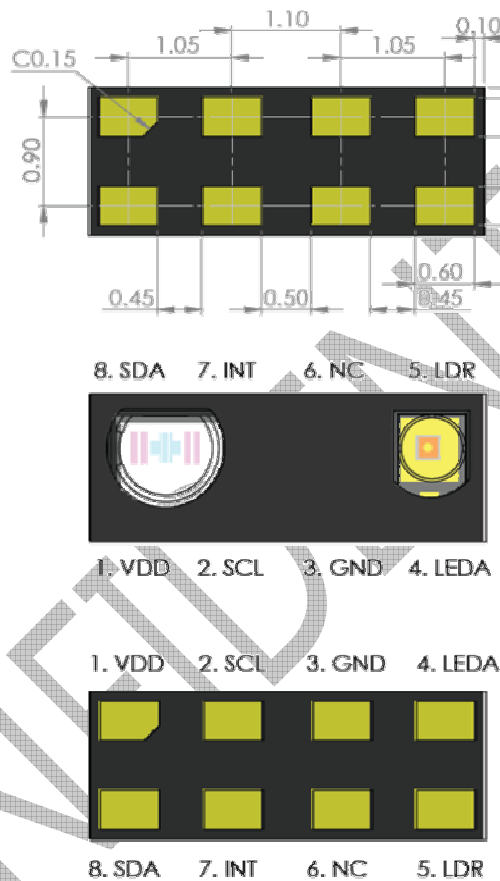

Solder Mask Define

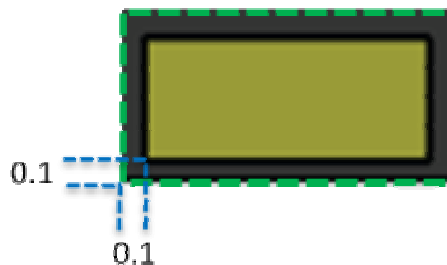

Notes: all linear dimensions are in mm.

Assembly tolerance is much concerned in tiny slit structure. STK 33562 emitting angle is ± 25 degree covering the slit shift tolerance in $\pm 0.10\text{mm}$ with slit width 0.50mm . If assembly tolerance is $>\pm 0.10\text{mm}$, the more wide slit width is needed. Slit shift tolerance $\pm 0.25\text{mm}$ with slit width $\geq 0.75\text{mm}$ is recommended. Also assembly tolerance causes sensitivity variation, so sensitivity calibration is highly recommended.

Note: if you cannot find the reference design from this document, please contact to sensortek FAEs for more information.

CONFIDENTIAL