



深圳市首韩科技有限公司

SHENZHEN SHOUHAN TECHNOLOGY CO.,LTD

Tel: 0755-27597601 Fax: 0755-27597491

承 认 书

SPECIFICATION FOR APPROVAL

客 户 Customer:

产品名称 Project:

Micro座

规格型号 Part No:

MICRO QTZB5.0 (040)

贵公司承认印 Approval signatures

料 号/Part No.	签 章/Signatures

日期 Date:

拟制/Drawn	李春风	
审核/Check	张栋	
批准/Approved	罗孝金	

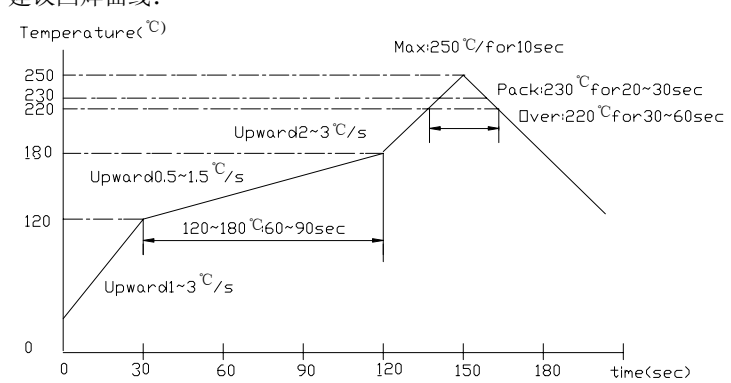
1. 物料明细:			
1.1. 塑胶部分: LCP UL94V-0			
1.2. 接触端子部分: C5191R-H, 镍底, 接触部位镀金 1μ”			
1.3. 外壳部分: C2680R-H, 外壳镀镍底 50μ”, 镀NI 80μ”			
2. 工作条件:			
2.1. 工作电流: 1Ampere			
2.2. 使用温度: -30℃~+80℃			
3. 电气性能部分			
序号	测试项目	规格和标准	测试方法及参考标准
			以低功率电流测试产品接触部位阻抗值
3.1	接触阻抗	30mΩ MAX	参考: EIA 364-23A
3.2	绝缘阻抗	100MΩ MIN 100V DC	测试相邻接触脚位之间塑胶阻抗值 参考: EIA 364-21A
3.3	耐压测试	100V AC 1 分钟 0.5mA	以 0.5mA 的电流测试接触脚位之间塑胶耐高压 1 分钟 参考: EIA 364-20A
4. 机械性能部分			
4.1	插入力	3.57kgf MAX	与线端匹配时, 线端以 25mm/分速度插入时的力 参考: EIA 364-13A
4.2	拔出力	1.00kgf MIN	与线端匹配时, 线端以 25mm/分速度拔出时的力 参考: EIA 364-13A
4.3	端子单 PIN 保持力	0.3 kgf MIN	接触 PIN 以 25mm/分速度从塑胶中退出来的力
4.4	寿命测试	1. 产品外观无明显损伤 2. 插入力: 3.57kgf MAX 拔出力: 0.81~2.05 kgf	以每小时 600 次匀速插拔产品 3000 次 参考: EIA 364-09A
4.5	振动测试	10 ⁻⁶ 秒	以每分钟频率由 10HZ 至 55HZ, 再回到 10HZ 为一循环, 连续测试 X/Y/Z 三个方向各 2 小时。 振幅为 1.5mm 参考: EIA 364-28A
5. 环境性能部分			
5.1	沾锡性	吃锡面积达 95%以上	产品焊接区于温度为 235±5℃锡炉中浸泡 5±0.5 秒 参考: MIL STD-202F
5.2	耐高温	1. 外观无明显损伤 2. 接触阻抗 100mΩ MAX 3. 绝缘阻抗 100MΩ MIN	将产品置于 85℃的高温炉中 96 小时后, 再于常温中置放 3 小时后观察。 参考: MIL STD-1344A
5.3	低温性	1. 外观无明显损伤 2. 接触阻抗 100mΩ MAX 3. 绝缘阻抗 100MΩ MIN	将产品置于-40℃的低温炉中 96 小时后, 再于常温中置放 3 小时后观察。 参考: MIL STD-1344A
5.4	耐湿性	1. 外观无明显损伤 2. 接触阻抗 100mΩ MAX 3. 绝缘阻抗 100MΩ MIN	将产品置于温度为 40±2℃, 湿度为 90~95RH 环境中, 120 小时后观察。 参考: EIA 364-31A
5.5	耐腐蚀性	1. 外观无明显腐蚀 2. 接触阻抗 50mΩ MAX	将产品置放于盐水浓度为 5%, 温度 35±2℃的盐雾箱中连续喷雾 12 小时, 于常温放置 1 小时后观察产品。 参考: EIA 364-26A
5.6	耐焊接性	1. 外观无明显变色、起泡; 2. 焊脚吃锡平滑	建议回焊曲线:  <p>The graph shows a reflow soldering temperature profile. The y-axis is Temperature (°C) from 0 to 250. The x-axis is time (sec) from 0 to 180. The profile starts at 0°C, rises at 1~3°C/s to 120°C, stays at 120°C for 60~90 seconds, then rises at 0.5~1.5°C/s to 180°C, stays at 180°C for 60~90 seconds, then rises at 2~3°C/s to a peak of 250°C for 10 seconds, then falls at 2~3°C/s to 220°C, stays at 220°C for 30~60 seconds, and finally falls to 230°C for 20~30 seconds.</p>

ROHS

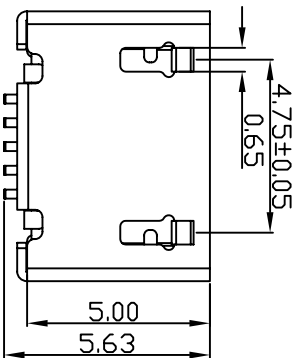
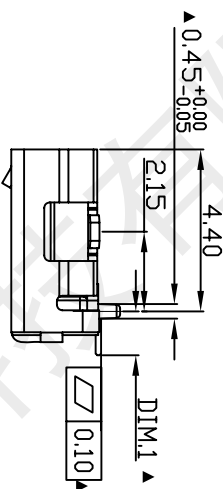
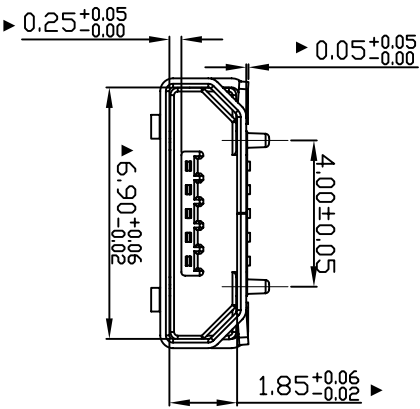
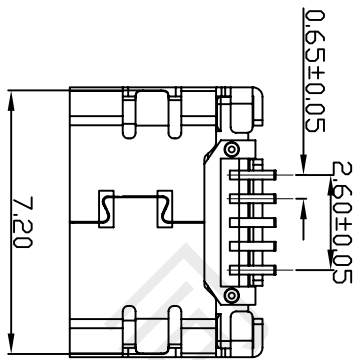

- Specification:
1. Electrical Characteristics:
 - Current rating: 1,5PIN 1.8A Max/2,3,4PIN 1A Max.
 - Dielectric withstanding voltage: 100 V(ac) for 1 min.
 - Insulation Resistance: 100 MΩ Minimum.
 - Contact Resistance: 30 mΩ Maximum.
 2. Environmental:
 - Operating Temperature: -30°C~+80°C.
 3. Mechanical Characteristics:
 - Total mating force: 3.57 Kgf Max.
 - Total unmating force: 1.0 Kgf Min.
 4. Material:
 - Insulator: HI-Temp Plastic UL 94V-0 Rated.
 - Contact: Copper Alloy(t=0.15mm).
 - Shell: Copper Alloy(t=0.20mm)/spcc 双光(t=0.25mm).

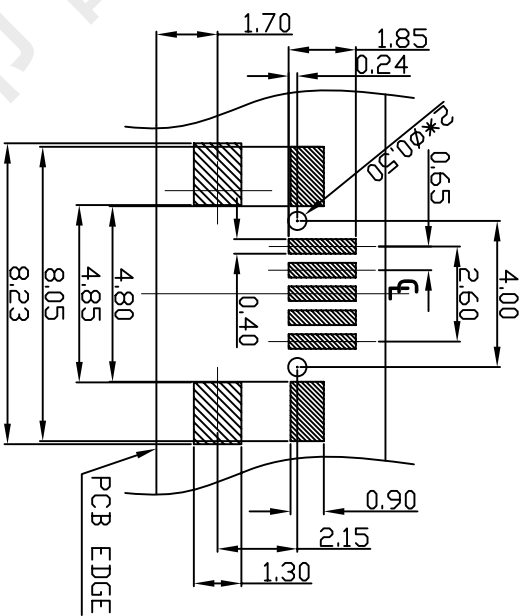
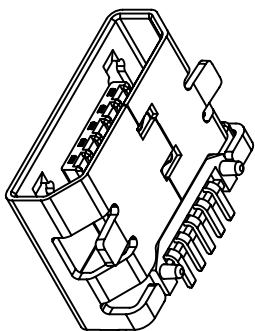

RECOMMENDED P.C.B. LAYOUT
TOLERANCE UNSPECIFIED ±0.05mm

DIM.1	A	1.20
	B	1.00
	C	0.80

-TOLERANCES-
UNLESS OTHERWISE SPECIFIED
公差参考表

X.	±0.20	X.XXX	±0.020
XX	±0.15	XX°	±5.00°
XXX	±0.10	XXX°	±2.00°



TITLE: **MICRO**



深圳市首韩科技有限公司

DATE	DR.BY	ECN.NO.	DESCRIPTION	MARK	VER.	X.XX	±0.10	X.XX°	±2.00°	DR.AW: 罗孝金	2017.10.17	1:1	mm	CD	1/1
					B/0	X.	±0.20	X.XXX	±0.020	APPD: 李春风	PRODUCT NO: MICRO QTZB5.0 (040)	SCALE	UNIT	TYPE	PAGE
						XX	±0.15	XX°	±5.00°	CHECK: 张栋	DATE	SCALE	UNIT	TYPE	PAGE
						XXX	±0.10	XXX°	±2.00°	DRAW: 罗孝金	DATE	SCALE	UNIT	TYPE	PAGE