

产 品 规 格 书

SPECIFICATIONS FOR PRODUCT

产品类型 TYPE : Crystal Oscillator

产品规格 SPEC : 50MHz/5032/3.3V

产品型号 P/N : CJO04-500003320B30

日期 DATE : 2019/07/05

核准及签名			部门
R&D APPR. SIGNATURED			DEPT.
拟制	审核	批准	频率器件事业部
ISSUE	CHECK	APPROVAL	
魏永鑫 2019/07/05	许秋菊 2019/07/05	杨立新 2019/07/05	

江 苏 长 晶 科 技 有 限 公 司

JIANGSU CHANGJING ELECTRONICS TECHNOLOGY CO., LTD

地址：中国江苏省南京江北新区产业技术研创园江淼路88号腾飞大厦C座13楼

Add: 13Th Floor, C Block, Tengfei Building, No. 88 Jiangmiao Rd. Pukou

District, Nanjing City, Jiangsu Province, China

**SMD5.0 * 3.2 Crystal Oscillator****CJO04-500003320B30**

1. Scope:
 - 1.1 This specification applies to the RoHS crystal oscillator with a frequency of 50MHz which will be used in electronic equipment.
2. Construction:
 - 2.1 Oscillators series: SMD 5.0×3.2 XO
 - 2.2 Package: SMD 5.0×3.2
3. Electrical Characteristics
 - 3.1 Nominal Frequency: 50MHz
 - 3.2 Frequency Stability: ±20 ppm
(incl. 25°C tolerance)
 - 3.3 Aging: ±3ppm/year
 - 3.4 Operating Temperature Range: -40°C to +85°C
 - 3.5 Storage Temperature Range: -55°C to +125°C
 - 3.6 Input Voltage (V_{DD}): +3.3Vdc±10%
 - 3.7 Input Current (I_{DD}): 20mA max
 - 3.8 Output Waveform: CMOS
 - 3.9 Output Symmetry: 50±10%
 - 3.10 Rise/Fall Time: 8ns max
 - 3.11 Output Voltage V_{OL} : 10%VDD
 V_{OH} : 90%VDD
 - 3.12 Output Load: 15pF
 - 3.13 Output State Control: Enable/disable
 - 3.14 Start-up Time: 5ms max
 - 3.15 Standby current: 10µA max
 - 3.16 Phase Jitter (rms): 1ps rms max 12kHz to 20MHz max
 - 3.17 Oscillation mode: Fundamental
 - 3.18 Others: Not recommended for safety applications

4. Reliability Specifications

This is the quality control and quality assurance and reliability tests performance data for the RoHS 50MHz SMD 5.0×3.2 XO related to the specification and approval sheet provided by JSCJ .

Standard test condition (TEMP.: 20±15°C. Relative humidity: 65±20%)

For any discrepancy in GO/NG, test will be done at TEMP.25±2°C. R.H. 65±5%.

NO.	ITEM	SPECIFICATION	TEST METHOD
4.1	Temperature Cycle (GB/T 2423.22-2002, Method Nb)	Frequency change after test≤±5ppm.	10 cycles from -55°C to 125°C. Measurement taken after DUT being left at room temperature for 24±2 hours.
4.2	Low Temperature Storage (GB/T 2423.1-2001, Method Aa)	Frequency change after test≤±5ppm.	Spending 72 hrs at -55°C±3°C constant temperature. Measurement taken after DUT being left at room temperature for 24±2 hours.
4.3	High Temperature Storage (GB/T 2423.2-2001, Method Ba)	Frequency change after test≤±5ppm.	Spending 72 hrs at 125°C±3°C constant temperature. Measurement taken after DUT being left at room temperature for 24±2 hours.
4.4	Humidity (GB/T 2423.3-2006, Method Cab)	Frequency change after test≤±5ppm.	Spending 96 hrs at 40 °C ± 3 °C, with 90± 3% R.H. Measurement taken after DUT being left at room temperature for 24±2 hours.
4.5	Vibration (GB/T 2423.10-1995, Method Fc)	Frequency change after test≤±5ppm.	Apply 0.75mm vibration at sweep frequency 10~500 Hz, for 2h. 10 cycles in each direction of 3 axis. Measurement taken after 1 hour.
4.6	Shock (GB/T 2423.5-1995, Method Ea)	Frequency change after test≤±5ppm. No visible damages.	Peak 1000m/s ² , normal width 6ms half sine wave form, 3.7m/s, 3 perpendicular axis of samples, 3 cycles / direction, total 18 cycles. Measurement taken after 1 hour.
4.7	Drop (GB/T 2423.8-1995, Method Ed)	Frequency change after test≤±5ppm. No visible damages.	Free drop to the wooden plate from 1.0 m heights for 3 times.
4.8	Solderability (GB/T 2423.28-2005, Method Tc)	Terminals shall be covered more then 95% with solder.	In 255 ± 5°C solder bath for 2 ± 0.5 seconds. There is no need to do functioned test. 8-12X magnifier.
4.9	Terminal Strength (JIS-C-6429 Method 1 & 2)	No visible damage	Mount on a glass-epoxy board (100x50x1.6mm), then bend to 2mm displacement (velocity 1mm/sec) and keep for 5 seconds. or pulling force 0.5 kg for at least 60 seconds.
4.10	Resistance to Soldering Heat (GB/T 2423.28-2005, Test Tb Method 1B)	Frequency change after test≤±5ppm.	Passed through the re-flow oven under the following condition. Preheat to 150°C±5°C for 60 to 120sec, and peak 265°C±5°C for 10s±3sec. Measurement taken after DUT being left at room temperature for at 24±2 hours.
4.11	OTHERS		

5. Recommended Reflow soldering condition (SMD)

■ Solder profile

Peak: $260 \pm 5^\circ\text{C}$ Soldering zone: 230°C or more, $30 \pm 10\text{s}$.

Pre-heating zone 1: $150 \sim 180^\circ\text{C}$, $90 \pm 30\text{s}$

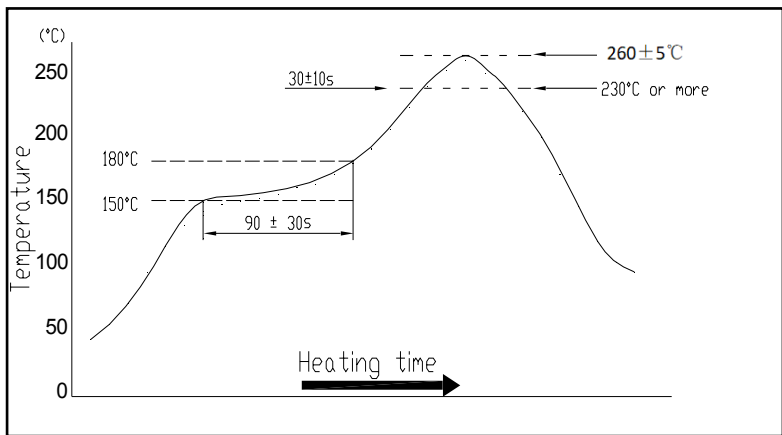

Temperature profile for reflow soldering

6. Soldering iron method

Bit temperature: $350 \pm 10^\circ\text{C}$ Application time of soldering iron: $3+1\text{ s}$

For other procedures, refer to IEC 60068-2-20.

PIN CONNECTION

P/N	CJO04
1	Enable/Disable *
2	GND
3	Output
4	VDD

* Enable/Disable functional description

When pin1 goes high ($>=0.7V_{DD}$) or open ,the Oscillator in normal operation and has output in frequency. When pin1 goes low ($<=0.3V_{DD}$) ,the oscillator stops and the oscillator output (Pin3) becomes high impedance.

CMOS TEST CIRCUIT

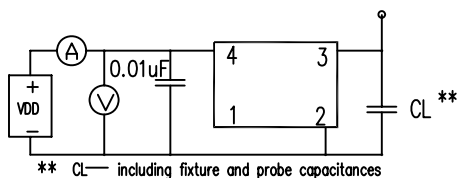

TYPICAL CMOS WAVE FORM

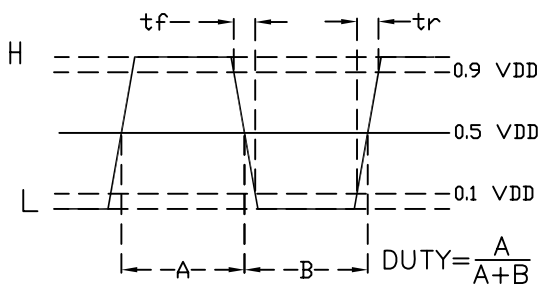

TTL TEST CIRCUIT

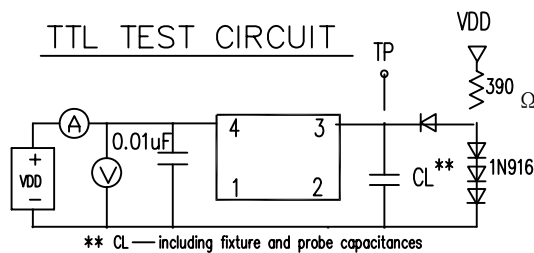

TYPICAL TTL WAVE FORM

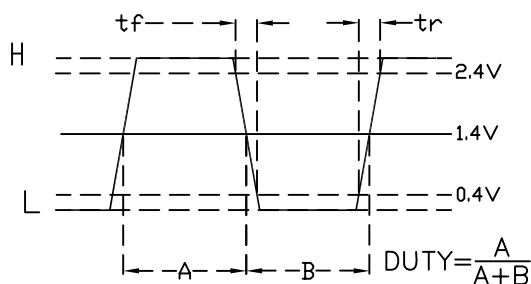

Package Outline Dimensions

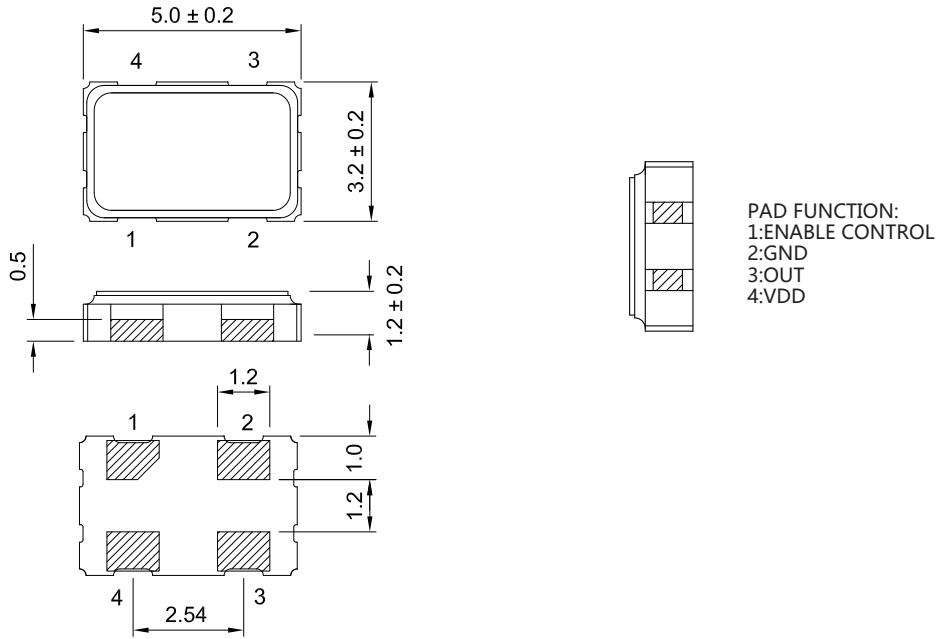

Suggested Pad Layout

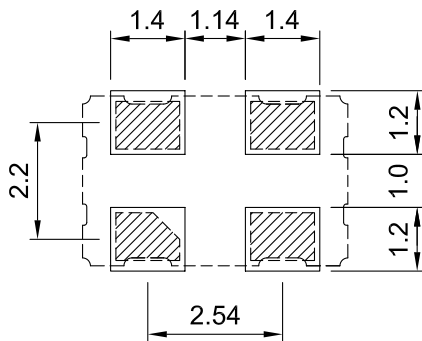

NOTICE

JSCJ reserve the right to make modifications, enhancements, improvements, corrections or other changes without further notice to any product herein. JSCJ does not assume any liability arising out of the application or use of any product described herein.

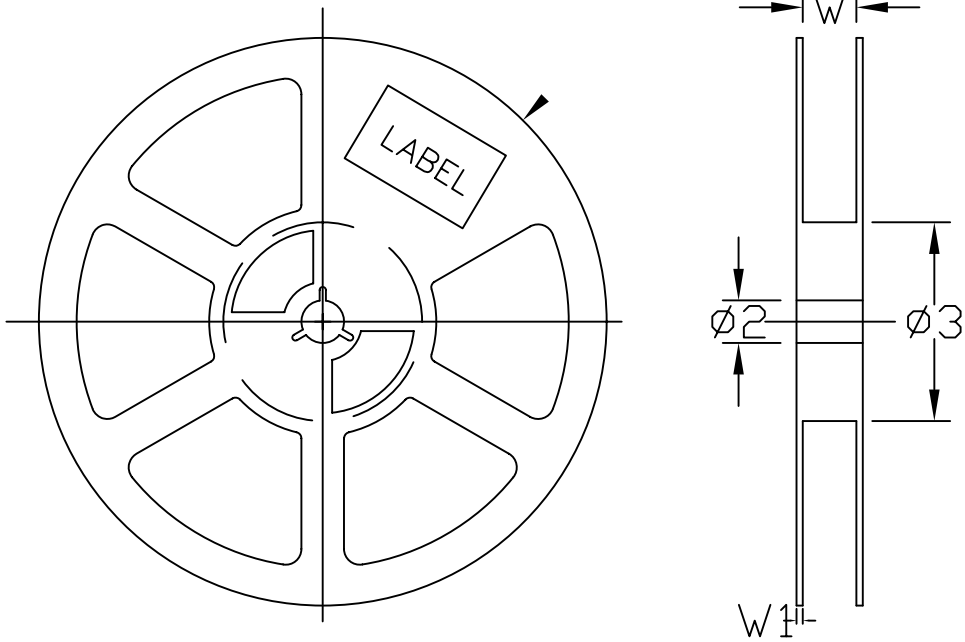

REEL DIMENSIONS

ITEM	$\phi 1 \pm 0.5$	$\phi 2 \pm 0.25$	$\phi 3 \pm 0.3$	$W \pm 0.2$	$W1 \pm 0.25$
16mm	178	13.2	62.5	16.4	2

LABEL: JSCJ P/N: xxx...xxx
 Freq: ff.fff
 Qty: 1000Pcs

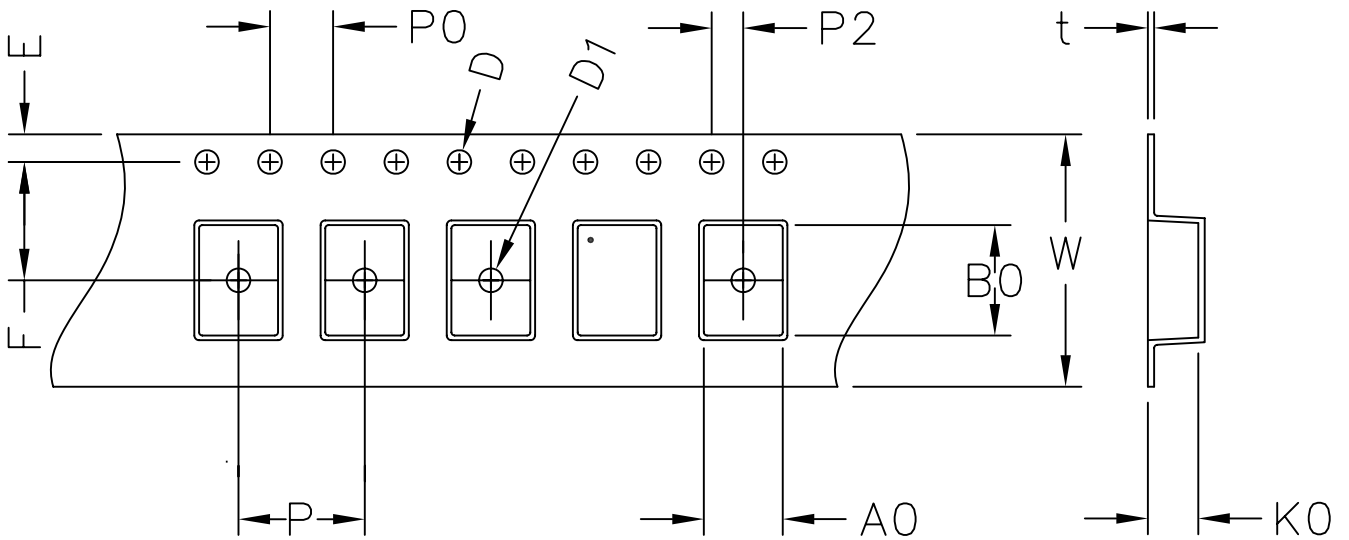

EMBOSSED TYPE DIMENSIONS

ITEM	$W + 0.3/0.1$	$A0 \pm 0.1$	$B0 \pm 0.1$	$K0 \pm 0.1$	$P \pm 0.1$	$F \pm 0.1$	$t \pm 0.05$	Qty
149	16.0	3.2	5.0	2.0	8.0	7.5	0.3	1000

$E = 1.75 \pm 0.1$, $D = 1.5 \pm 0.1$, $D1 = 1.5 + 0.25 / -0.0$, $P0 = 4.0 \pm 0.1$, $P2 = 2.0 \pm 0.1$