

### FEATURES

- NPN epitaxial silicon, planar design.
- Collector-emitter voltage  $V_{CE}=300V$ .
- Collector current  $I_C=0.3A$ .
- Transition frequency  $f_T > 50MHz$  @  $I_C=10mA_{dc}$ ,  $V_{CE}=20V_{dc}$ ,  $f=30MHz$ .
- In compliance with ER RoHS 2002/95/EC directives.



### MECHANICAL DATA

Case: SOT-23, Plastic  
 Terminals: Solderable per MIL-STD-750, method 2026  
 Approx. Weight: 0.008gram  
 Marking: 1D

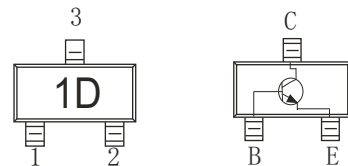

### MAXIMUM RATINGS ( $T_a=25^{\circ}C$ unless otherwise noted)

| Symbol          | Parameter                                   | Vaule    | Unit          |
|-----------------|---|----------|---------------|
| $V_{CBO}$       | Collector-Base Voltage                      | 300      | V             |
| $V_{CEO}$       | Collector-Emitter Voltage                   | 300      | V             |
| $V_{EBO}$       | Emitter-Base Voltage                        | 5        | V             |
| $I_C$           | Collector Current                           | 0.3      | A             |
| $P_D$           | Total Device Dissipation                    | 0.3      | W             |
| $R_{\theta JA}$ | Thermal Resistance Form Junction to Ambient | 416      | $^{\circ}C/W$ |
| $T_J$           | Junction Temperature                        | 150      | $^{\circ}C$   |
| $T_{STG}$       | Storage Temperature                         | -55~+150 | $^{\circ}C$   |

# MMBTA42

## ELECTRICAL CHARACTERISTICS (Ta=25°C unless otherwise specified)

| Parameter                            | Symbol        | Test Condition                                  | Min. | Typ. | Max. | Units   |
|--------------------------------------|---------------|---|------|------|------|---------|
| Collector-Base breakdown voltage     | $V_{(BR)CBO}$ | $I_C=100\mu A, I_E=0$                           | 300  |      |      | V       |
| Collector-Emitter breakdown voltage  | $V_{(BR)CEO}$ | $I_C=1mA, I_B=0$                                | 300  |      |      | V       |
| Emitter-Base breakdown voltage       | $V_{(BR)EBO}$ | $I_E=100\mu A, I_C=0$                           | 5    |      |      | V       |
| Collector cut-off current            | $I_{CBO}$     | $V_{CB}=200V, I_C=0$                            |      |      | 0.25 | $\mu A$ |
| Collector cut-off current            | $I_{CEX}$     | $V_{CE}=200V, I_B=0$                            |      |      | 0.25 | $\mu A$ |
| Base cut-off current                 | $I_{BEX}$     |   |      |      | 0.25 | $\mu A$ |
| Emitter cut-off current              | $I_{EBO}$     | $V_{EB}=4V, I_C=0$                              |      |      | 0.25 | $\mu A$ |
| DC current gain*                     | $H_{FE}$      | $I_C=1mA, V_{CE}=10V$                           | 10   |      |      |         |
|                                      | $H_{FE}$      | $I_C=0.1mA, V_{CE}=10V$                         | 40   |      |      |         |
|                                      | $H_{FE}$      | $I_C=10mA, V_{CE}=10V$                          | 100  |      | 200  |         |
|                                      | $H_{FE}$      | $I_C=50mA, V_{CE}=10V$                          | 40   |      |      |         |
|                                      | $H_{FE}$      | $I_C=20mA, V_{CE}=10V$                          | 30   |      |      |         |
| Collector-Emitter saturation voltage | $V_{CE(SAT)}$ | $I_C=20mA, I_B=2mA$                             |      |      | 0.2  | V       |
|                                      |               | $I_C=200mA, I_B=20mA$                           |      |      | 1    | V       |
| Base-Emitter Saturation voltage*     | $V_{BE(SAT)}$ | $I_C=20mA, I_B=2mA$                             |      |      | 0.9  | V       |
|                                      |               | $I_C=200mA, I_B=20mA$                           |      |      | 2    | V       |
| Input capacitance                    | $C_{IB}$      | $V_{CB}=6V, I_E=0, f=1MHz$                      |      |      | 4.0  | pF      |
| Output capacitance                   | $C_{OB}$      | $V_{EB}=0.5V, I_C=0, f=1MHz$                    |      |      | 8.0  | pF      |
| Transition frequency                 | $f_T$         | $I_C=10mA, V_{CE}=20V, f=30MHz$                 | 50   |      |      | MHz     |
| Delay time                           | $t_d$         | $V_{CC}=30V, V_{BE}=-0.5V, I_C=150mA, I_B=15mA$ |      |      | 35   | nS      |
| Rise time                            | $t_r$         |   |      |      | 35   | nS      |
| Storage time                         | $t_s$         | $V_{CC}=30V, V_{BE}=-0.5V, I_{B1}=I_{B2}=15mA$  |      |      | 200  | nS      |
| Fall time                            | $t_f$         |   |      |      | 50   | nS      |

\*Pulse Test: Pulse Width<300uS, Duty Cycle<2.0%.

# MMBTA42

## ELECTRICAL CHARACTERISTICS ( $T_a=25^\circ\text{C}$ unless otherwise specified)

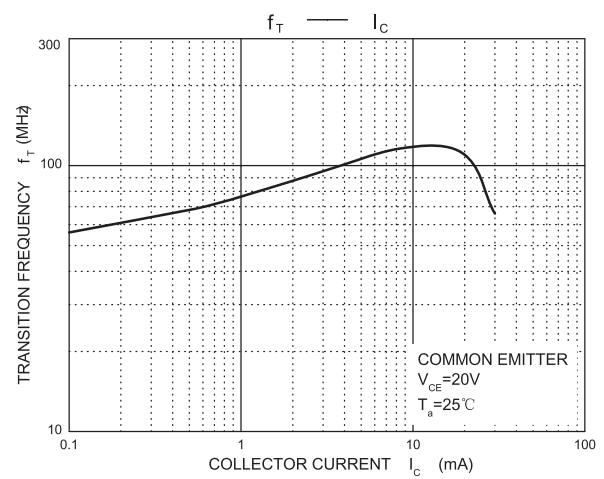
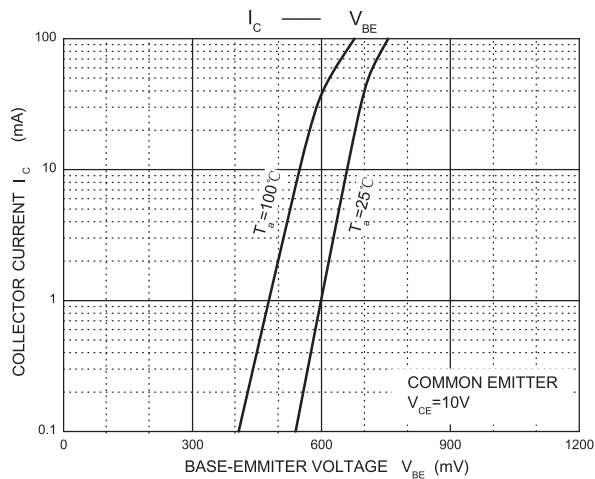
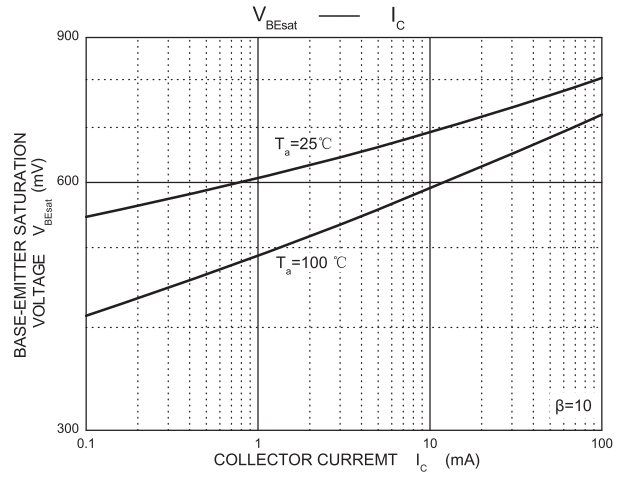
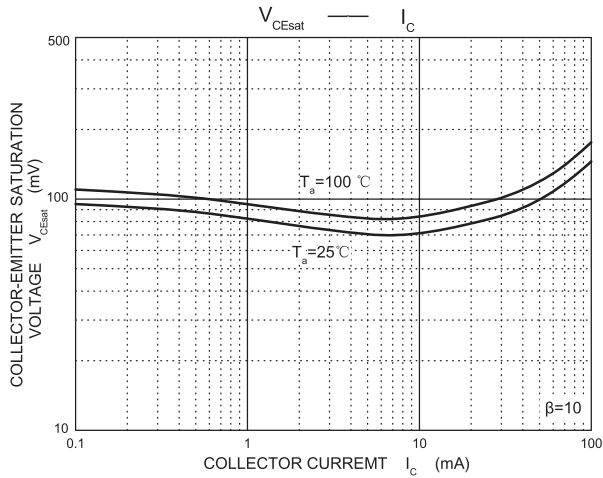
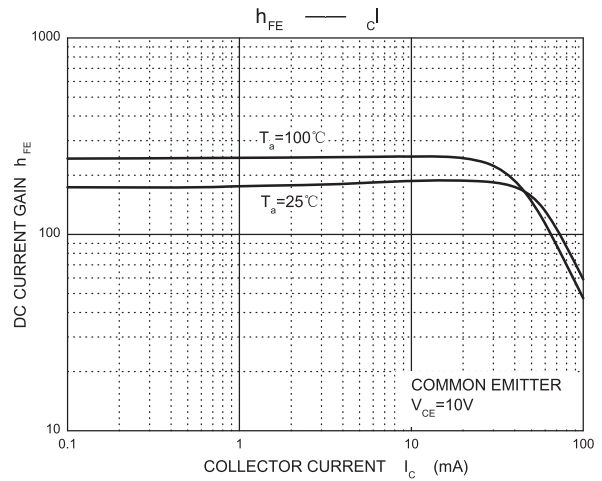
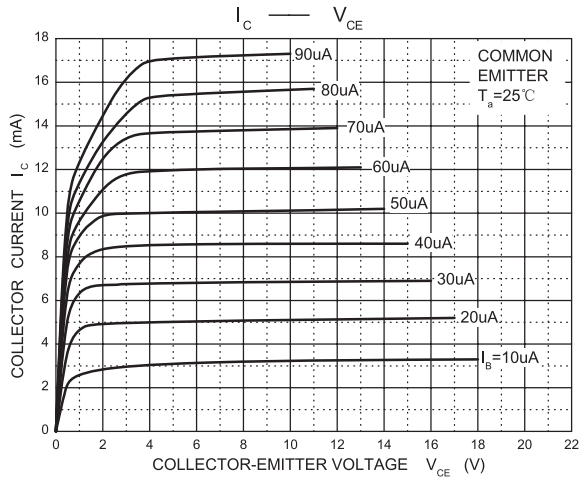

# MMBTA42

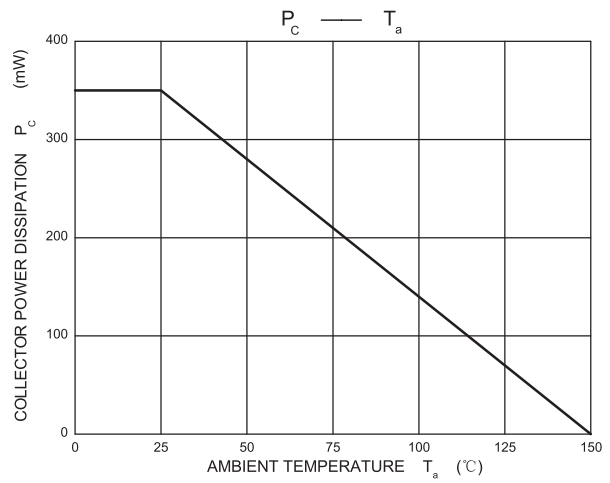
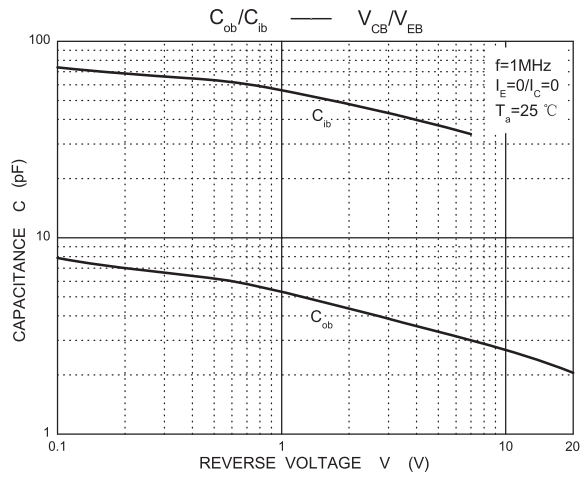

# SOT-23 OUTLINE DIMENSIONS

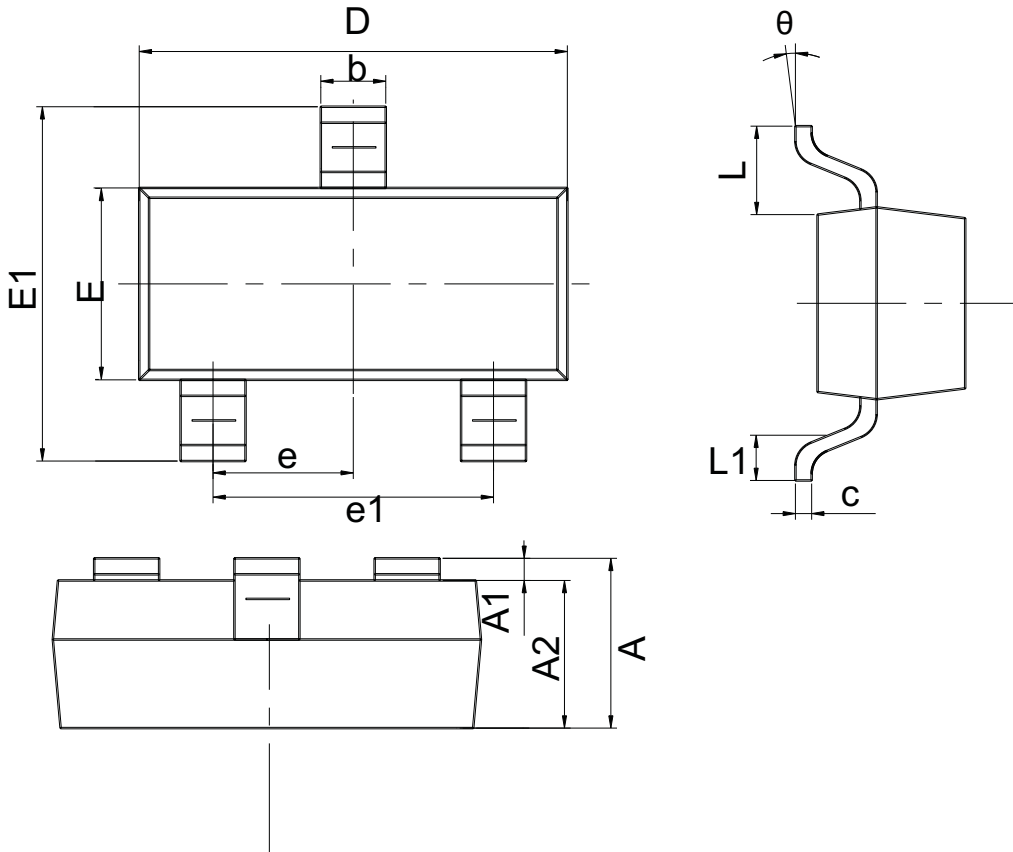

| symbol   | Dimensions In Millimeters |       | Dimensions In Inches |       |
|----------|---------------------------|-------|----------------------|-------|
|          | Min.                      | Max.  | Min.                 | Max.  |
| A        | 0.900                     | 1.150 | 0.035                | 0.045 |
| A1       | 0.000                     | 0.100 | 0.000                | 0.004 |
| A2       | 0.900                     | 1.050 | 0.035                | 0.041 |
| b        | 0.300                     | 0.500 | 0.012                | 0.020 |
| c        | 0.080                     | 0.150 | 0.003                | 0.006 |
| D        | 2.800                     | 3.000 | 0.110                | 0.118 |
| E        | 1.200                     | 1.400 | 0.047                | 0.055 |
| E1       | 2.250                     | 2.550 | 0.089                | 0.100 |
| e        | 0.950REF.                 |       | 0.037REF.            |       |
| e1       | 1.800                     | 2.000 | 0.071                | 0.079 |
| L        | 0.550REF                  |       | 0.022REF             |       |
| L1       | 0.300                     | 0.500 | 0.012                | 0.020 |
| $\theta$ | 0°                        | 8°    | 0°                   | 8°    |

# SOT-23 Tape and Reel

## SOT-23 Embossed Carrier Tape

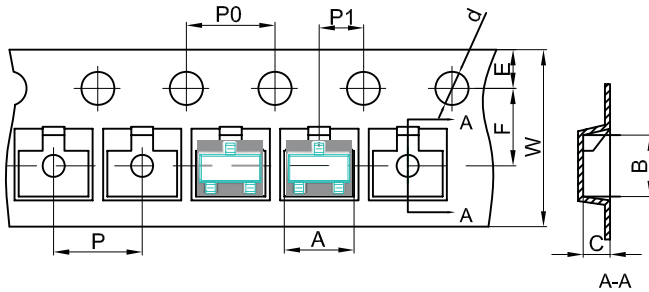

### Packaging Description:

SOT-23 parts are shipped in tape. The carrier tape is made from a dissipative (carbon filled) polycarbonate resin. The cover tape is a multilayer film (Heat Activated Adhesive in nature) primarily composed of polyester film, adhesive layer, sealant, and anti-static sprayed agent. These reeled parts in standard option are shipped with 3000 units per 7" or 17.8cm diameter reel. The reels are clear in color and is made of polystyrene plastic (anti-static coated).

| Dimensions are in millimeter |        |        |        |        |        |        |        |        |        |           |
|------------------------------|--------|--------|--------|--------|--------|--------|--------|--------|--------|-----------|
| Pkg type                     | A      | B      | C      | d      | E      | F      | P0     | P      | P1     | W         |
| SOT-23                       | 3.15   | 2.77   | 1.22   | Ø1.50  | 1.75   | 3.50   | 4.00   | 4.00   | 2.00   | 8.00      |
| (Tolerance)                  | +/-0.1 | +/-0.1 | +/-0.1 | +/-0.1 | +/-0.1 | +/-0.1 | +/-0.1 | +/-0.1 | +/-0.1 | +0.3/-0.1 |

## SOT-23 Tape Leader and Trailer

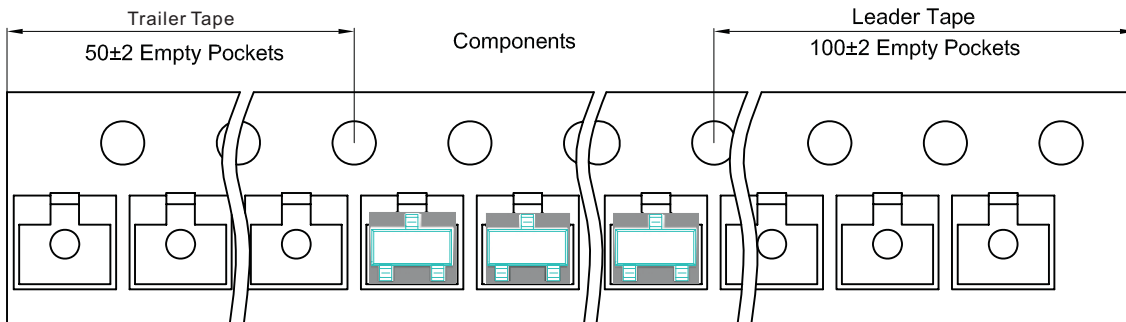

## SOT-23 Reel

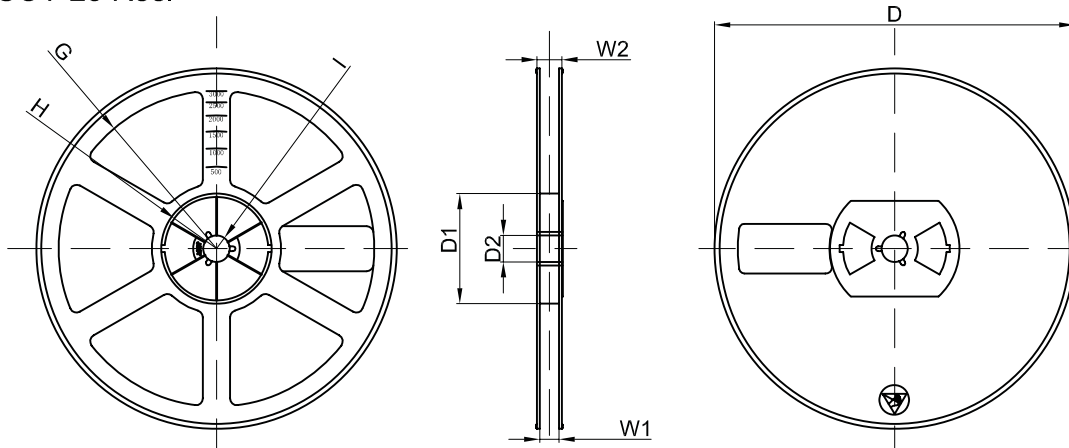

| Dimensions are in millimeter |         |       |       |        |        |       |      |       |
|------------------------------|---------|-------|-------|--------|--------|-------|------|-------|
| Reel Option                  | D       | D1    | D2    | G      | H      | I     | W1   | W2    |
| 7" Dia                       | Ø178.00 | 54.40 | 13.00 | R78.00 | R25.60 | R6.50 | 9.50 | 12.30 |
| Tolerance                    | +/-2    | +/-1  | +/-1  | +/-1   | +/-1   | +/-1  | +/-1 | +/-1  |

| REEL     | Reel Size | Box        | Box Size(mm) | Carton      | Carton Size(mm) | G.W.(kg) |
|----------|-----------|------------|--------------|-------------|-----------------|----------|
| 3000 pcs | 7 inch    | 45,000 pcs | 210x208x203  | 180,000 pcs | 440x440x230     | 8.45     |

# SOT-23 Pad size

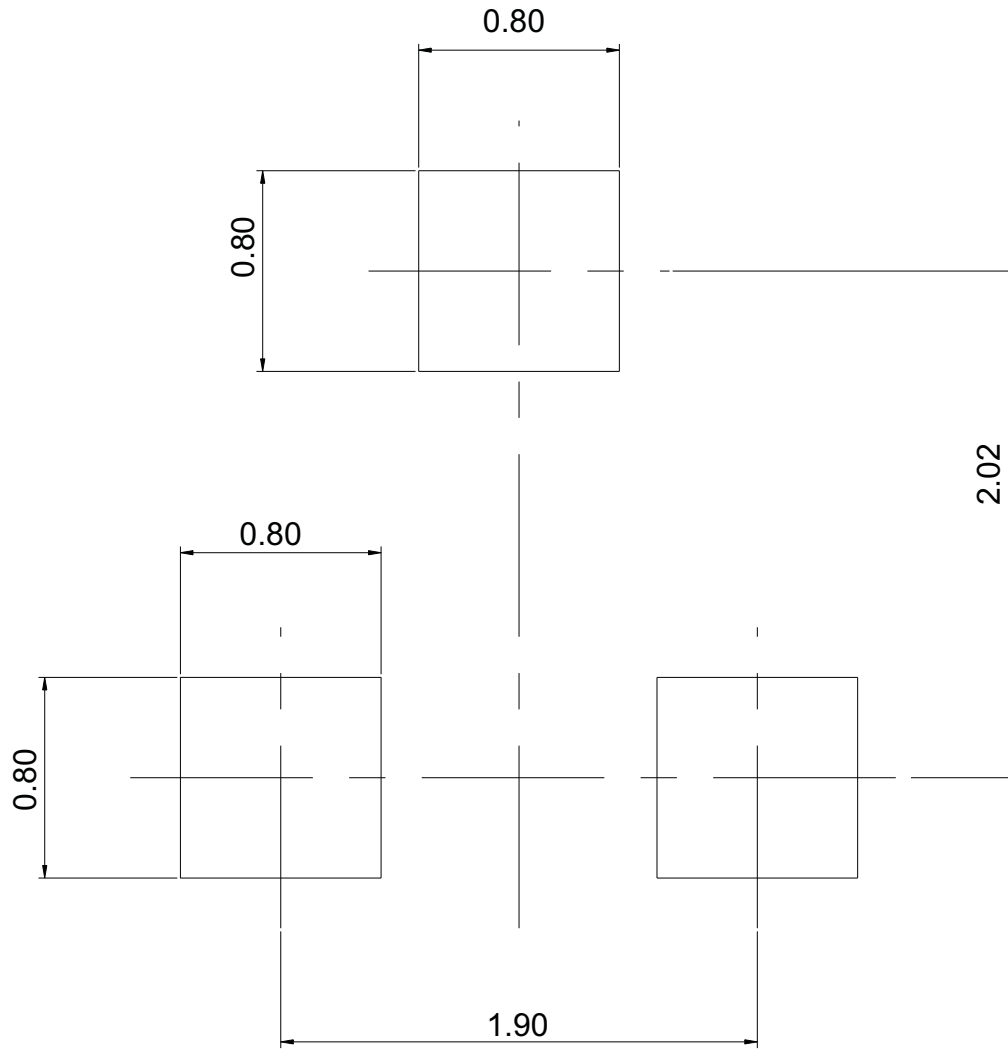

|                        |                    |      |
|------------------------|--------------------|------|
| <b>Center distance</b> |                    | 1.90 |
| <b>Lead size</b>       | <b>Lead width</b>  | 0.40 |
|                        | <b>Lead length</b> | 0.55 |
| <b>Pad size</b>        | <b>Pad width</b>   | 0.80 |
|                        | <b>Pad length</b>  | 0.80 |

Unit: mm