



### FEATURES

- NPN epitaxial silicon, planar design.
- Collector-emitter voltage  $V_{CE}=40V$ .
- Collector current  $I_C=0.6A$ .
- Transition frequency  $f_T > 250MHz$  @  $I_C=20mA_{dc}$ ,  $V_{CE}=20V_{dc}$ ,  $f=100MHz$ .
- In compliance with ER RoHS 2002/95/EC directives.



### MECHANICAL DATA

Case: SOT-23, Plastic  
 Terminals: Solderable per MIL-STD-750, method 2026  
 Approx. Weight: 0.008gram  
 Marking: 1P

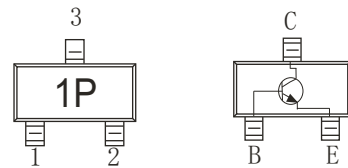

### MAXIMUM RATINGS ( $T_a=25^{\circ}C$ unless otherwise noted)

Symbol	Parameter	Vaule	Unit
$V_{CBO}$	Collector-Base Voltage	75	V
$V_{CEO}$	Collector-Emitter Voltage	40	V
$V_{EBO}$	Emitter-Base Voltage	6	V
$I_C$	Collector Current	0.6	A
$P_C$	Total Device Dissipation	0.3	W
$R_{\theta JA}$	Thermal Resistance Form Junction to Ambient	416	$^{\circ}C/W$
$T_J$	Junction Temperature	150	$^{\circ}C$
$T_{STG}$	Storage Temperature	-55~+150	$^{\circ}C$

# MMBT222A

## ELECTRICAL CHARACTERISTICS (Ta=25°C unless otherwise specified)

Parameter	Symbol	Test Condition	Min.	Typ.	Max.	Units
Collector-Base breakdown voltage	$V_{(BR)CBO}$	$I_C=100\mu A, I_E=0$	75			V
Collector-Emitter breakdown voltage	$V_{(BR)CEO}$	$I_C=1mA, I_B=0$	40			V
Emitter-Base breakdown voltage	$V_{(BR)EBO}$	$I_E=100\mu A, I_C=0$	6			V
Collector cut-off current	$I_{CBO}$	$V_{CB}=60V, I_C=0$			0.01	$\mu A$
Collector cut-off current	$I_{CEX}$	$V_{CE}=60V, I_B=0$			0.01	$\mu A$
Base cut-off current	$I_{BEX}$				0.1	$\mu A$
Emitter cut-off current	$I_{EBO}$	$V_{EB}=4V, I_C=0$			0.1	$\mu A$
DC current gain*	$H_{FE}$	$I_C=1mA, V_{CE}=10V$	10			
	$H_{FE}$	$I_C=0.1mA, V_{CE}=10V$	40			
	$H_{FE}$	$I_C=150mA, V_{CE}=10V$	100		300	
	$H_{FE}$	$I_C=500mA, V_{CE}=10V$	40			
	$H_{FE}$	$I_C=200mA, V_{CE}=10V$	30			
Collector-Emitter saturation voltage	$V_{CE(SAT)}$	$I_C=100mA, I_B=10mA$			0.2	V
		$I_C=500mA, I_B=50mA$			1	V
Base-Emitter Saturation voltage*	$V_{BE(SAT)}$	$I_C=100mA, I_B=10mA$			1.1	V
		$I_C=500mA, I_B=50mA$			2	V
Input capacitance	$C_{IB}$	$V_{CB}=6V, I_E=0, f=1MHz$			4.0	pF
Output capacitance	$C_{OB}$	$V_{EB}=0.5V, I_C=0, f=1MHz$			8.0	pF
Transition frequency	$f_T$	$I_C=20mA, V_{CE}=20V, f=100MHz$	250			MHz
Delay time	$t_d$	$V_{CC}=30V, V_{BE}=-0.5V, I_C=150mA, I_B=15mA$			35	nS
Rise time	$t_r$				35	nS
Storage time	$t_s$	$V_{CC}=30V, V_{BE}=-0.5V, I_{B1}=I_{B2}=15mA$			200	nS
Fall time	$t_f$				50	nS

\*Pulse Test: Pulse Width<300 $\mu$ S, Duty Cycle<2.0%.

# MMBT2222A

## ELECTRICAL CHARACTERISTICS (Ta=25°C unless otherwise specified)

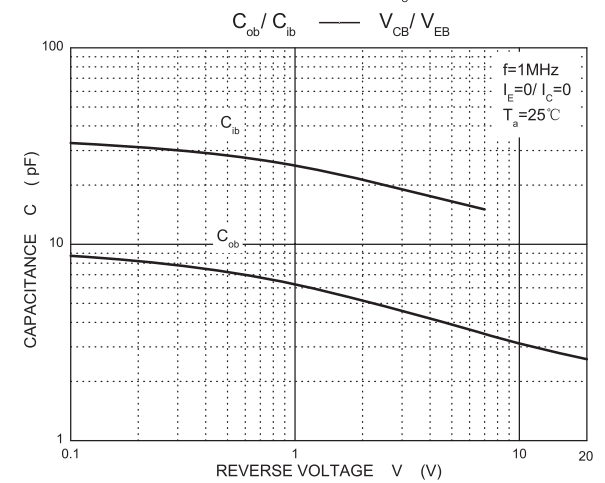
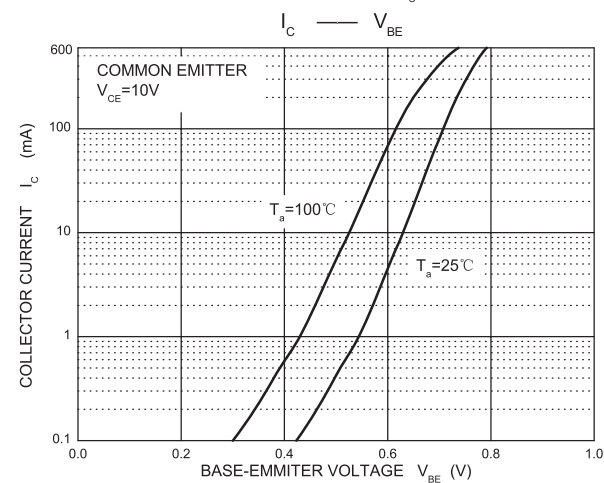
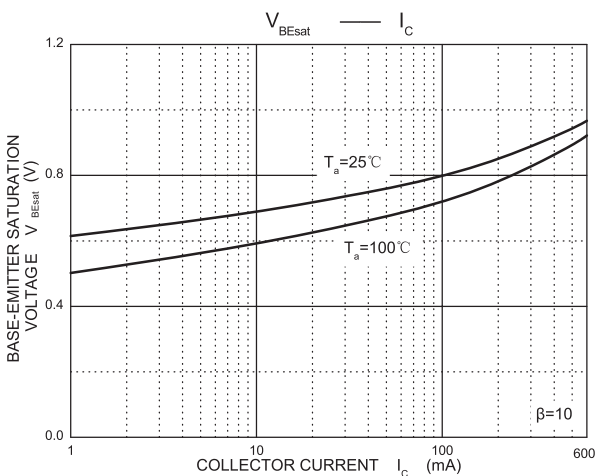
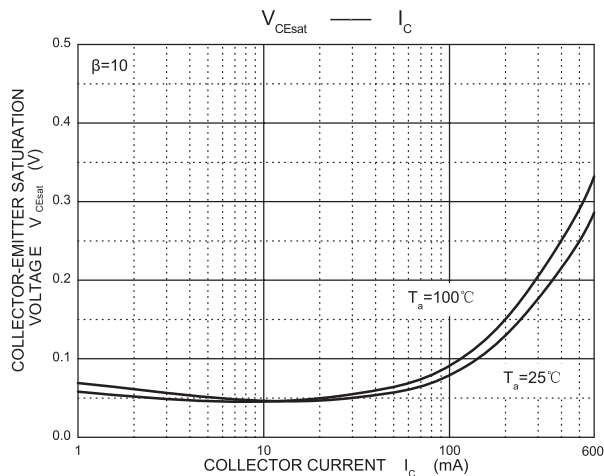
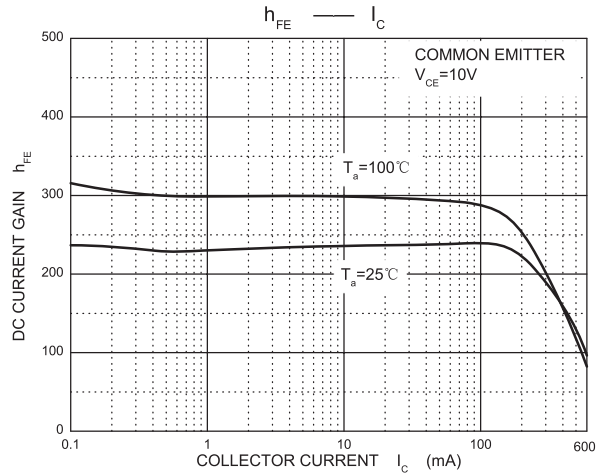
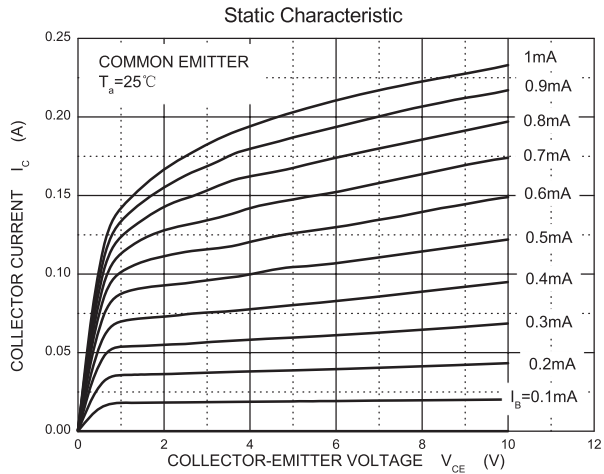

# MMBT2222A

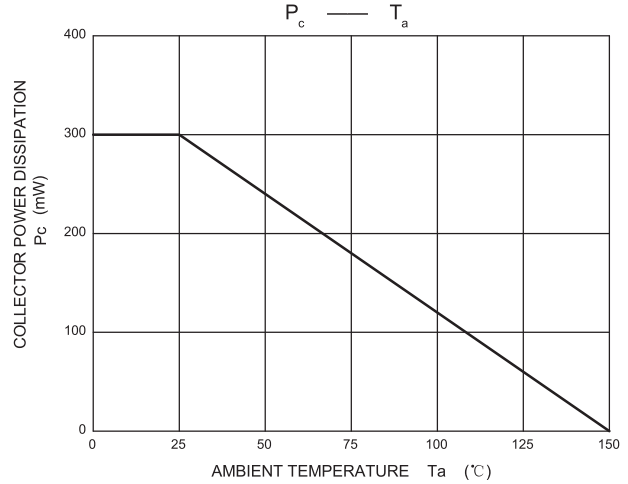
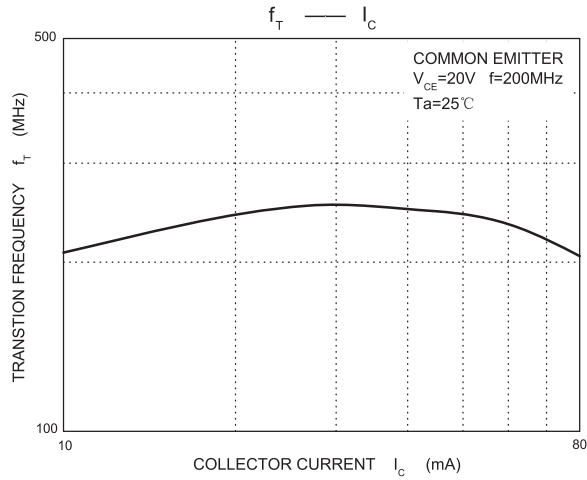

# SOT-23 OUTLINE DIMENSIONS

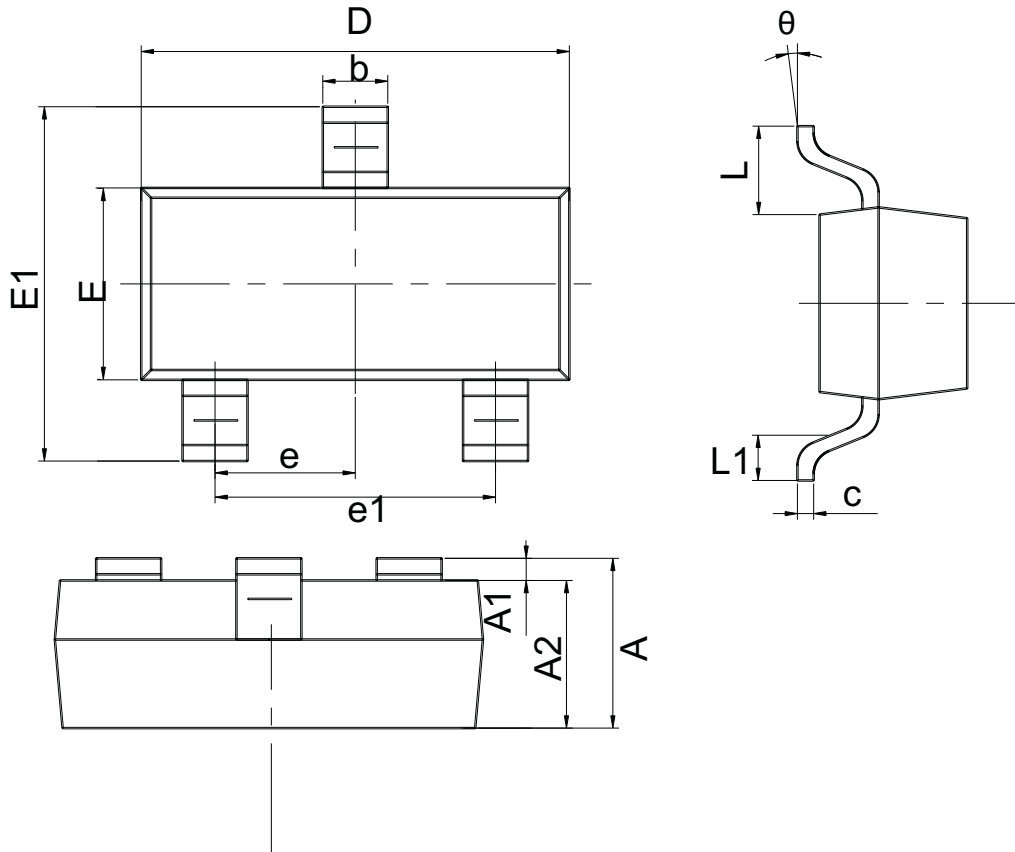

symbol	Dimensions In Millimeters		Dimensions In Inches	
	Min.	Max.	Min.	Max.
A	0.900	1.150	0.035	0.045
A1	0.000	0.100	0.000	0.004
A2	0.900	1.050	0.035	0.041
b	0.300	0.500	0.012	0.020
c	0.080	0.150	0.003	0.006
D	2.800	3.000	0.110	0.118
E	1.200	1.400	0.047	0.055
E1	2.250	2.550	0.089	0.100
e	0.950REF.		0.037REF.	
e1	1.800	2.000	0.071	0.079
L	0.550REF		0.022REF	
L1	0.300	0.500	0.012	0.020
$\theta$	0°	8°	0°	8°

# SOT-23 Tape and reel

## SOT-23 Embossed Carrier Tape

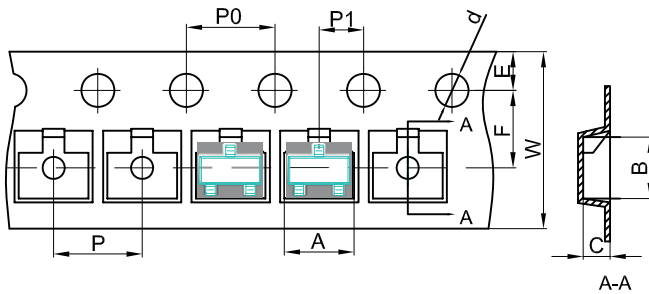

### Packaging Description:

SOT-23 parts are shipped in tape. The carrier tape is made from a dissipative (carbon filled) polycarbonate resin. The cover tape is a multilayer film (Heat Activated Adhesive in nature) primarily composed of polyester film, adhesive layer, sealant, and anti-static sprayed agent. These reeled parts in standard option are shipped with 3000 units per 7" or 17.8cm diameter reel. The reels are clear in color and is made of polystyrene plastic (anti-static coated).

Dimensions are in millimeter										
Pkg type	A	B	C	d	E	F	P0	P	P1	W
SOT-23	3.15	2.77	1.22	Ø1.50	1.75	3.50	4.00	4.00	2.00	8.00
(Tolerance)	+/-0.1	+/-0.1	+/-0.1	+/-0.1	+/-0.1	+/-0.1	+/-0.1	+/-0.1	+/-0.1	+0.3/-0.1

## SOT-23 Tape Leader and Trailer

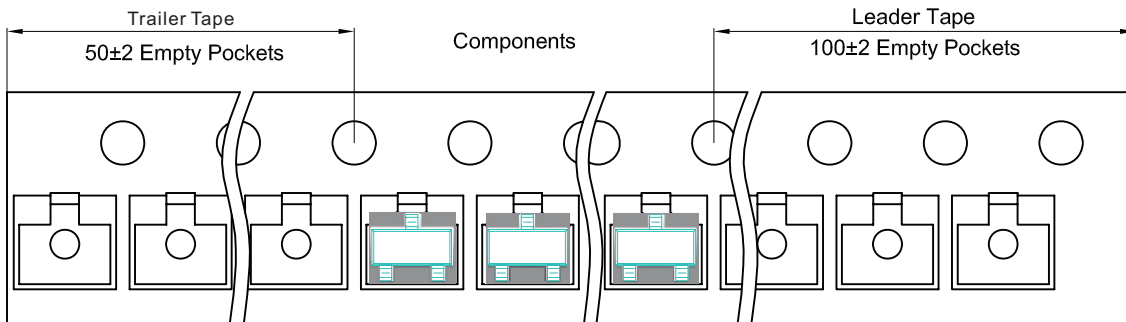

## SOT-23 Reel

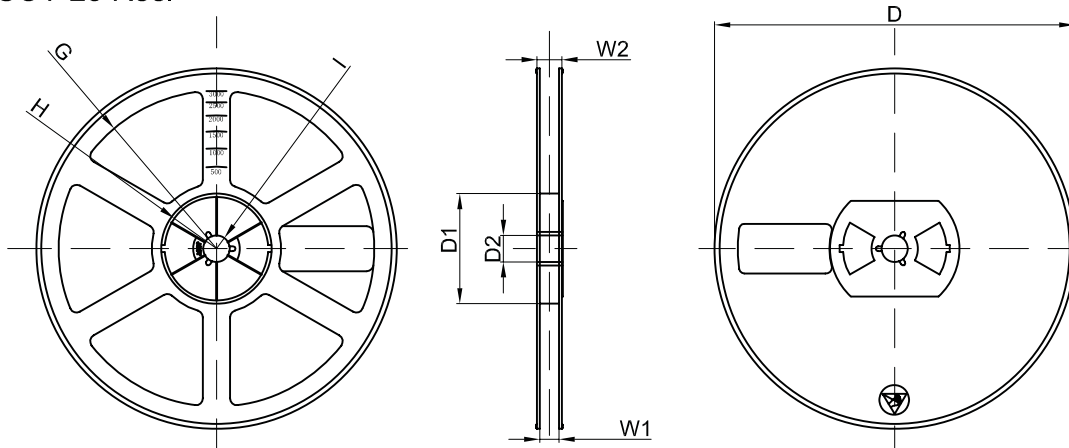

Dimensions are in millimeter								
Reel Option	D	D1	D2	G	H	I	W1	W2
7" Dia	Ø178.00	54.40	13.00	R78.00	R25.60	R6.50	9.50	12.30
Tolerance	+/-2	+/-1	+/-1	+/-1	+/-1	+/-1	+/-1	+/-1

REEL	Reel Size	Box	Box Size(mm)	Carton	Carton Size(mm)	G.W.(kg)
3000 pcs	7 inch	45,000 pcs	210x208x203	180,000 pcs	440x440x230	8.45

# SOT-23 Pad size

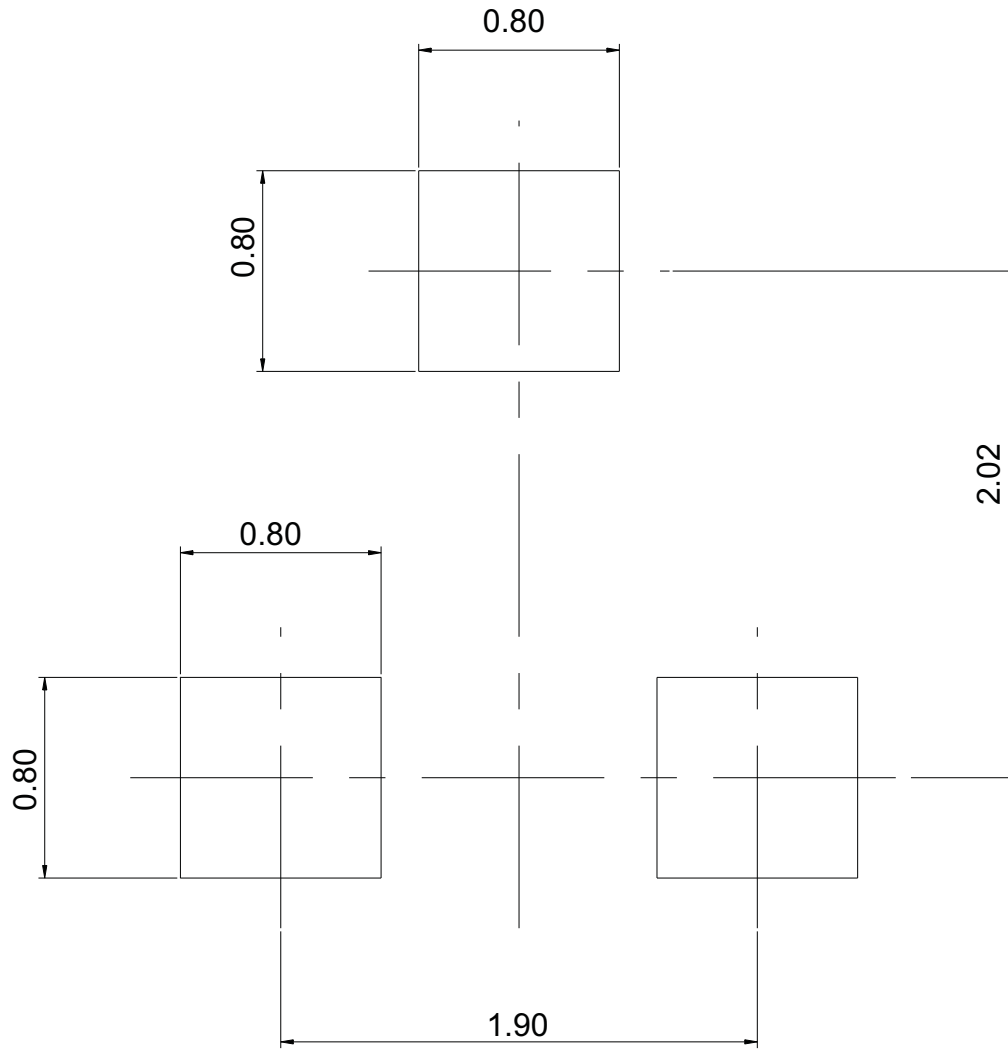

<b>Center distance</b>		1.90
<b>Lead size</b>	<b>Lead width</b>	0.40
	<b>Lead length</b>	0.55
<b>Pad size</b>	<b>Pad width</b>	0.80
	<b>Pad length</b>	0.80

Unit: mm