

P-Channel Enhancement Mode Power MOSFET

Description

The 7409B uses advanced trench technology to provide excellent $R_{DS(ON)}$, low gate charge and operation with gate voltages as low as 4.5V.

General Features

- $V_{DS} = -30V, I_D = -25A$
 $R_{DS(ON)} < 30m\Omega @ V_{GS} = -4.5V$
 $R_{DS(ON)} < 17m\Omega @ V_{GS} = -10V$
- High power and current handing capability
- Lead free product is acquired
- Surface mount package

Application

- Battery Switch
- Load switch
- Power management

PDFN3X3-8L

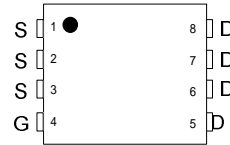

Equivalent Circuit

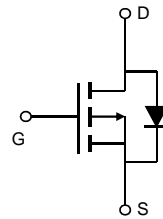

MARKING



Y :year code W :week code

Absolute Maximum Ratings ($T_A = 25^\circ C$ unless otherwise noted)

Parameter	Symbol	Limit	Unit
Drain-Source Voltage	V_{DS}	-30	V
Gate-Source Voltage	V_{GS}	± 20	V
Continuous Drain Current ($T_J = 150^\circ C$)	I_D	$T_A = 25^\circ C$	-10
		$T_A = 70^\circ C$	-8.0
Drain Current-Pulsed (Note 1)	I_{DM}	-45	A
Maximum Power Dissipation	P_D	3.1	W
Operating Junction and Storage Temperature Range	T_J, T_{STG}	-55 To 150	$^\circ C$

Thermal Characteristic

Thermal Resistance, Junction-to-Ambient (Note 2)	$R_{\theta JA}$	40	$^\circ C/W$
--	-----------------	----	--------------

Electrical Characteristics ($T_A=25^{\circ}\text{C}$ unless otherwise noted)

Parameter	Symbol	Condition	Min	Typ	Max	Unit
Off Characteristics						
Drain-Source Breakdown Voltage	BV_{DSS}	$V_{GS}=0V, I_D=-250\mu A$	-30	-33	-	V
Zero Gate Voltage Drain Current	I_{DSS}	$V_{DS}=-30V, V_{GS}=0V$	-	-	-1	μA
Gate-Body Leakage Current	I_{GSS}	$V_{GS}=\pm 20V, V_{DS}=0V$	-	-	± 100	nA
On Characteristics (Note 3)						
Gate Threshold Voltage	$V_{GS(th)}$	$V_{DS}=V_{GS}, I_D=-250\mu A$	1.0	1.7	3.0	V
Drain-Source On-State Resistance	$R_{DS(on)}$	$V_{GS}=-10V, I_D=-10A$	-	14	17	$m\Omega$
		$V_{GS}=-4.5V, I_D=-10A$	-	25	30	$m\Omega$
Forward Transconductance	g_{FS}	$V_{DS}=-15V, I_D=-10A$	10	-	-	S
Dynamic Characteristics (Note 4)						
Input Capacitance	C_{iss}	$V_{DS}=-15V, V_{GS}=0V,$ $F=1.0MHz$	-	1600	-	PF
Output Capacitance	C_{oss}		-	350	-	PF
Reverse Transfer Capacitance	C_{rss}		-	300	-	PF
Switching Characteristics (Note 4)						
Turn-on Delay Time	$t_{d(on)}$	$V_{DD}=-15V, I_D=-1A,$ $V_{GS}=-10V, R_{GEN}=6\Omega$	-	10	-	nS
Turn-on Rise Time	t_r		-	15	-	nS
Turn-Off Delay Time	$t_{d(off)}$		-	110	-	nS
Turn-Off Fall Time	t_f		-	70	-	nS
Total Gate Charge	Q_g	$V_{DS}=-15V, I_D=-10A$ $V_{GS}=-10V$	-	30	-	nC
Gate-Source Charge	Q_{gs}		-	5.5	-	nC
Gate-Drain Charge	Q_{gd}		-	8	-	nC
Drain-Source Diode Characteristics						
Diode Forward Voltage	V_{SD}	$V_{GS}=0V, I_S=-10A$	-	-	1.2	V

Notes:

1. Repetitive Rating: Pulse width limited by maximum junction temperature.
2. Surface Mounted on FR4 Board, $t \leq 10$ sec.
3. Pulse Test: Pulse Width $\leq 300\mu s$, Duty Cycle $\leq 2\%$.
4. Guaranteed by design, not subject to production

Typical Electrical and Thermal Characteristics

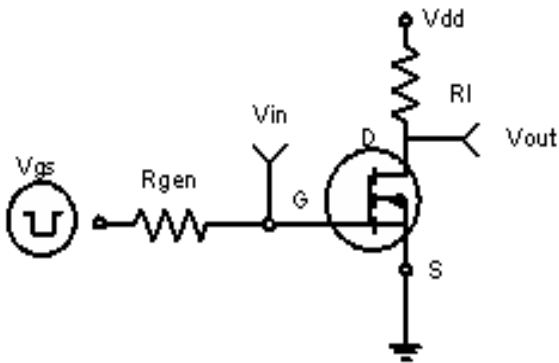

Figure 1: Switching Test Circuit

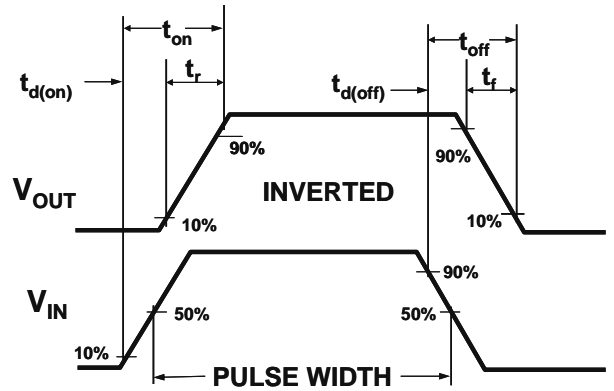

Figure 2: Switching Waveforms

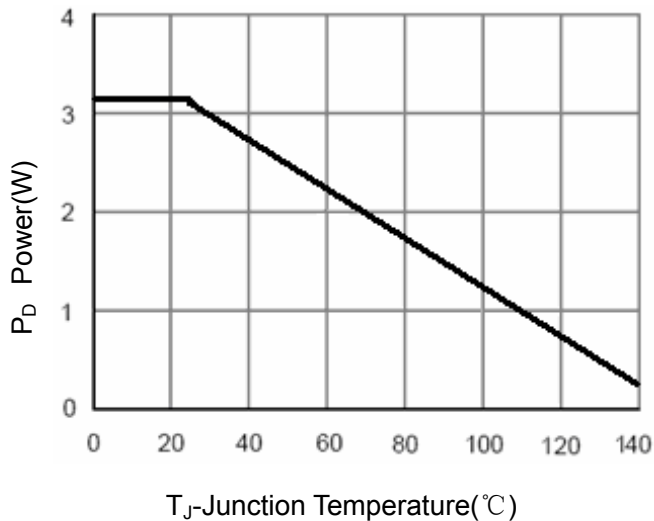

Figure 3 Power Dissipation

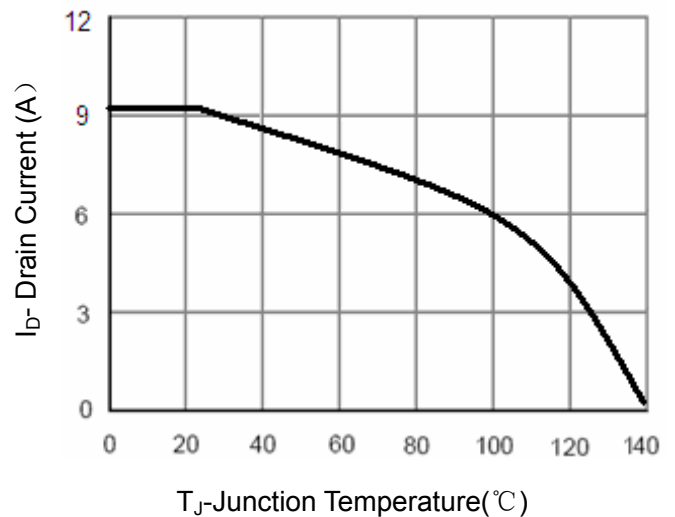

Figure 4 Drain Current

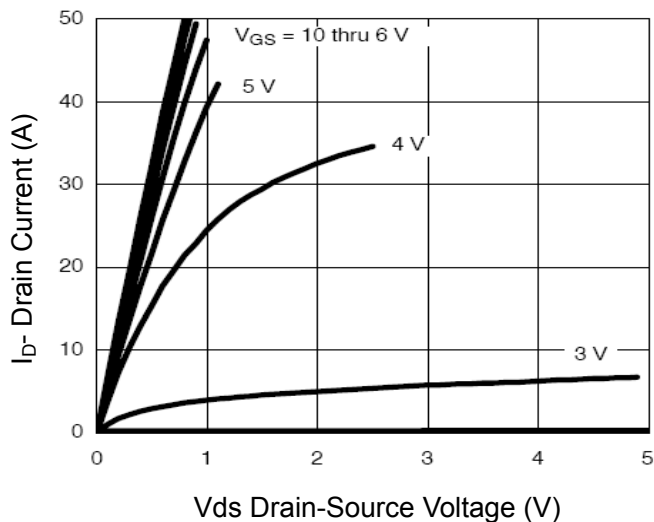

Figure 5 Output Characteristics

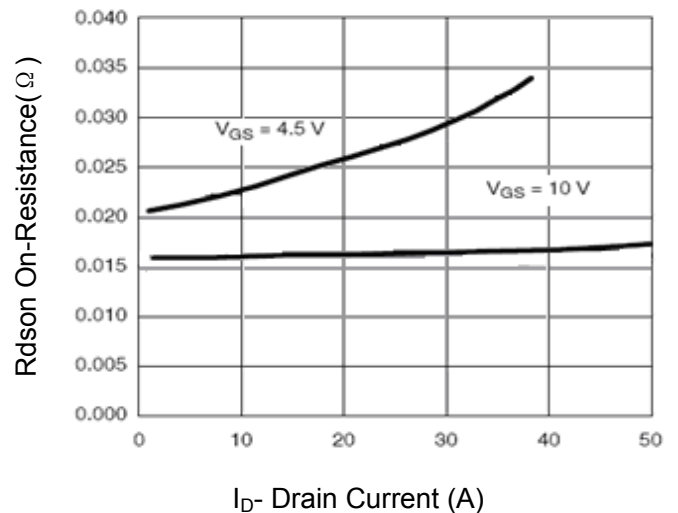

Figure 6 Drain-Source On-Resistance

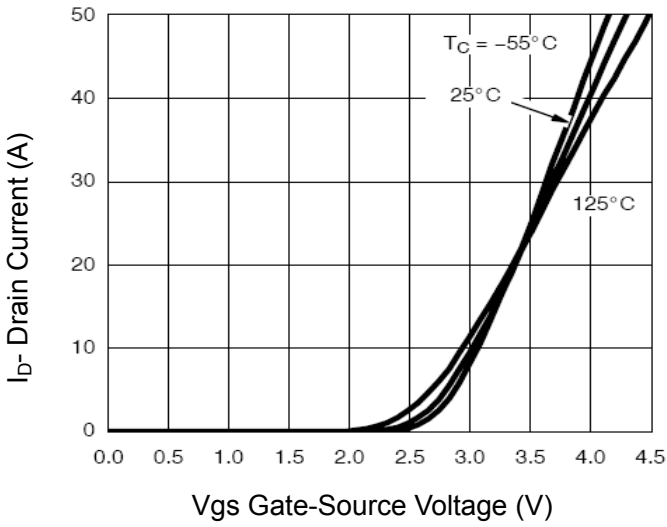

Figure 7 Transfer Characteristics

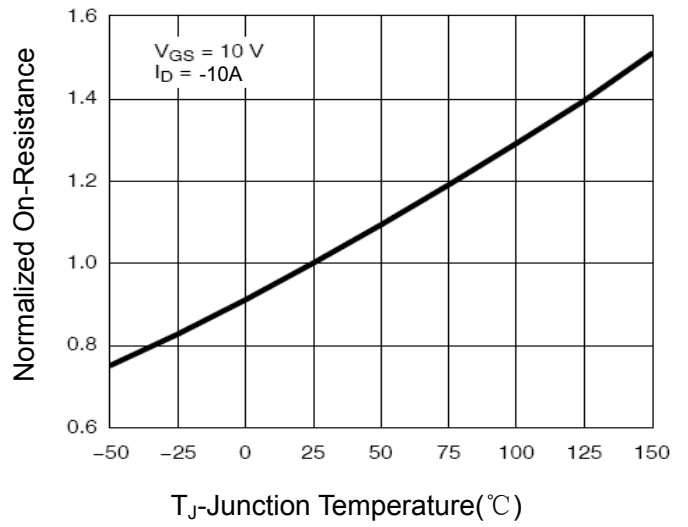

Figure 8 Drain-Source On-Resistance

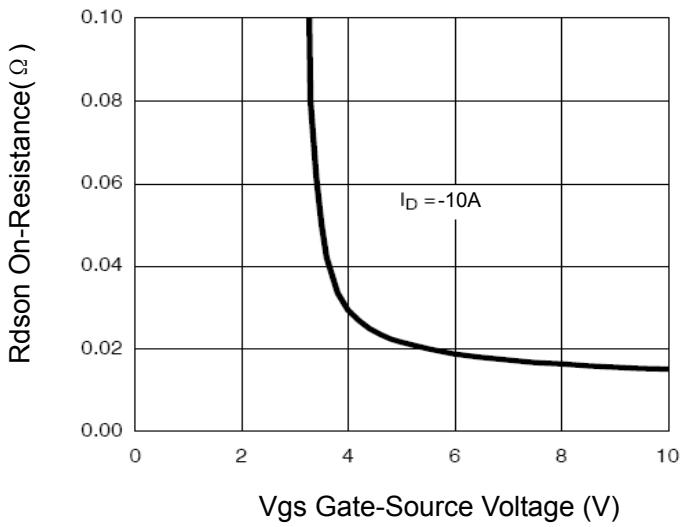

Figure 9 Rdson vs Vgs

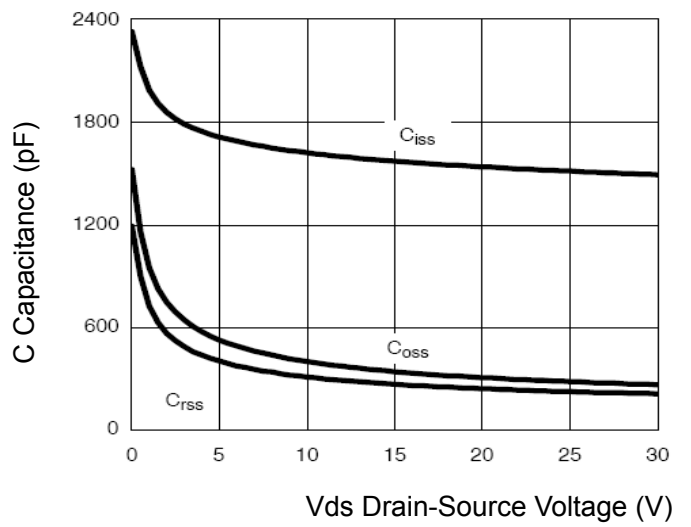

Figure 10 Capacitance vs Vds

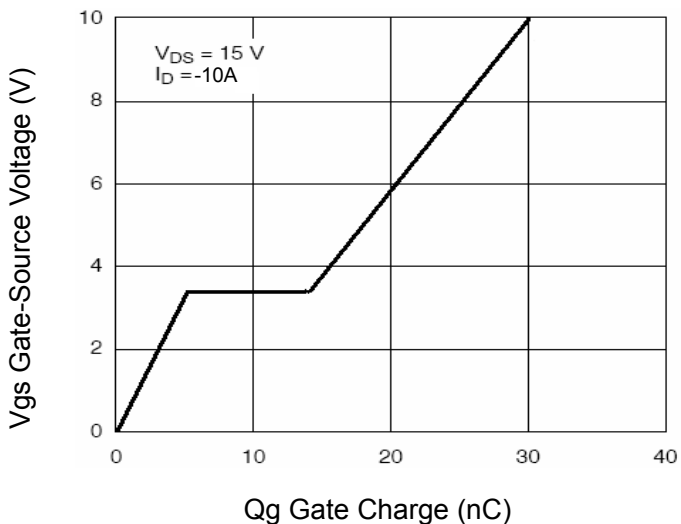

Figure 11 Gate Charge

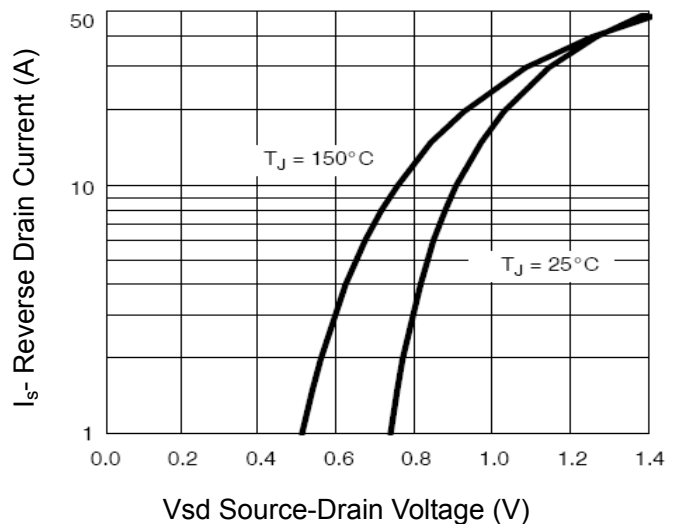

Figure 12 Source- Drain Diode Forward

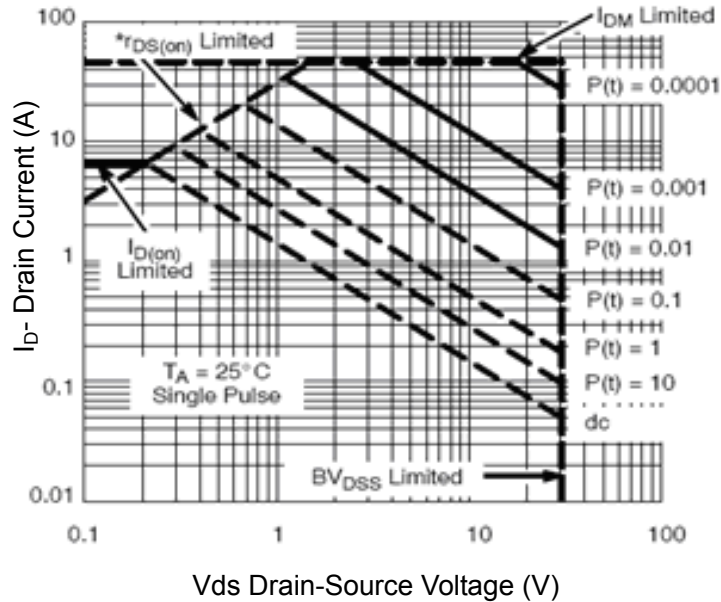

Figure 13 Safe Operation Area

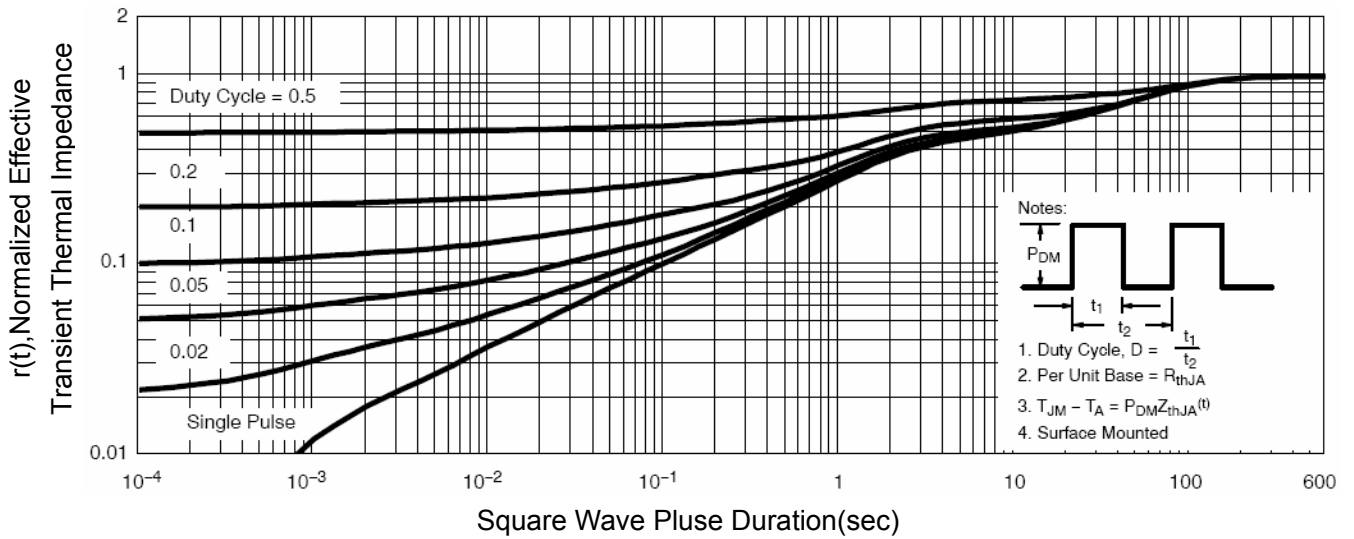

Figure 14 Normalized Maximum Transient Thermal Impedance

PDFN 3x3 Plastic-Encapsulate MOSFETS

7409B

Package Information

PDFN3333

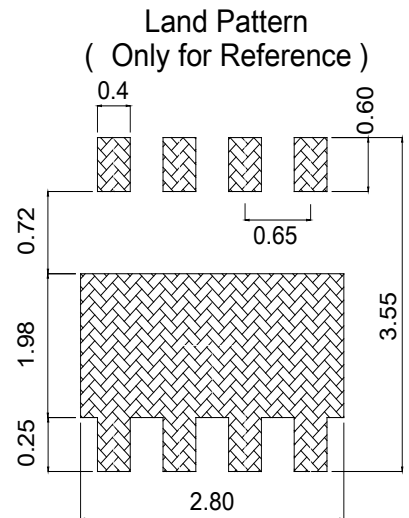
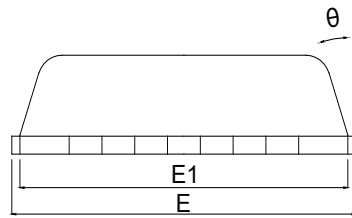
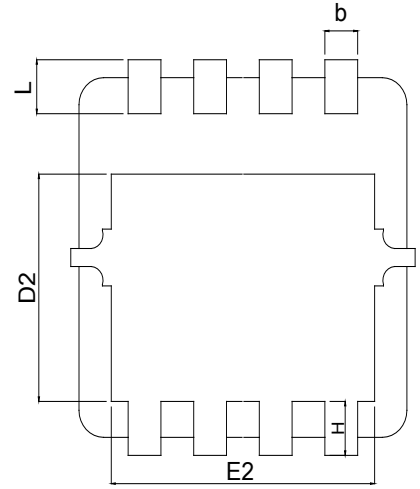
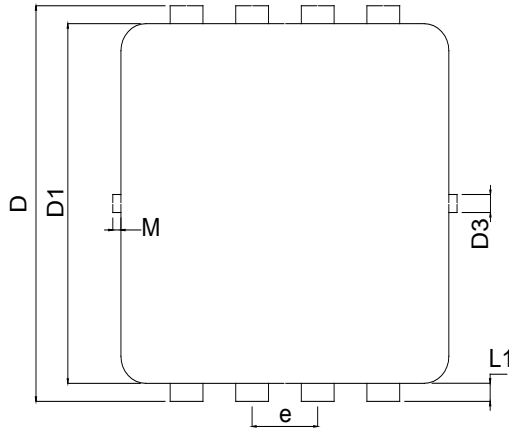
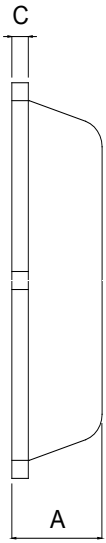

SYMBOL	MM			INCH			SYMBOL	MM			INCH		
	MIN	NOM	MAX	MIN	NOM	MAX		MIN	NOM	MAX	MIN	NOM	MAX
A	0.70	0.75	0.80	0.028	0.030	0.031	E1	3.00	3.15	3.20	0.118	0.122	0.126
b	0.25	0.30	0.35	0.010	0.012	0.014	E2	2.39	2.49	2.59	0.094	0.098	0.102
c	0.10	0.15	0.25	0.004	0.007	0.010	e	0.65BSC			0.026BSC		
D	3.25	3.35	3.45	0.128	0.132	0.136	H	0.30	0.40	0.50	0.012	0.016	0.020
D1	3.00	3.10	3.20	0.118	0.122	0.126	L	0.30	0.40	0.50	0.012	0.016	0.020
D2	1.78	1.88	1.98	0.070	0.074	0.078	L1	*	0.13	*	*	0.005	*
D3	*	0.13	*	*	0.005	*	θ	*	10°	12°	*	10°	12°
E	3.20	3.30	3.40	0.126	0.130	0.134	M	*	*	0.15	*	*	0.006