



东莞市汉博电子科技有限公司

Dongguan Hanbo Electronic Technology Co., Ltd

承 认 书

SPECIFICATION FOR APPROVAL

客 户Customer:

产品名称Project:

轻触开关

规格型号Part No:

TS-KG001T

贵公司承认印 Approval signatures

料 号/Part No.	签 章/Signatures

Thank you for your support

日期 Date:

网址 : <http://www.hanbodianzi.com>
alibaba:<https://hanbodianzii.1688.com/>

电话/TEL: 17818537717 黄达

TEL : 17818910097 林振强

传真/FAX: 0769-82866750

邮箱 : hanbodianz@foxmail.com

拟制/Drawn	潘伟皇
审核/Check	丁熊钊
批准/Approved	李国栋 工程部

企业客服QQ: 578882810 黄生
2293580177 林生

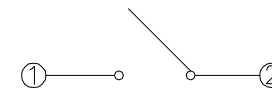
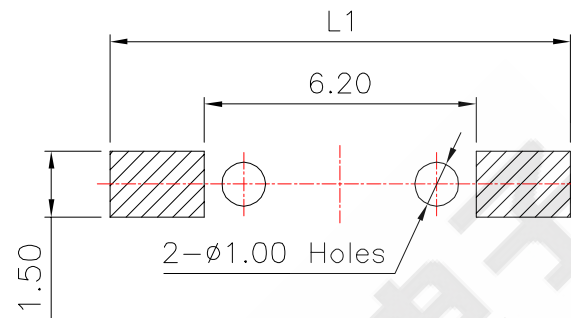
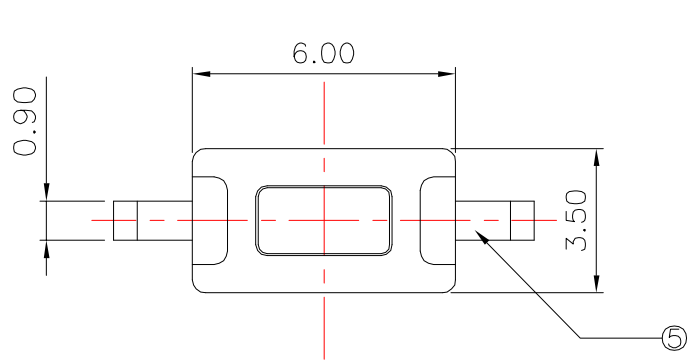

Circuit Diagram

NO.2	
PART NO	VIGOR
1	90±30
2	130±30
3	180±30
4	250±30
5	350±50

NO.3	
PART NO	MATERIAL/QTY
S	SUS/1PC
D	SUS/2PCS

NO.4		
PART NO	L	L1
A	8	10
B	8.5	11
C	9	11
D	9.5	12
E	10	12

NO.5-NO.6	
PART NO	NOTE
01~99	SERIAL NUMBER

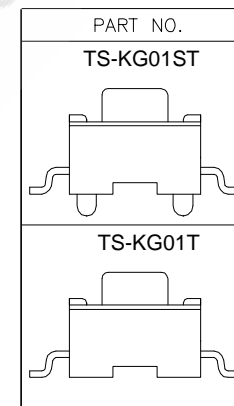

NO.1	
PART NO	H
A	4.3
C	5

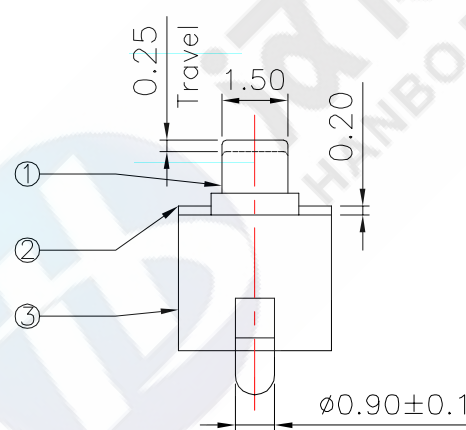
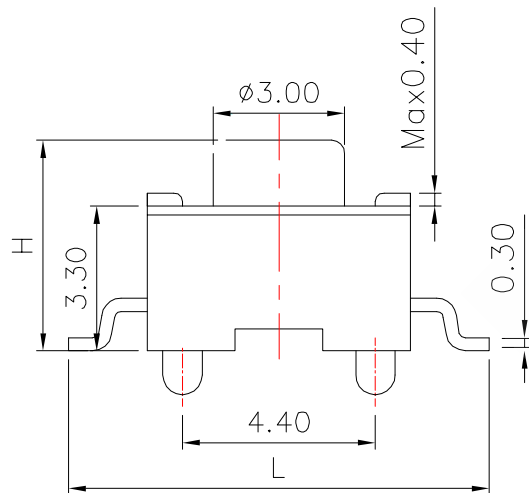

⑤	Terminal	—	2	Brass(0.30t)	Plating silver	—
④	Contact	—	1	F.Ag/SUS	—	—
③	Base	—	1	PA46	WHITE	—
②	Cover	—	1	SPCC	Plating Nickel	—
①	Keystoke	—	1	PA46	WHITE	—
ITEM	PART NAME	ER'NO.	QTY.	MATERIAL	FINISHING	REMARK



东莞市汉博电子科技有限公司

UNLESS OTHERWISE SPECIFIED TOLERANCES

TOLERANCE	ANGLE
30- 以上 ±0.30	± 2°
10-30 ±0.20	
5-10 ±0.15	
-5 ±0.10	



PART NAME:		
3*6正接贴片式轻触开关		
PART NO.	TS-KG001T	
DWN	潘伟星	2013/06/30
CHKD	丁熊利	
APVD	李国栋	
SCALE 1:1	UNIT: mm	
SIZE: A4	SHEET: 10F1	REV: A

ECN NO.	REV.	DATE.	DESCRIPTION.	CHANGE.	CHECK.	APPRO.
	A		NEW			



SPECIFICATION

1、General Charactenstics 一般特性：

1.1 适用范围

APPLICATION

此规格书适用于机械式轻触开关的相关要求

This specification is applied to the requirements for TACTILE SWITCH (MECHANICAL CONTACT)

1.2 工作温度范围

Operating Temperature Range

-20°C~80°C (在标准大气压、标准湿度条件下)

-20°C~80°C (Normal humidity, normal air pressure)

1.3 Operating Relative Humidity. 85%RH
相对湿度 85%RH

1.4 Test Conditions Unless otherwise specified the atmospheric conditions for making measurements and tests are as follows:

实验条件：若无特别说明，测试大气条件如下：

Ambient Temperature: 5-35 °C, Relative humidity: 45-85%

环境温度：5-35 °C 相对湿度：45-85%

大气压力：86-106Kpa(860-1060mbar)

2. Appearance ; The switch shall have good finishing, and no rust crack or plating defects.

外观：产品外观良好，无锈腐、裂纹和镀层缺陷

2.1 Structure Dimensions: Refer to individual product drawing.

结构及尺寸：参加产品图纸

3. Ratings 额定负荷

DC12V 50mA

4. Electrical Characteristics 电气特性

4.1	接触电阻 Contact Resistance	100mΩ Max.	在以5V 10mA 的直流电源或不低于1KHz 的交流电源的电路中以一个等于2倍按力的静负荷施加于手柄中心 Applying a static load of 2 times operating force to the center of the stem, measurements shall be made by 5V DC 10mA or more than 1KHZ AC small-current contact resistance meter
4.2	绝缘电阻 Insulation Resistance	100mΩ Min.	measurement shall be made following application of 100V DC potential across terminals, and across terminals and cover, for one minute 在端子之间施加DC 100V/1min的条件下测量端子之间底座、盖板的电阻值
4.3	抗电强度 Dielectric Voltage	No dielectric breakdown shall occur. 无击穿现象发生。	250VAC (50-60HZ, cutoff current 2mA) is applied between non-connected terminals and between terminals and the metal frame for 60±5S 在相互绝缘的所有接线端子之间250V (50-60Hz) 交流电，持续时间60±5S

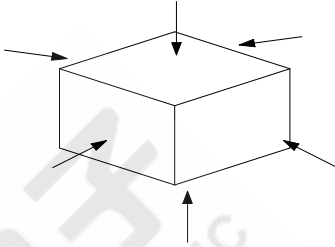

SPECIFICATION

No.	Item项目	Criteria 标准	Test Method 实验方法
5.6	Mechanical Shock 冲击	<p>After test, Contact resistance:200 mΩMax No functional defective occur Shall be free from mechanical abnormalities. 实验后: 接触电阻:200 m Max. 无功能性不良。 表面无变形且操作无异常</p>	<p>Switch shall be measured after following test: (1) Mounting Method: Normal (2) Acceleration: 490m/s(50G) (3) Duration: 11ms (4) Test Direction: 6 directions</p>  <p>(5) Number of shocks: 3 times per direction (18 times in total) 试件在下述参数条件下进行试验: (1) 安装方法: 常规方法 (2) 加速度: 490m/s²(50G) (3) 时间: 11ms (4) 试验方向: 图示6方向 (5) 冲击速度: 每个方向3次(总共18次)</p>
5.7	Solder Ability 可焊性	<p>More than 90% of immersed part shall be covered with solder. 超过90%的浸锡面积被焊料所覆盖。</p>	<p>The switch is tested under the following parameters: (1) Equipment: automatic welding machine (2) Solder: General (3) Flux: a colorless transparent solution of 25% rosin and 75% methanol (4) Welding temperature: 260 ± 5 °C (5) Immersion time: 3 ± 1s (6) Immersion depth: the terminal shall be immersed in the root of the switch</p> <p>开关在下述参数条件下进行试验: (1) 设备: 自动焊接机 (2) 焊料: 常规 (3) 焊剂: 焊剂质量百分比为25%松香为75%甲醇的无色透明溶液。 (4) 焊接温度: 260±5°C (5) 浸渍时间: 3±1S (6) 浸渍深度: 接线端应浸到开关根部处</p>



SPECIFICATION

5. Mechanical Characteristics 机械特性

No.	Item 项目	Criteria 标准	Test Method 实验方法
5.1	Operating Force 操作力	160±30gf	At the end of the operating element, the static load is applied evenly along the operation direction, so that the operating element is transferred to the action position 在操作元件末端沿操作方向均匀施加静载荷，使操作元件转换到动作位置。
5.2	Return Force 回弹力	90 gfMin	At the end of the operating element, the static load is evenly reduced along the operation direction, so that the operating element can be transferred from the action position to the free position 在操作元件末端沿操作方向均匀减少静载荷，使操作元件从动作位置. 转换到自由位置
5.3	Operation Position 操作位置	0.16±0.05mm	The switch is placed perpendicular to the operation direction, and a static load equal to 2 times of the pressing force is applied to the top center of the switch driver, and the distance of the top moving is measured. 开关垂直于操作方向放置，以一个等于2倍按力的静负荷施加在开关驱动件顶端中心，测量顶端移动的距离。
5.4	Terminal Strength 端子强度	Shall be free from terminal looseness damage and insulation breakage. No functional defective occur 端子无松动，损坏及绝缘层的破裂。无功能性不良	A force of 0.5N is applied to the terminal 10 ± 1s along the axial direction (the force direction is to leave the switch outward), and the measurement is conducted once for each terminal. 以0.5N作用力沿轴向逐渐施加于接线端末10±1S（作用力方向为离开开关向外指向），每个接线端子测量一次。
5.5	Vibration Proof 振动	After the experiment: Contact resistance: 200m Ω max There was no dysfunction. The surface and structure have no obvious deformation 实验后： 接触电阻 :200m Ω Max. 无功能性不良。 表面及结构无明显变形	The switch can be installed firmly on the test equipment and tested under the following parameters: (1) Vibration frequency 10-55hz (2) The amplitude is 1.55mm (3) Vibration change rate: 10-55-10hz, about 1 minute (4) Frequency conversion method: logarithmic or linear (5) Vibration direction: three mutually perpendicular directions, one of which should be the direction of actuator movement. (6) Time: 2 hours in each direction (6 hours in total) 开关才有常规的安装方法牢固地安装在试验设备上，并在下述参数条件下进行试验： (1)振频10-55Hz (2) 振幅1.55mm (3) 振动变化速率：10-55-10Hz 大约1分钟 (4) 变频方法：对数或线性型式 (5) 振动方向：三个相互垂直的方向，其中一个方向应是促动元件运动的方向。 (6) 时间：每个方向2个小时（共6小时）

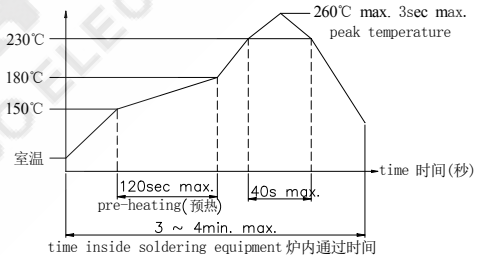

SPECIFICATION

No.	Item项目	Criteria 标准	Test Method 实验方法
5.8	Solder Heat Resistance 耐焊接热	NO abnormalities shall be observed in appearance and operation. No functional defective occur 无外观及功能损坏 无功能性不良。	<p>Please practice according to below condition:</p> <p>(1) preheat: 150° C 90-120s</p> <p>(2) Soldering heat: 260° C Max 10S</p> <p>(3) Immersion depth: Up to the surface of the board</p> <p>焊接方法：</p> <p>(1) 预热：150° C 90-120秒</p> <p>(2) 最高焊接温度：260° C Max 5s</p> <p>(3) 浸入深度：PCB表面</p> 
5.9	Resistance to Flux 抗焊剂能力	Flux shall not be sisen up to contact, The switch shall be free from abnormalities in operation 焊剂不得上升进入开关内部，影响接触转换 试件在操作过程中不应发生变形	<p>The switch is tested under the following parameters:</p> <p>(1) Equipment: automatic welding machine</p> <p>(2) Solder: General</p> <p>(3) Flux: a colorless transparent solution of 25% rosin and 75% methanol</p> <p>(4) Welding temperature: 260 ± 5 ° C</p> <p>(5) Immersion time: 3 ± 1s</p> <p>(6) Immersion depth: the terminal shall be immersed in the root of the switch</p> <p>开关在下述参数条件下进行试验：</p> <p>(1) 设备：自动焊接机</p> <p>(2) 焊料：常规</p> <p>(3) 焊剂：焊剂质量百分比为25%松香为75%甲醇的无色透明溶液。</p> <p>(4) 焊接温度：260±5°C</p> <p>(5) 浸渍时间：3±1S</p> <p>(6) 浸渍深度：接线端应浸到开关根部处</p>



SPECIFICATION

6. Durability characteristics

No.	Item 项目	Criteria 标准	Test Method 实验方法
6.1	Mechanical Life 机械寿命	<p>After the experiment: Contact resistance: 500M Ω max Insulation resistance: 100M Ω min The operating force variation was within ± 30%. There was no dysfunction. The appearance and structure of the switch shall be free from damage</p>	<p>100,000cycles of operation shall be performed continuously at a rate of 60cycles per minute without load. 在加载按力1.5倍的负载条件下，行程高度在2MM，速度为60次/分，在寿命试验设备上连续转换100,000次</p>
6.2	Electronics Life 电气寿命	<p>实验后： 接触电阻：500mΩMax. 绝缘电阻:100MΩMin. 操作力衰变应在±30%以内。 无功能性不良。 开关外观及结构应无损坏</p>	<p>Under the following load conditions, the speed is 60 times / min, and the continuous conversion is 100000 times on the life test equipment DC6V 50mA 在带以下负荷的条件下，速度为60次/分 在寿命试验设备上连续转换100,000次 DC6V 50mA</p>

7、 极限电气性能：

ENVIRONMENTAL SPECIFICATION

NO.	项目 ITEM	试验条件 TEST CONDITIONS	要求 REQUIREMENTS
7.1	低温测试 Resistance to low temperature	<p>样品应按照以下实验条件进行测试，实验后样品应放在常温及标准湿度的环境中1小时后做性能测试： Following the test set forth below the sample shall be left in normal temperature and humidity conditions for 1 h before measurements are made: (1) 温度：-30±2℃ Temperature : -30±2℃ (2) 时间：96h Time: 96h</p>	<p>接触电阻：≤500mΩ Contact resistance: ≤ 500mΩ 项目3,4 Item 3,4</p>
7.2	高温测试 Heat resistance	<p>样品应按照以下实验条件进行测试，实验后样品应放在常温及标准湿度的环境中1小时后做性能测试： Following the test set forth below the sample shall be left in normal temperature and humidity conditions for 1 h before measurements are made: (1) 温度：80±2℃ temperature:80±2℃ (2) 时间：96h time: 96h</p>	

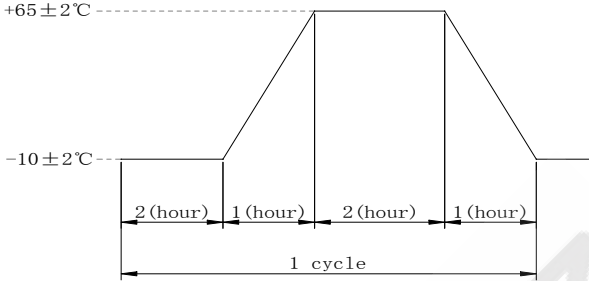

SPECIFICATION

7.3	<p>温度转换 Change of temperature</p>	<p>根据下面的测试要求进行5次循环的温度周期性测试，实验后样品应放在常温及标准湿度的环境中1小时后做性能测试。测试期间样品应保持干燥。 After 5 cycles of following conditions, the sample shall be allowed to stand under normal temperature and humidity conditions for 1 h. and measurements shall be made. During the test water drops shall be removed.</p> 	
7.4	<p>湿温测试 Moisture resistance</p>	<p>样品应按照以下实验条件进行测试，实验后样品应放在常温及标准湿度的环境中1小时后做性能测试： Following the test set forth below the sample shall be left in normal temperature and humidity conditions for 1 h before measurements are made:</p> <ul style="list-style-type: none"> (1) 温度：60±2°C temperature: 60±2°C (2) 相对湿度：90%~95% relative humidity:90% to 95% (3) 时间：96h time: 96h 	<p>接触电阻：≤500mΩ Contact resistance: ≤500mΩ 项目3, 4 Item 3, 4</p>
7.5	<p>盐雾试验 Salt Mist (铁材质不做盐雾要求)</p>	<p>在以下设定条件下进行测量： The switch shall be checked after following test:</p> <ul style="list-style-type: none"> (1) 温度：35°C±2°C temperature: 35°C±2°C (2) 盐溶液浓度：5±1%（质量百分比） salt solution : 5±1%(solids by mass) (3) 时间：24h Time: 24h <p>实验后的盐沉积物后水冲掉 After test, salt deposit shall be removed by running water.</p>	<p>金属件上没有腐蚀斑点 No remarkable corrosion shall be recognized in metal part.</p>