

1. Features

- $R_{DS(on)}=3.5m\Omega$ (typ.) @ $V_{GS}=10V$
- 100% avalanche tested
- Reliable and rugged
- Lead free and green device available (RoHS Compliant)

2. Applications

- Switching application
- Power management for inverter systems
- UPS

3.Symbol

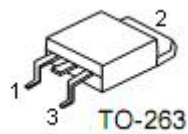
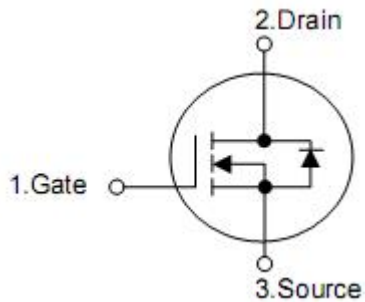

Pin	Function
1	Gate
2	Drain
3	Source

4. Ordering Information

Part Number	Package	Brand
KNB2806A	TO-263	KIA

5. Absolute maximum ratings

($T_A=25^{\circ}\text{C}$, unless otherwise noted)

Parameter		Symbol	Rating	Units	
Drain-source voltage		V_{DSS}	60	V	
Gate-source voltage		V_{GSS}	± 25	V	
Maximum junction temperature		T_J	175	$^{\circ}\text{C}$	
Storage temperature range		T_{STG}	-55 to 175	$^{\circ}\text{C}$	
Diode continuous forward current	$T_C=25^{\circ}\text{C}$	I_S	150	A	
Continuous drain current	$T_C=25^{\circ}\text{C}$	I_D^3	150	A	
	$T_C=100^{\circ}\text{C}$		105	A	
Pulse drain current*	$T_C=25^{\circ}\text{C}$	I_{DM}^4	580	A	
Avalanche energy, single pulsed		$L=1\text{mH}$	E_{AS}^5	1200	mJ
Maximum power dissipation	$T_C=25^{\circ}\text{C}$	P_D	230	W	
	$T_C=100^{\circ}\text{C}$		115		

6. Thermal characteristics

Parameter	Symbol	Rating	Unit
Thermal resistance, Junction-ambient	$R_{\theta JA}$	62.5	$^{\circ}\text{C}/\text{W}$
Thermal resistance, Junction-case	$R_{\theta JC}$	0.65	$^{\circ}\text{C}/\text{W}$

7. Electrical characteristics

(T_A=25°C, unless otherwise noted)

Parameter	Symbol	Test Conditions	Min	Typ	Max	Units
Drain-source breakdown voltage	BV _{DSS}	V _{GS} =0V, I _{DS} =250μA	60	-	-	V
Zero gate voltage drain current	I _{DSS}	V _{DS} =48V, V _{GS} =0V T _J =85°C	-	-	1	μA
			-	-	10	
Gate threshold voltage	V _{GS(th)}	V _{DS} =V _{GS} , I _D =250μA	2.0	3.0	4.0	V
Gate leakage current	I _{GSS}	V _{GS} =±25V, V _{DS} =0V	-	-	±100	nA
Drain-source on-state resistance	R _{DS(on)} ¹	V _{GS} =10V, I _D =60A	-	3.5	4.5	mΩ
Gate resistance	R _g	V _{DS} =0V, V _{GS} =0V, f=1MHz	-	0.7	-	Ω
Diode forward voltage	V _{SD} ¹	I _{SD} =60A, V _{GS} =0V	-	0.8	1.2	V
Reverse recovery time ²	t _{rr}	I _F =60A, V _{DD} =50V dI _{SD} /dt=100A/μs	-	30	-	nS
Reverse recovery charge ²	Q _{rr}		-	50	-	nC
Input capacitance ²	C _{iss}	V _{DS} =25V, V _{GS} =0V, f=1MHz	-	4376	-	pF
Output capacitance ²	C _{oss}		-	857	-	
Reverse transfer capacitance ²	C _{rss}		-	334	-	
Turn-on delay time ²	t _{d(on)}	V _{DD} =30V, I _{DS} =60A, R _G =25Ω, V _{GS} =10V	-	28	-	ns
Rise time ²	t _r		-	18	-	
Turn-off delay time ²	t _{d(off)}		-	42	-	
Fall time ²	t _f		-	54	-	
Total gate charge ²	Q _g	V _{DS} =48V, V _{GS} =10V I _{DS} =60A	-	130	-	nC
Gate-source charge ²	Q _{gs}		-	24	--	
Gate-drain charge ²	Q _{gd}		-	47	--	

Note: 1: Pulse test; pulse width ≤ 300μs duty cycle ≤ 2%.

2: Guaranteed by design, not subject to production testing.

3: Package limitation current is 75A, Calculated continuous current based on maximum allowable junction temperature.

4: Repetitive rating, pulse width limited by junction temperature.

5: Starting T_J=25°C, L=1mH.

8. Test circuits and waveforms

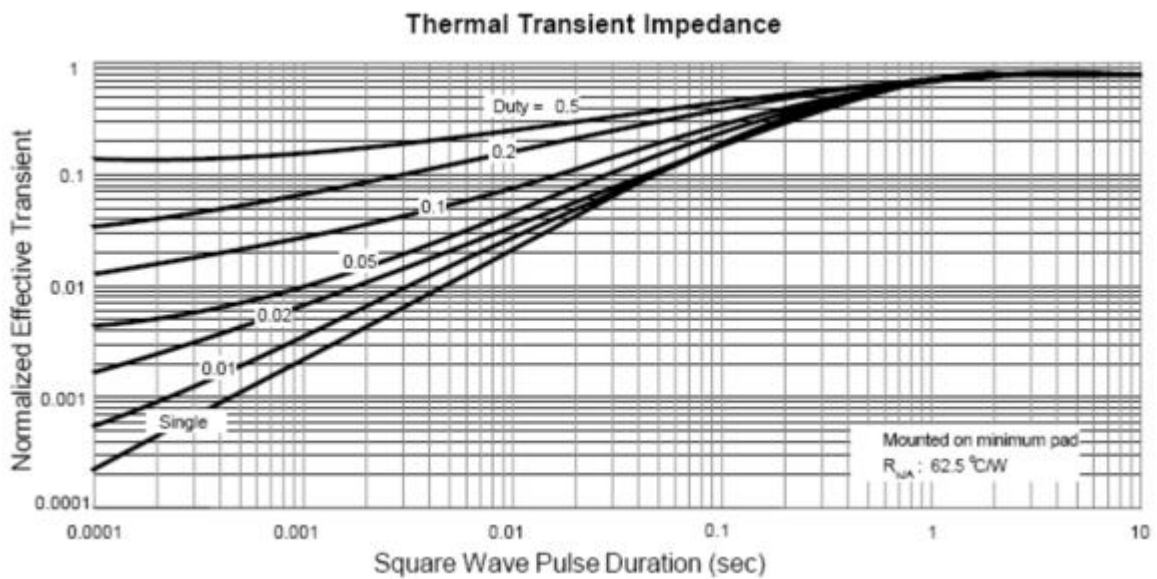
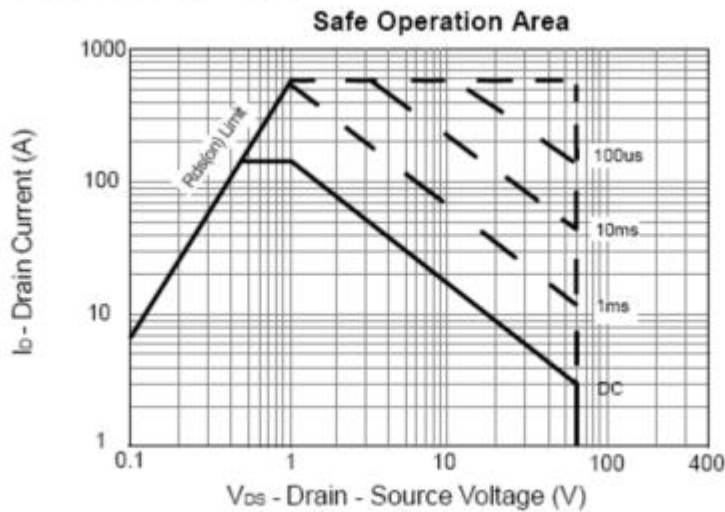
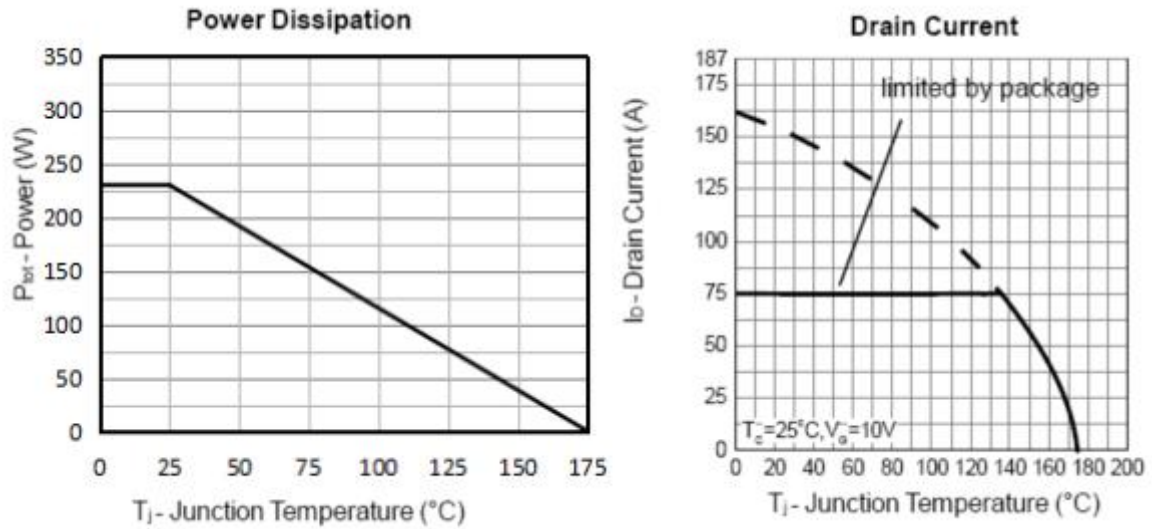

Output Characteristics

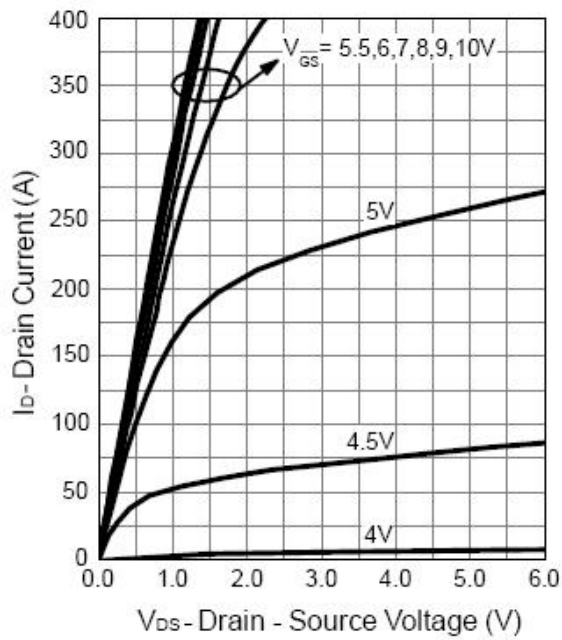

Drain-Source On Resistance

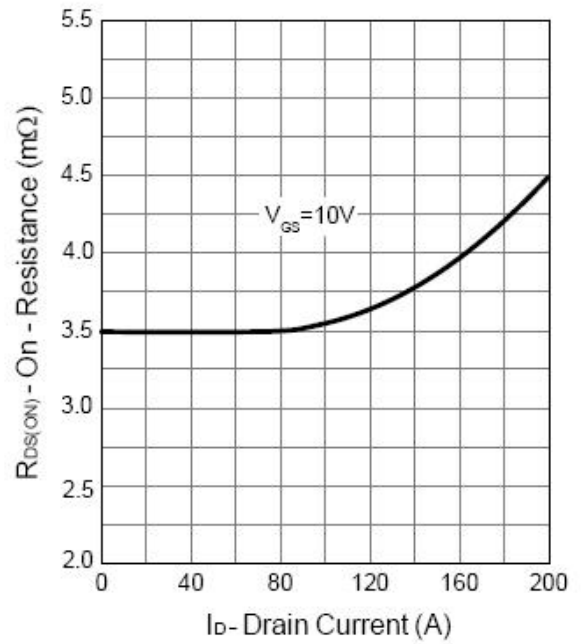

Gate-Source On Resistance

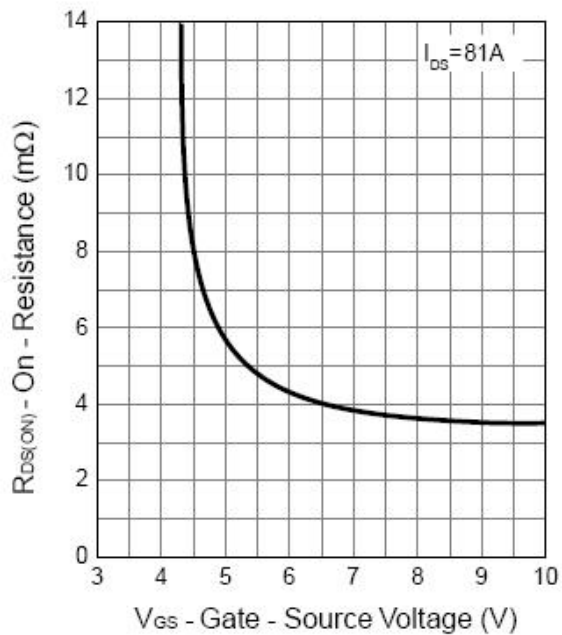

Gate Threshold Voltage

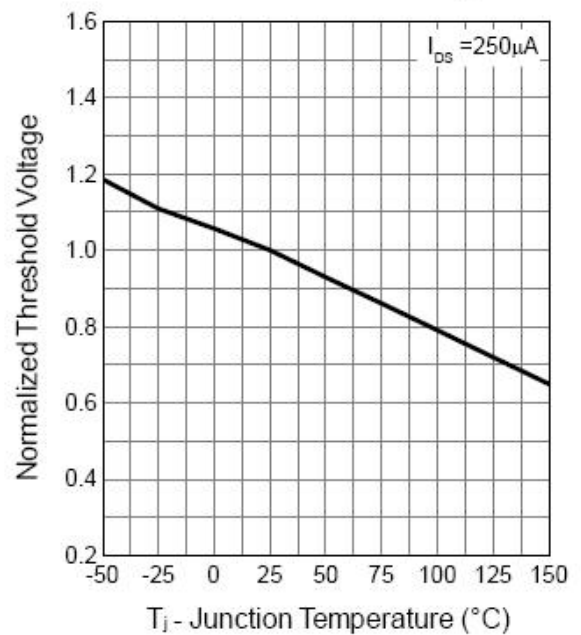

Drain-Source On Resistance

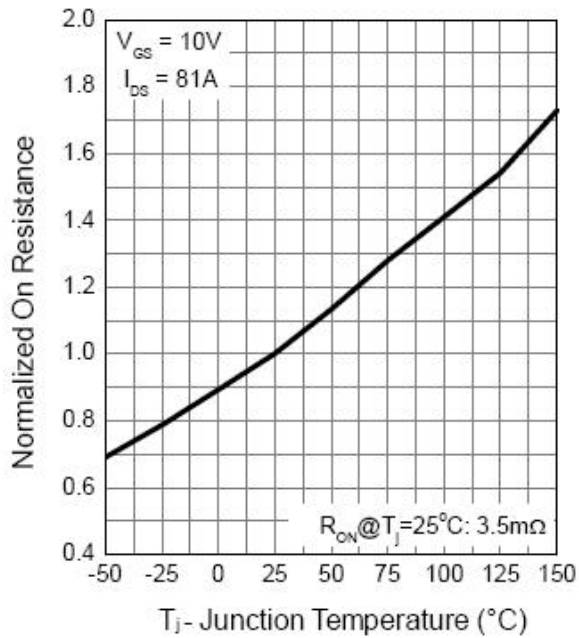

Source-Drain Diode Forward

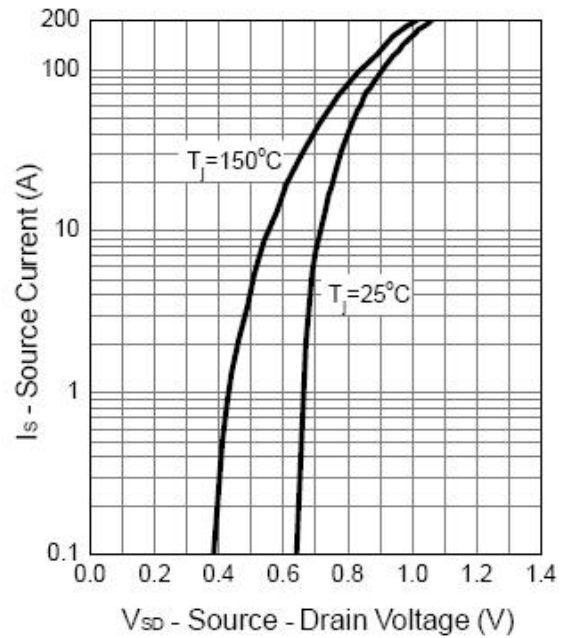

Capacitance

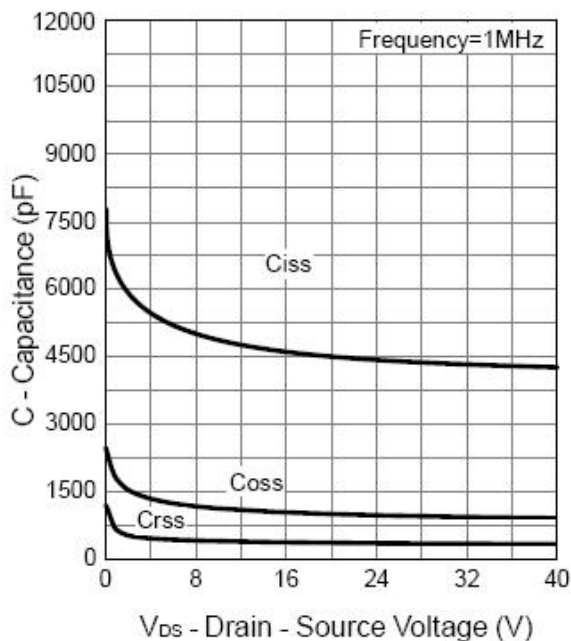

Gate Charge

