

### General Description

These P-Channel enhancement mode power field effect transistors are using trench DMOS technology. This advanced technology has been especially tailored to minimize on-state resistance, provide superior switching performance, and withstand high energy pulse in the avalanche and commutation mode. These devices are well suited for high efficiency fast switching applications.

### SOT23-3S Pin Configuration

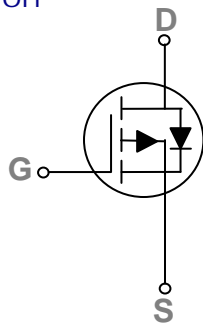
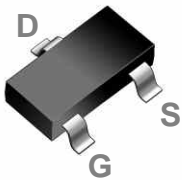

BVDSS	RDSON	ID
-20V	33mΩ	-5.8A

### Features

- -20V,-5.8A,  $R_{DS(ON)} = 33m\Omega @ V_{GS} = -4.5V$
- Improved  $dv/dt$  capability
- Fast switching
- Green Device Available
- Suit for -1.8V Gate Drive Applications

### Applications

- Notebook
- Load Switch
- Battery Protection
- Hand-held Instruments

### Absolute Maximum Ratings $T_c=25^\circ\text{C}$ unless otherwise noted

Symbol	Parameter	Rating	Units
$V_{DS}$	Drain-Source Voltage	-20	V
$V_{GS}$	Gate-Source Voltage	$\pm 10$	V
$I_D$	Drain Current – Continuous ( $T_c=25^\circ\text{C}$ )	-5.8	A
	Drain Current – Continuous ( $T_c=100^\circ\text{C}$ )	-3.7	A
$I_{DM}$	Drain Current – Pulsed <sup>1</sup>	-23.2	A
$P_D$	Power Dissipation ( $T_c=25^\circ\text{C}$ )	1.56	W
	Power Dissipation – Derate above $25^\circ\text{C}$	0.012	W/ $^\circ\text{C}$
$T_{STG}$	Storage Temperature Range	-55 to 150	$^\circ\text{C}$
$T_J$	Operating Junction Temperature Range	-55 to 150	$^\circ\text{C}$

### Thermal Characteristics

Symbol	Parameter	Typ.	Max.	Unit
$R_{\theta JA}$	Thermal Resistance Junction to ambient	---	80	$^\circ\text{C/W}$

**Electrical Characteristics ( $T_J=25\text{ }^\circ\text{C}$ , unless otherwise noted)**
**Off Characteristics**

Symbol	Parameter	Conditions	Min.	Typ.	Max.	Unit
$BV_{DSS}$	Drain-Source Breakdown Voltage	$V_{GS}=0V, I_D=-250\mu A$	-20	---	---	V
$\Delta BV_{DSS}/\Delta T_J$	$BV_{DSS}$ Temperature Coefficient	Reference to $25\text{ }^\circ\text{C}$ , $I_D=-1mA$	---	-0.02	---	$V/^\circ\text{C}$
$I_{DSS}$	Drain-Source Leakage Current	$V_{DS}=-20V, V_{GS}=0V, T_J=25\text{ }^\circ\text{C}$	---	---	-1	$\mu A$
		$V_{DS}=-16V, V_{GS}=0V, T_J=125\text{ }^\circ\text{C}$	---	---	-10	$\mu A$
$I_{GSS}$	Gate-Source Leakage Current	$V_{GS}=\pm 10V, V_{DS}=0V$	---	---	$\pm 100$	nA

**On Characteristics**

$R_{DS(ON)}$	Static Drain-Source On-Resistance	$V_{GS}=-4.5V, I_D=-4A$	---	28	33	m $\Omega$
		$V_{GS}=-2.5V, I_D=-3A$	---	37	45	
		$V_{GS}=-1.8V, I_D=-2A$	---	49	65	
$V_{GS(th)}$	Gate Threshold Voltage	$V_{GS}=V_{DS}, I_D=-250\mu A$	-0.3	-0.6	-1	V
$\Delta V_{GS(th)}$	$V_{GS(th)}$ Temperature Coefficient		---	2	---	$mV/^\circ\text{C}$
gfs	Forward Transconductance	$V_{DS}=-10V, I_S=-3A$	---	8.4	---	S

**Dynamic and switching Characteristics**

$Q_g$	Total Gate Charge <sup>2,3</sup>	$V_{DS}=-10V, V_{GS}=-4.5V, I_D=-4A$	---	16.1	25	nC
$Q_{gs}$	Gate-Source Charge <sup>2,3</sup>		---	1.8	3	
$Q_{gd}$	Gate-Drain Charge <sup>2,3</sup>		---	3.8	7	
$T_{d(on)}$	Turn-On Delay Time <sup>2,3</sup>	$V_{DD}=-10V, V_{GS}=-4.5V, R_G=25\Omega$ $I_D=-1A$	---	8.2	16	nS
$T_r$	Rise Time <sup>2,3</sup>		---	30	57	
$T_{d(off)}$	Turn-Off Delay Time <sup>2,3</sup>		---	71.1	135	
$T_f$	Fall Time <sup>2,3</sup>		---	19.8	38	
$C_{iss}$	Input Capacitance	$V_{DS}=-15V, V_{GS}=0V, F=1MHz$	---	1440	2100	pF
$C_{oss}$	Output Capacitance		---	155	230	
$C_{rss}$	Reverse Transfer Capacitance		---	115	170	

**Drain-Source Diode Characteristics and Maximum Ratings**

Symbol	Parameter	Conditions	Min.	Typ.	Max.	Unit
$I_S$	Continuous Source Current	$V_G=V_D=0V$ , Force Current	---	---	-5.8	A
$I_{SM}$	Pulsed Source Current		---	---	-23.2	A
$V_{SD}$	Diode Forward Voltage	$V_{GS}=0V, I_S=-1A, T_J=25\text{ }^\circ\text{C}$	---	---	-1	V

Note :

1. Repetitive Rating : Pulsed width limited by maximum junction temperature.
2. The data tested by pulsed , pulse width  $\leq 300\mu s$ , duty cycle  $\leq 2\%$ .
3. Essentially independent of operating temperature.

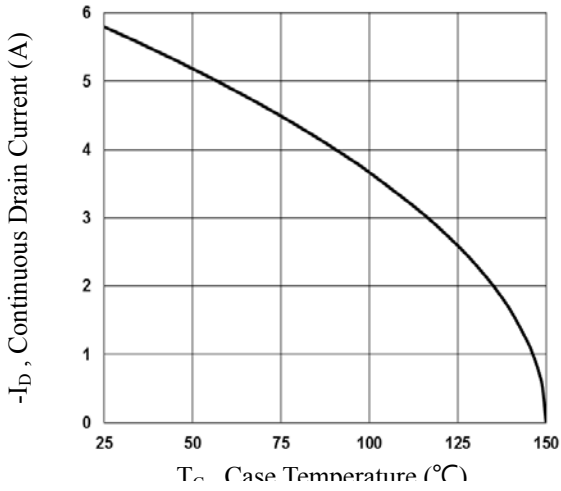

Fig.1 Continuous Drain Current vs.  $T_c$

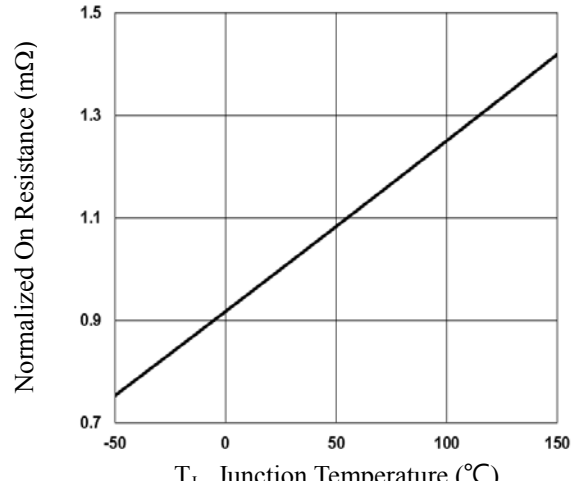

Fig.2 Normalized  $R_{DS(on)}$  vs.  $T_j$

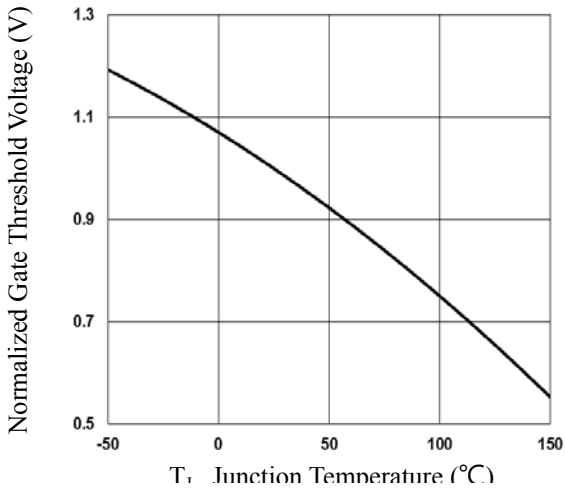

Fig.3 Normalized  $V_{th}$  vs.  $T_j$

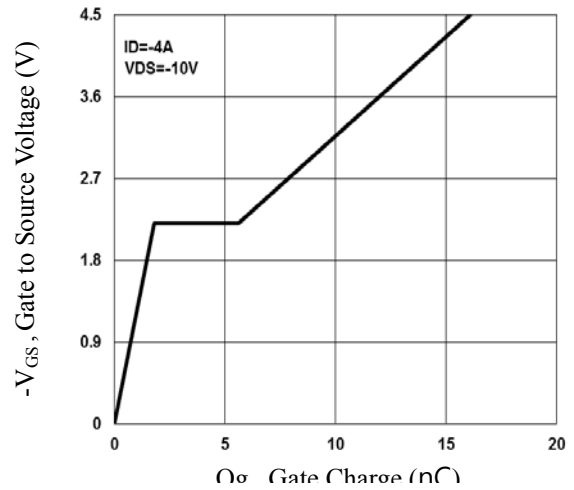

Fig.4 Gate Charge Waveform

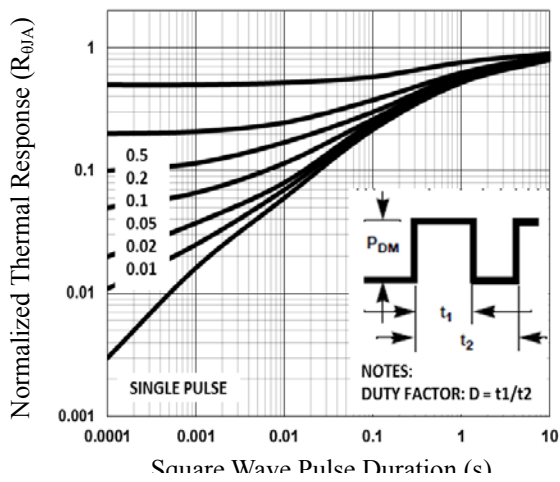

Fig.5 Normalized Transient Impedance

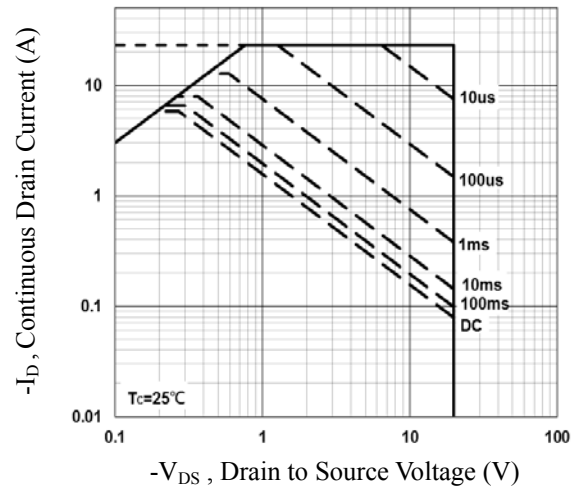

Fig.6 Maximum Safe Operation Area

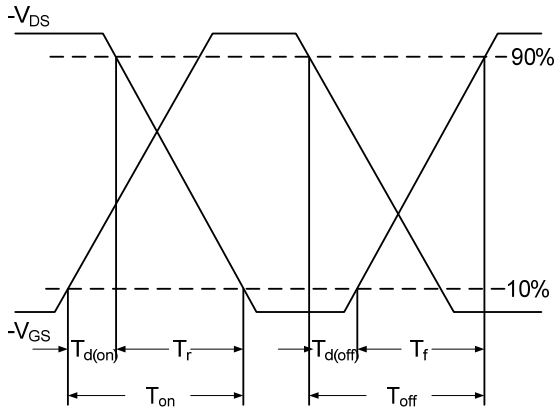

Fig.7 Switching Time Waveform

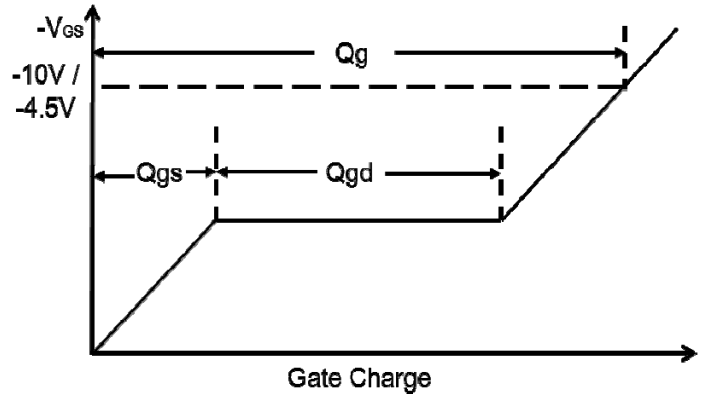
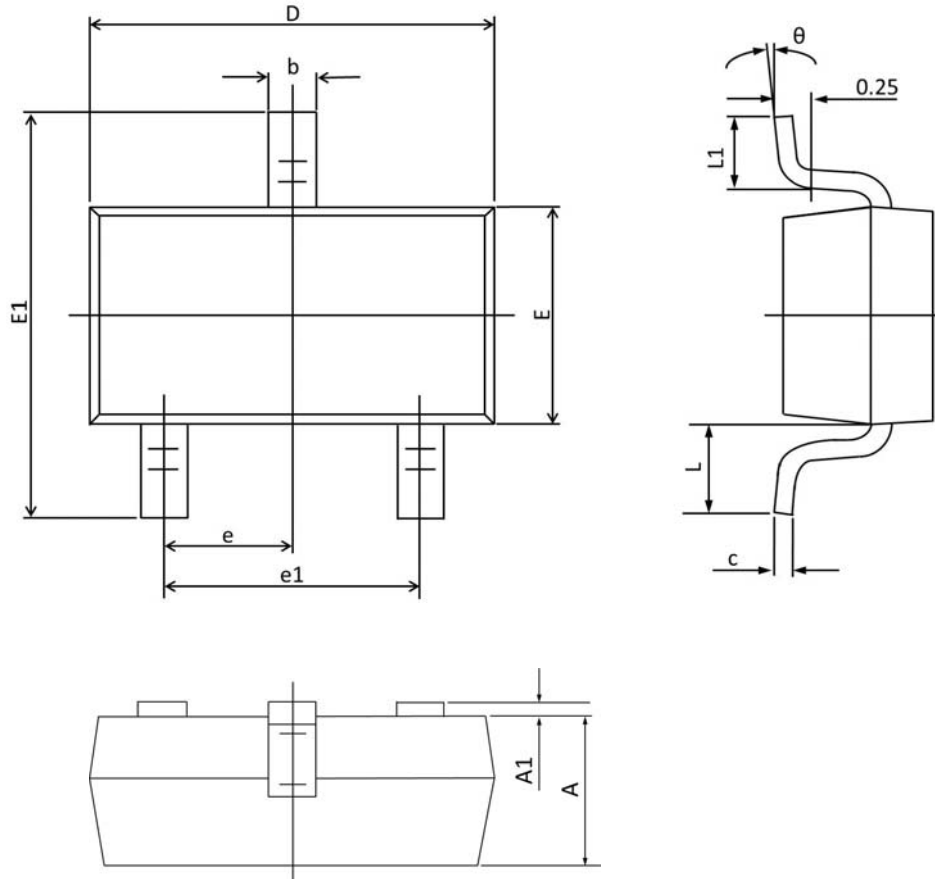

Fig.8 Gate Charge Waveform

### SOT23-3S PACKAGE INFORMATION



Symbol	Dimensions In Millimeters		Dimensions In Inches	
	Min	Max	Min	Max
A	0.900	1.000	0.035	0.039
A1	0.000	0.100	0.000	0.004
b	0.300	0.500	0.012	0.020
c	0.090	0.110	0.003	0.004
D	2.800	3.000	0.110	0.118
E	1.200	1.400	0.047	0.055
E1	2.250	2.550	0.089	0.100
e	0.950 TYP.		0.037 TYP.	
e1	1.800	2.000	0.071	0.079
L	0.550 REF.		0.022 REF.	
L1	0.300	0.500	0.012	0.020
θ	1°	7°	1°	7°