

| | | |
|-----------|---|------------------------|
| CLASS No. | TITLE 回転形エンコーダ 規格書 ROTATIONAL ENCODER SPECIFICATION | EC11E1564454 (SW01) |
|-----------|---|------------------------|

1. 一般事項 General

1-1 適用範囲 Scope

この仕様書は主として電子機器に用いる微小電流回路用11形薄形ロータリーエンコーダに適用する。
This specification applies to 11mm size low-profile rotary encoder (incremental type) for microscopic current circuits, used in electronic equipment.

1-2 標準状態 Standard atmospheric conditions

測定は特に指定のない限り、次の状態で行なう。
Unless otherwise specified, the standard range of atmospheric conditions for making measurements and tests is as follows:

温度 Ambient temperature : 15°C to 35°C
 相対湿度 Relative humidity : 25% to 85%
 気圧 Air pressure : 86kPa to 106kPa

但し、疑義を生じた場合は、次の基準状態で行なう。

If there is any doubt about the results, measurements shall be made within the following limits:

温度 Ambient temperature : 20 ± 1°C
 相対湿度 Relative humidity : 63% to 67%
 気圧 Air pressure : 86kPa to 106kPa

1-3 使用温度範囲

Operating temperature range : -40°C to +85°C

1-4 保存温度範囲

Storage temperature range : -40°C to +85°C

2. 構造 Construction

2-1 寸法 Dimensions

添付組立図による。
Refer to attached drawing.

3. 定格 Rating

3-1 定格容量 Rating : D.C. 5V 10mA (1mA MIN)

4. 電気的性能 Electrical characteristics

| 項目 Item | 条件 Conditions | 規格 Specifications | |
|----------------------------------|-------------------------------------|------------------------------|-----------------|
| 4-1 出力信号 Output signal format | <Fig 1> | | |
| | 軸回転方向 Shaft rotational direction | 信号 Signal | |
| | 時計方向 C. W. | A(A-C端子間) A(Terminal A-C) | 出力波形状 Output |
| | | B(B-C端子間) B(Terminal B-C) | |
| 反時計方向 C. C. W. | A(A-C端子間) A(Terminal A-C) | | |
| | B(B-C端子間) B(Terminal B-C) | | |

EC11E15
15P/30C

ALPS ELECTRIC CO., LTD.

| | | | |
|-----------------------------|-----------------------------|--------------------------------|---|
| APPD 承認 05.2.23 相沢 | CHKD 確認 05.2.23 木村 | DSGD 添設計検作 05.2.22 清水 | TITLE 回転形エンコーダ ROTATIONAL ENCODER |
| SYMB | DATE | APPD | CHKD |
| | | | DSGD |
| DOCUMENT NO. | | | 5LA211-E247 (1/4) |

| | | |
|-----------|---|--------|
| CLASS No. | TITLE 回転形エンコーダ* 規格書 ROTATIONALENCODER SPECIFICATION | (SW01) |
|-----------|---|--------|

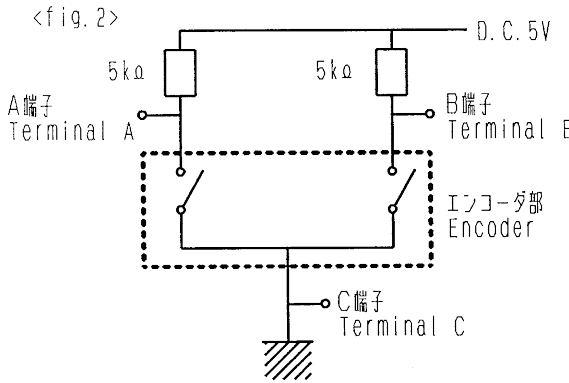
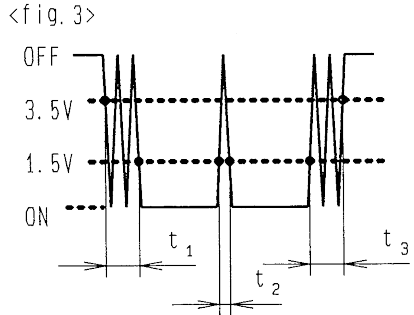
| 項目 item | 条件 Conditions | 規格 Specifications |
|---|--|---|
| 4-2 分解能 Resolution | 1回転にて出力されるパルス数 Number of pulses in 360° rotation. | 各相15パルス/360° 15 pulses/360° for each phase (2クリック 1パルス) (2click 1pulse) |
| 4-3 スイッチング特性 Switching characteristics | <p>下記測定回路<fig. 2>を用い、回転軸を$360^{\circ} \cdot s^{-1}$の速さで回転し測定する。 Measurement shall be made under the condition as follows. 1) Shaft rotational speed : $360^{\circ} \cdot s^{-1}$ 2) Test circuit : <fig. 2></p>  <p><fig. 2></p>  <p><fig. 3></p> <p>(注記) コードOFF状態 : 出力電圧が3.5V以上の状態を言う。 コードON状態 : 出力電圧が1.5V以下の状態を言う。 (note) Code-OFF area : The area which the voltage is 3.5V or more. code-ON area : The area which the voltage is 1.5V or less.</p> | |
| 1) チャタリング Chattering | コードのOFF→ON及びON→OFFの際の、出力1.5V~3.5Vの通過時間にて規定する。 Specified by the signal's passage time from 3.5V to 1.5V or from 1.5V to 3.5V of each switching position (code OFF→ON or ON→OFF). | $t_1, t_3 \leq 3ms$ |
| 2) 摺動ノイズ (バウンス) Sliding noise (Bounce) | コードONの部分の1.5V以上の電圧変動時間とし、チャタリング t_1, t_3 両者との間に1ms以上の1.5V以下のON部分を有するものとする。また、摺動ノイズ間に1.5V以下の範囲が1msある場合は、別の摺動ノイズと判断する。 Specified by the time of voltage change exceed 1.5V in code-ON area. When the bounce has code-ON time less than 1ms between chatterings (t_1 or t_3), the voltage change shall be regarded as a part of chattering. When the code-ON time between 2 bounces is less than 1ms, they are regarded as 1 linked bounce. | $t_2 \leq 2ms$ |
| 3) 摺動ノイズ Sliding noise | コードOFFの部分の電圧変動 The voltage change in code-OFF area. | 3.5V以上 3.5V MIN |

ALPS ELECTRIC CO., LTD.

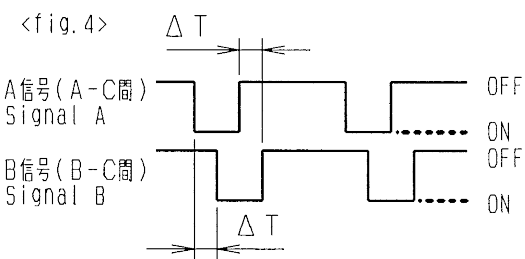

| | | | | | |
|---------------------------------|---------------------------------|----------------------------------|---|------|-----------------------------------|
| APPD. 承認 '05. 2. 23 相沢 | CHKD. 設計 '05. 2. 23 木村 | DSGD. 通設計 '05. 2. 22 清水 | TITLE 回転形エンコーダ ROTATIONAL ENCODER | | |
| SYMB | DATE | APPD | CHKD | DSGD | DOCUMENT NO. 5LA211-E247 (2/4) |

| CLASS No. | TITLE | | |
|---|---|---|--------|
| | 回転形エンコーダ 規格書 ROTATIONALENCODER SPECIFICATION | | (SW01) |
| 項目 Item | 条件 Conditions | 規格 Specifications | |
| 4-4 位相差 Phase-difference | <p>360°・s⁻¹の定速にて操作軸を回転する。 Measurement shall be made under the condition which the shaft is rotated in 360°・s⁻¹ (constant speed).</p> <p><fig. 4></p>  | <p><fig. 4>において ΔT≥6ms In<fig. 4></p> | |
| <p>注意事項：撥動接点ですので手動操作時の出力波形はご使用されるツマミ径、軸の回転速度によって変化致します。回路設計時は実装にて確認願います。 Note: Above specification (4-4) is changeable. When operate by manual. Please check performance using actual circuit and knob.</p> | | | |
| 4-5 絶縁抵抗 Insulation resistance | 端子-軸受間にD. C. 250V印加する。 Measurement shall be made under the condition which a voltage of 250V D.C. is applied between individual terminals and bushing. | 端子-軸受間にて100MΩ以上 Between individual terminals and bushing: 100MΩ MIN. | |
| 4-6 耐電圧 Dielectric strength | 端子-軸受間にA. C. 300V1分間又は、A. C. 360V2秒間印加する。 (リーク電流1mA) A voltage of 300V A.C. shall be applied for 1min or a voltage of 360V A.C. shall be applied for 2s between individual terminals and bushing. (Leak current:1mA) | 損傷・アーク・絶縁破壊がないこと。 Without damage to parts, arcing or breakdown. | |

5. 機械的性能 Mechanical characteristics

| 項目 Item | 条件 Conditions | 規格 Specifications | |
|---|--|--|--|
| 5-1 全回転角度 Total rotational angle | | 360° (エンドレス) 360° (Endless) | |
| 5-2 クリックトルク Detent torque | | 15±7mN・m | |
| 5-3 クリック点数及び位置 Number and position of detents. | | 30点クリック 30 detents (ステップ角度 12°±3°) (Step angle: 12°±3°) | |
| 5-4 端子強度 Terminal strength | 端子先端の任意の方向に5Nの力を1分間加える。 A static load of 5N be applied to the tip of terminals for 1min in any direction. | 端子の破損、著しい力ぐたがないこと。 但し、端子の曲がりは可とする。 Without damage or excessive looseness of terminals. Terminal bend is permitted. | |

ALPS ELECTRIC CO., LTD.

| | | | |
|---|---|---|-------------------------------|
| APPD. | CHKD. | DSGD. | TITLE |
|  |  |  | 回転形エンコーダ ROTATIONALENCODER |
| DATE | APPD. | CHKD. | DSGD. |
| | | | |
| DOCUMENT NO. | | | 5LA211-E247 (3/4) |

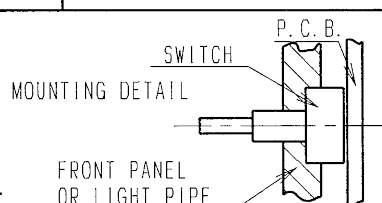

| | | |
|-----------|--|--------|
| CLASS NO. | 回転形エンコーダ 規格書 ROTATIONAL ENCODER SPECIFICATION | (SW01) |
|-----------|--|--------|

| 項目 Item | 条件 Conditions | 規格 Specifications | | | | | | | | | | | | |
|--|--|---|-------------------------------|------------------------------------|---|----------|---|----------|----|----------|------|----------|----|-----------|
| 5-4 軸の押し引き強度 Push-pull strength of shaft | 軸の押し及び引張り方向に100Nの力を10秒間加える。 (セット実装状態) Push and pull static load of 100N shall be applied to the shaft in the axial direction for 10s. (After installing) | 軸の破損、著しいカタのないこと。 感触に異常がないこと。 Without damage or excessive play in shaft. No excessive abnormality in rotational feeling. | | | | | | | | | | | | |
| 5-5 軸カタ Shaft wobble | 取付面より30mmの位置に50mN・mの曲げモーメントを加える。 軸長が30mmに満たない場合は右の式による。Lは測定位置(取付面からの位置)とする。 Bending moment of 50mN・m to be applied to the shaft at 30mm from the mounting surface. If the shaft length is less than 30mm, the value shall be calculated as right formula. L: Measurement point from mounting surface. | <table style="width: 100%; border-collapse: collapse;"> <tr> <td style="text-align: center;">軸受長 Bushing length (mm)</td> <td style="text-align: center;">軸カタ Wobble 以下 (mm-p less)</td> </tr> <tr> <td style="text-align: center;">5</td> <td style="text-align: center;">0.8xL/30</td> </tr> <tr> <td style="text-align: center;">7</td> <td style="text-align: center;">0.5xL/30</td> </tr> <tr> <td style="text-align: center;">10</td> <td style="text-align: center;">0.4xL/30</td> </tr> <tr> <td style="text-align: center;">15.5</td> <td style="text-align: center;">0.3xL/30</td> </tr> <tr> <td style="text-align: center;">20</td> <td style="text-align: center;">0.25xL/30</td> </tr> </table> | 軸受長 Bushing length (mm) | 軸カタ Wobble 以下 (mm-p less) | 5 | 0.8xL/30 | 7 | 0.5xL/30 | 10 | 0.4xL/30 | 15.5 | 0.3xL/30 | 20 | 0.25xL/30 |
| 軸受長 Bushing length (mm) | 軸カタ Wobble 以下 (mm-p less) | | | | | | | | | | | | | |
| 5 | 0.8xL/30 | | | | | | | | | | | | | |
| 7 | 0.5xL/30 | | | | | | | | | | | | | |
| 10 | 0.4xL/30 | | | | | | | | | | | | | |
| 15.5 | 0.3xL/30 | | | | | | | | | | | | | |
| 20 | 0.25xL/30 | | | | | | | | | | | | | |
| 5-6 軸のスラスト方向カタ Shaft play in axial direction | | 0.4mm以下 0.4mm MAX. | | | | | | | | | | | | |
| 5-7 軸の回転方向カタ Rotation play at the click position | 角度板にて測定する。 Measure with jig for rotational angle. | 4°以内 4° MAX. | | | | | | | | | | | | |
| 5-8 取付け上の注意 Notice for mounting | 右図の様にスイッチ本体を挿えてご使用下さい。セット側でスイッチ本体の引き及び回転方向のカタが無い場合は、ほんだ付けだけの固定となり、ほんだ付け信頼性及びスイッチ本体強度が不安定となる可能性があります。 Hold the bushing use front panel or light pipe. Because this switch not has thread. If don't hold the bushing, the switch maybe become intermittent rough mounting after soldering by knob stopper force. |  | | | | | | | | | | | | |

6. 耐久性能 Endurance characteristics.

| 項目 Item | 条件 Conditions | 規格 Specifications |
|------------------------------------|---|---|
| 6-1 しゅう動寿命性能 Rotational life | 無負荷で軸を毎時500サイクルの速さで、15,000サイクル連続動作を行う。 但し、試験途中5,000で中間測定を行う。(1サイクルは、360°1往復) The shaft of encoder shall be rotated to 15,000 cycles at a speed of 500cycles per hour without electrical load, after which measurements shall be made. However, an interim measurement shall be made immediately after 5,000 cycles. (1 cycle: rotate 360° CCW rotate 360° CW) | クリックトルク: 初期規格値に対し ^{+10%} / _{-30%} その他、初期規格を満足すること。 Detent torque: Relative to the previously specified value. ^{+10%} / _{-30%} Except above items, specifications in clause 4.1~6 and 5.1.5.3 shall be satisfied. |

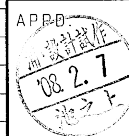
ALPS ELECTRIC CO., LTD.

| | | | |
|---|---|---|--------------------------------|
| APPR. | CHKD. | DSGD | TITLE |
|  |  |  | 回転形エンコーダ ROTATIONAL ENCODER |
| ORIG | DATE | APPD | CHKD |
| SYMB | 2005-02-23 | 相 沢 | 木 村 清 水 |
| DOCUMENT NO. | | | 5LA211-E247 (4/4) |

| | | |
|-----------|---|--------|
| CLASS No. | TITLE フッシュモーメンタリスイッチ規格書 PUSH MOMENTARY SWITCH SPECIFICATION | (SW02) |
|-----------|---|--------|

1. 定格容量 (抵抗負荷)
Switch rating (Resistor load) D.C. 5V 0.1A (MIN 500 μ A)

2. 電気的性能 Electrical characteristics

| 項目 Item | 条件 Conditions | 規格 Specifications |
|-----------------------------------|---|---|
| 2-1 接触抵抗 Contact resistance | D. C. 5V 1mA電圧降下法にて測定する。 Measured by the 1mA 5V D.C. voltage drop method. | 100m Ω MAX. |
| 2-2 チャタリング Chattering | 1サイクル (OFF-ON-OFF) 1秒で動作させる。 Switch is operated at the rate of 1 cycle 1s. The 1 cycle shall be OFF-ON-OFF. | 10ms以下 Less than 10ms |
| 2-3 絶縁抵抗 Insulation resistance | 端子-軸受間にD. C. 250V印加する。 Measurement shall be made under the condition which a voltage of 250V D.C. is applied between individual terminals and bushing. | 端子-軸受間に100M Ω 以上 Between individual terminals and bushing: 100M Ω MIN. |
| 2-4 耐電圧 Dielectric strength | 端子-軸受間にA. C. 300V1分間又は、A. C. 360V2秒間印加する。 (リーク電流1mA) A voltage of 300V A.C. shall be applied for 1min or a voltage of 360V A.C. shall be applied for 2s between individual terminals and bushing. (Leak current: 1mA) | 損傷・アーク・絶縁破壊がないこと。 Without damage to parts, arcing or breakdown. |

注記:
Note: 軸・スイッチ端子間は絶縁されております。
Shaft is insulated from switch terminal.

3. 機械的性能 Mechanical characteristics

| 項目 Item | 条件 Conditions | 規格 Specifications |
|---------------------------------------|------------------|---|
| 3-1 スイッチ回路・接点数 Contact arrangement | | 単極単投 (Push on) S. P. S. T. (Push on) |
| 3-2 スイッチ移動量 Switching stroke | | 1.5 \pm 0.5mm |
| 3-3 スイッチ作動力 Switch operation force | | 4 \pm 2N |

4. 耐久性能 Endurance characteristics.

| 項目 Item | 条件 Conditions | 規格 Specifications |
|------------------------------|--|--|
| 4-1 動作寿命特性 Operating life | 無負荷にて軸を毎時500回の速さで20,000回断続動作を行う。 但し、試験途中5,000で中間測定を行う。 The shaft of switch shall be 20,000 times at a speed of 500times per hour without electrical load, after which measurements shall be made. However, an interim measurement shall be made immediately after 5,000 times. | 接触抵抗: 200m Ω 以下 その他、初期規格を満足すること。 Switch contact resistance: 200m Ω MAX. Except above items, specifications in clause 2.2~4, and 3.1~3 shall be satisfied. |

5. その他 Note

5-1 軸にツマミを取り付け、センターから10mmの位置で押し込んだ時に引っかかり感が無いこと。
No sticky feel shall be observed when the knob on the shaft is pushed at 10mm off the center.

6. 注意事項 Note

6-1 プッシュスイッチ付きのエンコーダは、軸が押されたままの状態にて梱包や保管をされますと、スイッチ部に支障をきたす恐れがありますのでご配慮下さい。
Encoder equipped with a push-on switches are packaged or stored with their shafts being pushed-in, the switch part may be out of order and pay attention when you package or store them.

| | | | | | | | | |
|------|------|------|------|------|-----------------------------------|------|----------------------|--|
| | | | | | ALPS ELECTRIC CO., LTD. | | | |
| SYMB | DATE | APPD | CHKD | DSGD | APPD 08.2.6 清水 | CHKD | DSGD 08.2.6 清水 | TITLE フッシュモーメンタリスイッチ PUSH MOMENTARY SWITCH |
| | | | | | DOCUMENT NO. 5LA2114-E60 (1/1) | | | |

| | | |
|-----------|--|----------------|
| CLASS No. | TITLE 回転形エンコータ* 規格書 ROTATIONAL ENCODER SPECIFICATION | (SW01), (SW02) |
|-----------|--|----------------|

1. その他耐久性能 Endurance characteristics.

| 項目 Item | 条件 Conditions | 規格 Specifications |
|---|---|---|
| 1-1 高温放置試験 High temperature shelf test | 温度85±3°Cの恒温槽中に1,000±10時間放置後、常温、常湿中に1.5時間放置する。 The encoder shall be stored at a temperature of 85±3°C for 1,000±10h in a thermostatic chamber. And then the encoder shall be subjected to standard atmospheric conditions for 1.5h, after which measurements shall be made. | クリックまたは回転トルクは初期規格値に対し±30%以内のこと Detent or rotational torque: Relative to the previously specified value, ±30% MAX その他初期規格を満足すること。 Shall be meet initial specifications. |
| 1-2 高温作動試験 High temperature energizing test | 定格負荷を加え温度85±3°Cの恒温槽中に1,000±10時間放置後、常温、常湿中に1.5時間放置する。 The rated load shall be applid. The encoder shall be stored at a temperature of 85±3°C for 1,000±10h in a thermostatic chamber. And then the encoder shall be subjected to standard atmospheric conditions for 1.5h, after which measurements shall be made. | |
| 1-3 低温放置試験 Low temperature shelf test | 温度-40±3°Cの恒温槽中に1,000±10時間放置後取り出し表面の水分をふき取り常湿常湿中に1.5時間放置する。 The encoder shall be stored at a temperature of -40±3°C for 1,000±10h in a thermostatic chamber. Then the encoder shall be taken out of chamber and its surlace moisture shall be removed. And then the encoder shall be subjected to standard atmospheric conditions for 1.5h, after which measurement shall be made. | |
| 1-4 低温作動(始動)試験 Low temperature energizing test | 定格負荷を加え温度-40±3°Cの恒温槽中に1,000±10時間放置後取り出し表面の水分をふき取り常湿常湿中に1.5時間放置する。 The rated load shall be applied. The encoder shall be stored at a temperature of -40±3°C for 1,000±10h in a thermostatic chamber. Then the encoder shall be taken out of chamber and its surlace moisture shall be removed. And then the encoder shall be subjected to standard atmospheric conditions for 1.5h, after which measurment shall be made. | |
| 1-5 高温高湿保存試験 High temperature and humidity shelf test | 温度60±2°C、湿度90~95%の恒温湿槽中に1,000±10時間放置後、取り出し表面の水分をふき取り常湿常湿中に1.5時間放置後測定する。 The encoder shall be stored at a temperature of 60±2°C with relative humidity of 90% to 95% for 1,000±10h in a thermostatic chamber. Then the encoder shall be taken out of the chamber and its surface moisture shall be removed. And then the encoder shall be subjected to standard atmospheric conditions for 1.5h, after which measurement shall be made. | |
| 1-6 高温高湿通電試験 High temperature and humidity energizing test | 定格負荷を加え温度60±2°C、湿度90~95%の恒温湿槽中に1,000±10時間放置後、取り出し表面の水分をふき取り常湿常湿中に1.5時間放置後測定する。 The rated load shall be applied. The encoder shall be stored at a temperature of 60±2°C with relative humidity of 90% to 95% for 1,000±10h in a thermostatic chamber. Then the encoder shall be taken out of the chamber and its surface moisture shall be removed. And then the encoder shall be subjected to standard atmospheric conditions for 1.5h, after which measurement shall be made. | |

| | | | | | | | | |
|----------|------------|------|------|------|--------------------------------|-----------------|-----------------|----------------|
| | | | | | ALPS ELECTRIC CO., LTD. | | | |
| | | | | | APPD. M-ENG2 | CHKD. M-ENG2 | DSGD. M-ENG2 | TITLE _____ |
| | | | | | Y. KATO | A. NOMURA | M. CHIBA | DOCUMENT NO. |
| ORIGINAL | 2010-03-10 | Y. K | A. N | M. C | 2010/06/22 | 2010/06/22 | 2010/06/22 | S-E28 (1/3) |
| SYMB | DATE | APPD | CHKD | DSGD | | | | |

| CLASS No. | | TITLE 回転形エンコーダ 規格書 ROTATIONAL ENCODER SPECIFICATION | | (SW01), (SW02) | | | | | | | | | |
|-------------------------------------|--|--|--|--|-------------------|------------|---|--------|--------|---|-------|--------|--|
| 項目 Item | 条 件 Conditions | | | 規 格 Specifications | | | | | | | | | |
| 1-7 熱衝撃試験 Heat shock test | <p>下表に示した温度サイクルを連続1000回行う。表面の水分をふき取り常温常湿中に1.5時間放置後測定する。 The encoder shall be subjected to 1000 successive change of temperature cycles, each as shown in table below. Then its surface moisture shall be removed. And then the encoder shall be subjected to standard atmospheric conditions for 1.5 hour, after which measurements shall be made.</p> <table border="1"> <thead> <tr> <th>段階 Step</th> <th>温度 Temperature</th> <th>時間 Time</th> </tr> </thead> <tbody> <tr> <td>1</td> <td>-40±3℃</td> <td>30min.</td> </tr> <tr> <td>2</td> <td>85±2℃</td> <td>30min.</td> </tr> </tbody> </table> | | | 段階 Step | 温度 Temperature | 時間 Time | 1 | -40±3℃ | 30min. | 2 | 85±2℃ | 30min. | <p>クリックまたは回転トルクは初期規格値に対し±30%以内のこと Detent or rotational torque: Relative to the previously specified value. ±30% MAX 初期規格を満足すること。 Shall be meet initial specifications.</p> |
| 段階 Step | 温度 Temperature | 時間 Time | | | | | | | | | | | |
| 1 | -40±3℃ | 30min. | | | | | | | | | | | |
| 2 | 85±2℃ | 30min. | | | | | | | | | | | |
| 1-8 振動試験 Vibration test | <p>周波数 : 10Hz~500Hz~10Hz Frequency range 最大加速度 : 49.1m/s²(5G) The maximum acceletation X, Y, Z各方向8時間行う(計24時間) This motion shall be applied for a period of 8h in each of 3 mutually perpendicular axes. (A total of 24h)</p> | | | | | | | | | | | | |
| 1-9 ウィスカ試験 Whisker test | <p>条件1 Condition1 常温常湿で3000時間放置する。 The encoder shall be subjected to standard atmospheric conditions for 3000h. 条件2 Condition2 温度85℃, 湿度85%RHの恒温槽中に2000±10時間放置後取り出し常温常湿に1.5時間放置する。 The encoder shall be stored at a temperature of 85℃ with relative humidity of 85% for 2.000±10h in a thermostatic chamber. And then the encoder shall be subjected to standard atmospheric conditions for 1.5h, after which measurement shall be made. 条件3 Condition3 下記に示した温度サイクルを連続1000回行う。 The encoder shall be subjected to 1000 successive change of temperature cycles, each as shown in table below.</p> <table border="1"> <thead> <tr> <th>段階 Step</th> <th>温度 Temperature</th> <th>時間 Time</th> </tr> </thead> <tbody> <tr> <td>1</td> <td>-40±3℃</td> <td>30min.</td> </tr> <tr> <td>2</td> <td>85±2℃</td> <td>30min.</td> </tr> </tbody> </table> | | | 段階 Step | 温度 Temperature | 時間 Time | 1 | -40±3℃ | 30min. | 2 | 85±2℃ | 30min. | <p>端子上のウィスカは、最小電極間隔の1/2未満、または、長さ50um以下。 The whisker on the terminal is less than 1/2 at minimum electrode intervals or length 50um or less.</p> |
| 段階 Step | 温度 Temperature | 時間 Time | | | | | | | | | | | |
| 1 | -40±3℃ | 30min. | | | | | | | | | | | |
| 2 | 85±2℃ | 30min. | | | | | | | | | | | |
| 1-10 衝撃試験 (自由落下) Free falling | <p>50cm 100cmの高さからコンクリート上に自由落下させる。 The encoder is naturally dropped from the height of 100cm on the concrete. 条件: 3回×6方向 Condition: 3 times x 6 direction</p> | | | <p>著しい変形、破損等がなく、初期規格を満足すること。 ただし、端子部の変形は除く。 Must be or exceed the initial specifications, and get no excessive deformation or damage. Except the deformation of terminals.</p> | | | | | | | | | |

| | | | | | | | | |
|----------|------------|------|------|------|--------------------------------|------------|------------|--------------|
| | | | | | ALPS ELECTRIC CO., LTD. | | | |
| | | | | | APPD. | CHKD. | DSGD. | TITLE |
| | | | | | M-ENG2 | M-ENG2 | M-ENG2 | |
| | | | | | Y. KATO | A. NOMURA | M. CHIBA | DOCUMENT NO. |
| △ 2 | 2010-12-08 | S. M | A. N | Y. S | 2010/06/22 | 2010/06/22 | 2010/06/22 | S-E28 (2/3) |
| ORIGINAL | 2010-03-10 | Y. K | A. N | M. C | | | | |
| SYMB | DATE | APPD | CHKD | DSGD | | | | |

| | | |
|-----------|---|----------------|
| CLASS No. | TITLE 回転形エンコーダ 規格書 ROTATIONAL ENCODER SPECIFICATION | (SW01), (SW02) |
|-----------|---|----------------|

| 項目 Item | 条件 Conditions | 規格 Specifications |
|--|--|---|
| 1-11 端子強度 Terminal strength | <p>引っ張り強度 Pull strenght</p> <p>端子の引き出し軸が垂直になるように保持し、どのような衝撃も加えないように徐々に2.5Nの力を加え10±1秒間保持する。 The trial offer is maintained so that the drawing out axis of the terminal may become vertical. The power of gradually 2.5N is added so as not to add the impact, and the power is maintained for 10±1s.</p> <hr/> <p>曲げ試験 Bending test</p> <p>端子の引き出し軸が垂直になるように保持し、端子先端に1.25Nのおもりをつり下げ、本体を90°曲げた後、元の位置に戻す。操作は2~3秒間で行い、これを1回とする。次に逆方向に同じ速さで90°曲げ、再び元の位置に戻す。 After the trial is maintained so that the drawing out axis of the terminal may become vertical, the harpoon 1.25N is hung on the point of the terminal, and the main body is bent by 90°, it returns it to former position. The operation makes this do in 2-3 seconds once. next, 90° in the same speed as the opposite direction is bent, and returns it to former position again.</p> <hr/> <p>ねじり試験 Twist test</p> <p>端子を90°折曲げて固定し、スイッチ本体を5秒間で360°回転させる。交互回転方向を1セットとし、2回行なう。 The terminal is bent to 90 degrees it fixes, and the encoder body is rotated by 360 degrees every five seconds. 360 degrees are made to be rotated by one round trip 1 time, and it dose 2 times.</p> | <p>(SW01), (SW02)</p> <p>初期規格を満足し、外觀及び構造に異常が無い事。 Meet an initial standard, and do not find abnormality in extemals and the structure. The transformation of the terminal is excluded.</p> |
| 1-12 ガス腐食試験 Gaseous corrosion test | <p>無負荷で、H₂S濃度10ppm、温度40±2°C、湿度80%RHの槽中に240時間放置する。 The encoder shall be stored at a H₂s density of 10ppm, with temperature of 40±2°C, relative humidity of 80% RH for 240 hours in a thermostatic chamber without load.</p> | <p>(SW01) 摺動ノイズは初期規格値の2倍以下。 Sliding noise: twice or less initial spec.</p> <p>(SW02) 接触抵抗：初期規格値の2倍以下 Contact resistance: twice or less initial spec.</p> |

| | | | | | | | | |
|----------|------------|------|------|------|--------------------------------|-----------------|-----------------|--------------|
| | | | | | ALPS ELECTRIC CO., LTD. | | | |
| | | | | | APPD. M-ENG2 | CHKD. M-ENG2 | DSGD. M-ENG2 | TITLE |
| | | | | | Y. KATO | A. NOMURA | M. CHIBA | DOCUMENT NO. |
| ORIGINAL | 2010-03-10 | Y. K | A. N | M. C | 2010/06/22 | 2010/06/22 | 2010/06/22 | S-E28 (3/3) |
| SYMB | DATE | APPD | CHKD | DSGD | | | | |

| CLASS No. | | TITLE | | | | | | | | | | |
|--|---|------------|---|-------------------|------------|---|--------|--------|---|--------|--------|---|
| 1. はんだ試験 Soldering examination. | | | | | | | | | | | | |
| 項目 Item | 条 件 Conditions | | 規 格 Specifications | | | | | | | | | |
| 1-1 はんだ耐熱性試験 Soldering heatproof. | 条件1 Condition 1 プリヒート : 基板表面温度100~140℃, 時間40秒以内 Preheating: ・Surface temperature of board: 100 to 140℃ ・Preheating time: Within 40s. はんだ温度: 265℃以下 Solder temperature: 265℃ or less. 浸漬時間: 10秒以内 Dipping time of soldering: Within 10s. | | 初期規格を満足すること。 Must meet the initial specifications. | | | | | | | | | |
| | 条件2 Condition 2 277先温度: 390℃以下 Bit temperature of soldering iron: 390℃ or less. 加熱時間: 3秒以内 Application time of soldering iron: Within 3s. 加熱回数: 2回 Maximum frequency of soldering: 2 time | | | | | | | | | | | |
| 1-2 はんだ付け性試験 Soldering bill. | 条件1 Condition 1 溶融温度 : 250±2℃ Temperature of soldering. フラックス : W/Wロジン Flux : W/W rosin はんだ : Sn-3.0Ag-0.5Cu Solder 上記の条件のハンダ槽にフラックスを塗布し端子先端を浸漬する。(浸漬深さ: 2~5mm, 浸漬速度: 20±5mm/s.) The terminal point which spreads the flux on the solder tank is soaked. (terminal point: 2~5mm, time: 20±5mm/s.) | | 浸漬面の95%以上がはんだで覆われていること。 95% or more on the dipping side must be covered with solder. | | | | | | | | | |
| | 条件2 Condition 2 プリヒート : 基板表面温度100~140℃, 時間40秒以内 Preheating: ・Surface temperature of board: 100 to 140℃ ・Preheating time: Within 40s. はんだ温度 : 250℃±2℃ Solder temperature: 250℃±2℃ 浸漬時間 : 3秒以内 Dipping time of soldering: Within 3s. フラックス : タムラ化成(株)製CF-110VH-2A, 及び同等品 Flux : TAMURA KAKEN CORPORATION : CF-110VH-2A or the equal article はんだ : Sn-3.0Ag-0.5Cu Solder | | | | | | | | | | | |
| 1-3 電気差合寿命試験 Electrical joint life test by soldering | 下記に示した温度サイクルを連続3,000サイクル行う。 The switch shall be subjected to 3,000 successive change of temperature cycles. <table border="1"> <thead> <tr> <th>段階 Step</th> <th>温度 Temperature</th> <th>時間 Time</th> </tr> </thead> <tbody> <tr> <td>1</td> <td>-40±3℃</td> <td>30min.</td> </tr> <tr> <td>2</td> <td>+85±3℃</td> <td>30min.</td> </tr> </tbody> </table> | | 段階 Step | 温度 Temperature | 時間 Time | 1 | -40±3℃ | 30min. | 2 | +85±3℃ | 30min. | (1) 半田接着強度は、初期値の50%以上あること。 (2) 電気的導通のあること (3) 導通部分が確実に確保できていること (1) Solder clinging strength: Relative to the previously specified value, 50% or more. (2) There shall be electrical conduction. (3) There shall be observed physical succession of conductive components. |
| 段階 Step | 温度 Temperature | 時間 Time | | | | | | | | | | |
| 1 | -40±3℃ | 30min. | | | | | | | | | | |
| 2 | +85±3℃ | 30min. | | | | | | | | | | |

| | | | | | | | | | | |
|------|------|------|------|------|--------------------------------|------------------------|---------------------------|--------------|--|--|
| | | | | | ALPS ELECTRIC CO., LTD. | | | | | |
| | | | | | APPD. | CHKD. | DSGD. | TITLE | | |
| | | | | | C2枚(G) '14-09-08 漆原 | C2枚 '14-09-08 水津 | C2枚 '14-09-08 佐藤(加) | DOCUMENT NO. | | |
| SYMB | DATE | APPD | CHKD | DSGD | | | | L-E59 (1/1) | | |

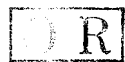

| | | |
|-----------|-------|--|
| CLASS No. | TITLE | |
|-----------|-------|--|

1) エンコータ*の回路処理は、下図の読取方法を推奨します。
 For pulse count, recommendation is below.

| 出力変化順序 → Order of output signal | | 回転方向判定 |
|------------------------------------|-------|----------------|
| A-C | 1 0 0 | CW方向 |
| B-C | 1 1 0 | CW Direction |
| A-C | 0 1 1 | CW方向 |
| B-C | 0 0 1 | CW Direction |
| A-C | 1 1 0 | CCW方向 |
| B-C | 1 0 0 | CCW Direction |
| A-C | 0 0 1 | CCW方向 |
| B-C | 0 1 1 | CCW Direction |
| A-C | 1 0 1 | 無効 |
| B-C | 1 1 1 | Not applicable |
| A-C | 1 1 1 | 無効 |
| B-C | 1 0 1 | Not applicable |
| A-C | 0 1 0 | 無効 |
| B-C | 0 0 0 | Not applicable |
| A-C | 0 0 0 | 無効 |
| B-C | 0 1 0 | Not applicable |

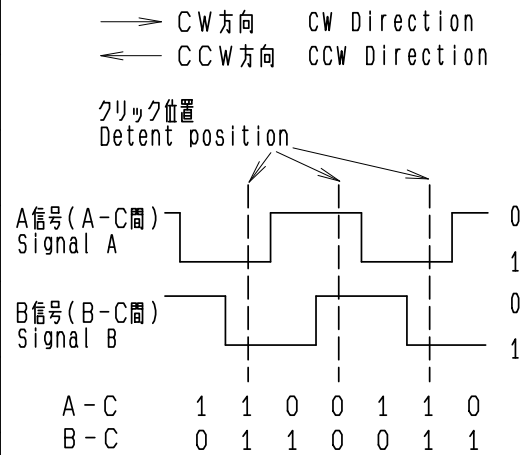

クリック位置より、A信号が先に変化後、B信号が変化した時にCW方向と判定。
 クリック位置より、B信号が先に変化後、A信号が変化した時にCCW方向と判定。
 どちらかの信号が変化しない時は、無効とする。

From detent position, phase A changes first then phase B change follows,
 it means CW direction.
 If either phase has no change it is not valid.

| | | | | | | | | |
|--------------------------------|--|--|--|--|--------------|------------|------------|--------------|
| ALPS ELECTRIC CO., LTD. | | | | | | | | |
| | | | | | APPD. | CHKD. | DSGD. | TITLE |
| | | | | | M-ENG2 | M-ENG2 | M-ENG2 | |
| | | | | | S. MIZOBUCHI | K. HIROSE | H. MIURA | DOCUMENT NO. |
| | | | | | 2012-01-30 | 2012-01-30 | 2012-01-30 | 4LE-30 (1/1) |

注記 軸受材質：亜鉛タ'イキャスト
軸材質：アルミニウム

NOTES BUSHING MATERIAL: ZINC ALLOY DIE CASTING
SHAFT MATERIAL: ALUMINUM

(SW01) ENCODER
(SW02) PUSH ON SW

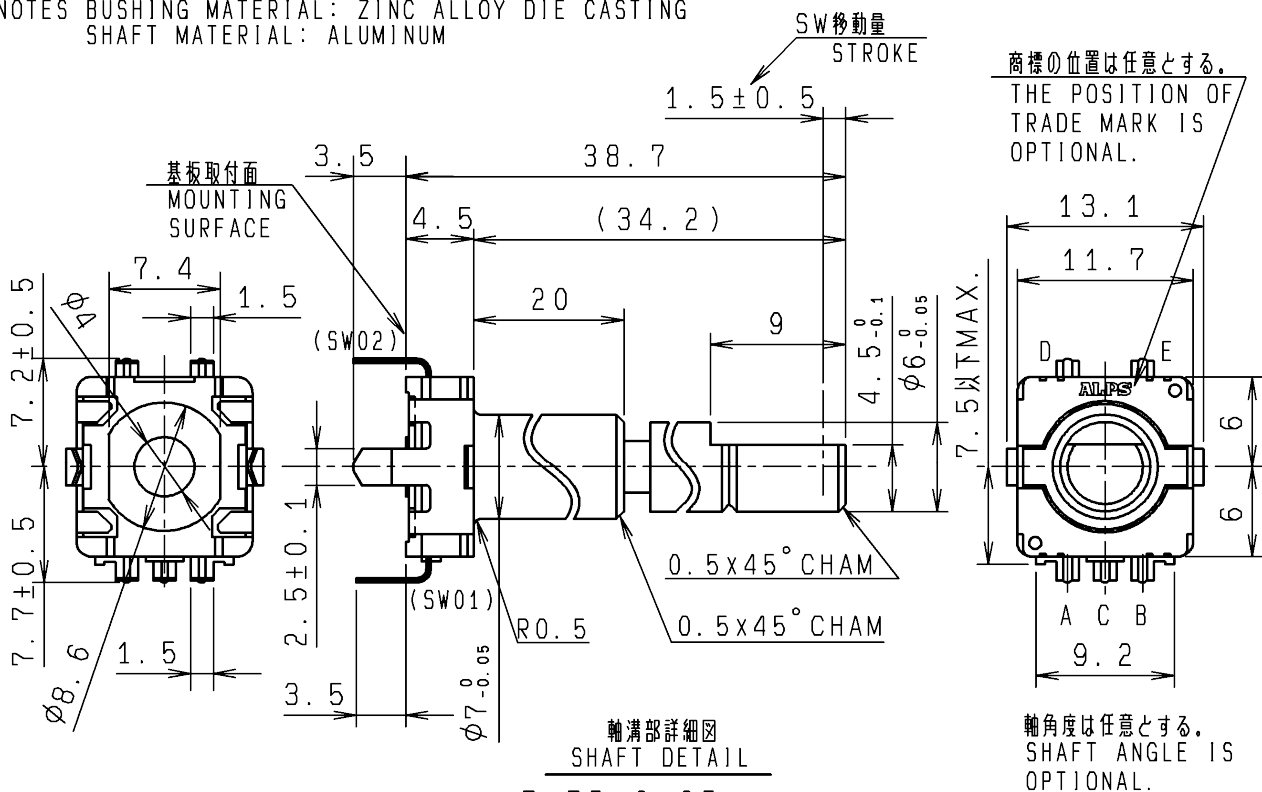

軸溝部詳細図
SHAFT DETAIL

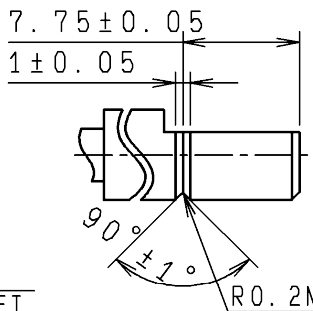

取付穴寸法図 許容差 ± 0.1
(部品挿入側)
P. W. B. MOUNTING DETAIL
TOLERANCE ± 0.1
VIEWED FROM MOUNTING SIDE

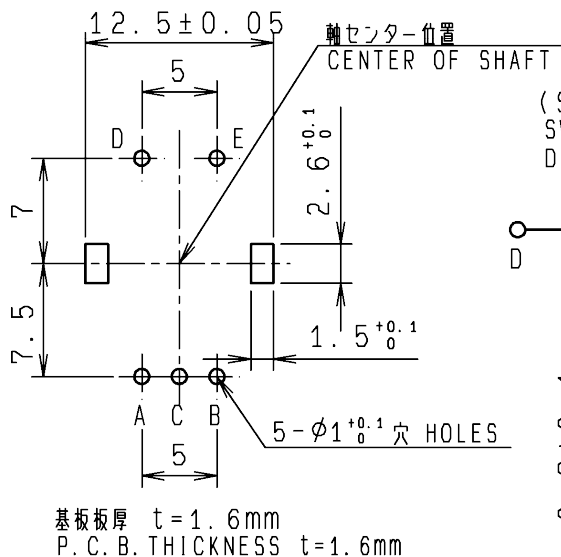

(SW02) 回路図
SWITCH CIRCUIT DIAGRAM

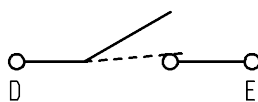

A-C端子間
TERMINAL A-C

B-C端子間
TERMINAL B-C

(SW01) 出力信号
ENCODER OUTPUT SIGNAL

時計方向回転
CW ROTATION

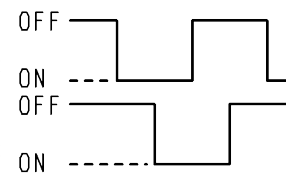

基板挿入部端子形状詳細 (3:1)
TERMINAL DETAIL

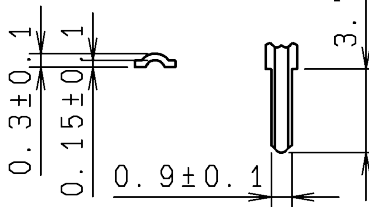

| 指定なき部分の許容差 TOLERANCES UNLESS OTHERWISE SPEC | |
|--|-------|
| $L \leq 10$ | ± 0.3 |
| $10 < L < 100$ | ± 0.5 |
| $100 \leq L$ | ± 0.8 |
| 角度 ANGULAR DIMENSION | ± 5° |

| | | | | | |
|--------------------------------|------|----------------------------------|----------------|-------------------------------------|--|
| | | | | 15P/30C 重クリック品 | |
| PART NO. | NAME | MATERIAL NAME / CODE | FINISH | | |
| ALPS ELECTRIC CO., LTD. | | | | | |
| | | DSGD. Y. SHIMIZU 2010-12-08 | SCALE 2 : 1 | NO. | |
| | | CHKD. H. MIURA 2010-12-08 | | TITLE 11形1軸 PUSH ON SW付エンコータ'組立図 | |
| | | APPD. S. MIZOBUCHI 2010-12-08 | UNIT mm | DOCUMENT NO. LA2115EC7 | |
| SYMB | DATE | APPD | CHKD | DSGD | |