

Feature

- Surface Mount Schottky Barrier Rectifier Rectifiers
- Reverse Voltage 20 to 200 V
- Forward Current 1.0 A

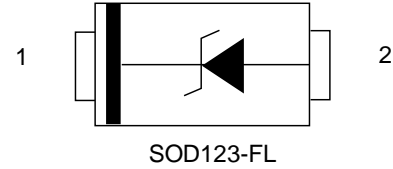

Maximum Ratings and Electrical characteristics per line@25°C (unless otherwise specified)
Single phase half-wave 60 Hz, resistive or inductive load, for capacitive load current derate by 20 %

| Parameter | Symbols | 20V1H | 40V1H | 60V1H | 80V1H | 100V1H | 120V1H | 150V1H | 200V1H | Units |
|---|-----------------|----------|-------|-------|-------|--------|--------|--------|--------|--------------------|
| Maximum Repetitive Peak Reverse Voltage | V_{RRM} | 20 | 40 | 60 | 80 | 100 | 120 | 150 | 200 | V |
| Maximum RMS voltage | V_{RMS} | 14 | 28 | 42 | 56 | 80 | 100 | 105 | 140 | V |
| Maximum DC Blocking Voltage | V_{DC} | 20 | 40 | 60 | 80 | 100 | 120 | 150 | 200 | V |
| Maximum Average Forward Rectified Current at $T_a = 65\text{ }^\circ\text{C}$ | $I_{F(AV)}$ | 1 | | | | | | | | A |
| Peak Forward Surge Current 8.3 ms Single Half Sine Wave Superimposed on Rated Load (JEDEC Method) | I_{FSM} | 40 | | | | 30 | | | | A |
| Maximum Instantaneous Forward Voltage at 1 A | V_F | 0.55 | 0.70 | | 0.85 | | 0.90 | | V | |
| Maximum DC Reverse Current $T_a = 25\text{ }^\circ\text{C}$ at Rated DC Blocking Voltage $T_a = 125\text{ }^\circ\text{C}$ | I_R | 0.3 | | | | 0.2 | | 0.1 | | mA |
| | | 10 | | | | 5 | | 2 | | |
| Typical Junction Capacitance ¹⁾ | C_j | 110 | 80 | | | | | | | pF |
| Typical Thermal Resistance ²⁾ | $R_{\theta JA}$ | 115 | | | | | | | | $^\circ\text{C/W}$ |
| Operating and Storage Temperature Range | T_j, T_{stg} | -55~+150 | | | | | | | | $^\circ\text{C}$ |

-
- 1) Measured at 1 MHz and applied reverse voltage of 4 V D.C
- 2) Thermal resistance from junction to ambient at 0.375" (9.5 mm) lead length, P.C.B. mounted

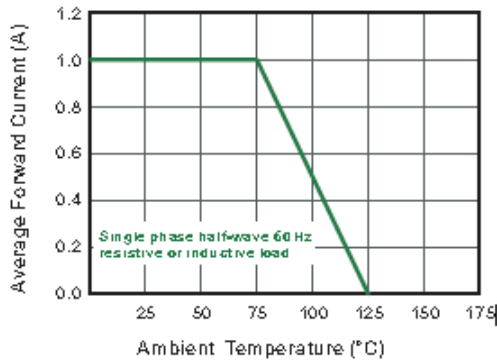

Fig.1 Forward Current Derating Curve

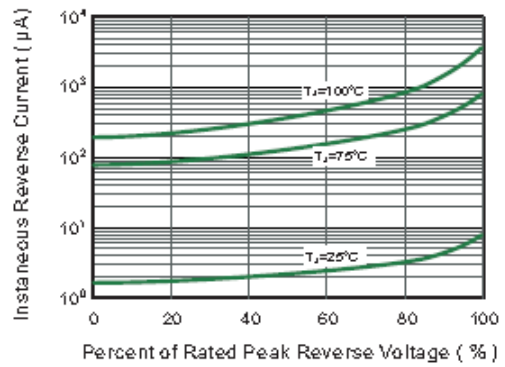

Fig.2 Typical Reverse Characteristics

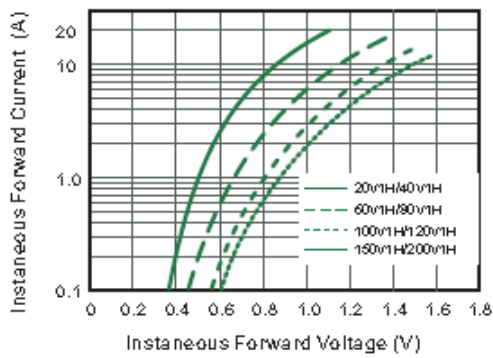

Fig.3 Typical Forward Characteristic

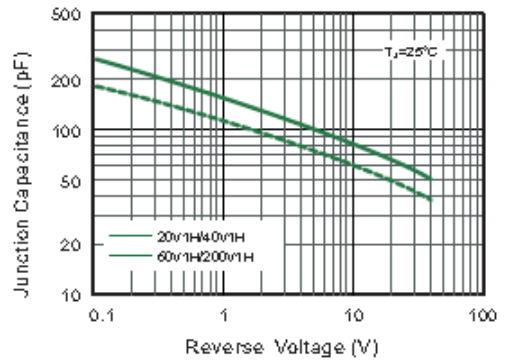

Fig.4 Typical Junction Capacitance

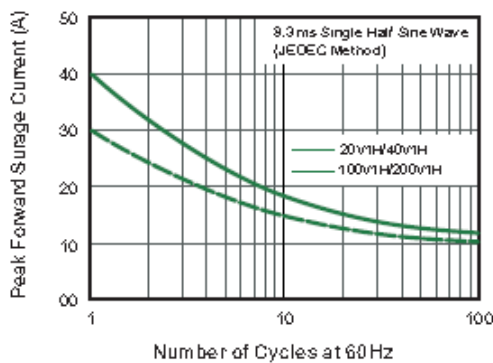

Fig.5 Maximum Non-Repetitive Peak Forward Surge Current

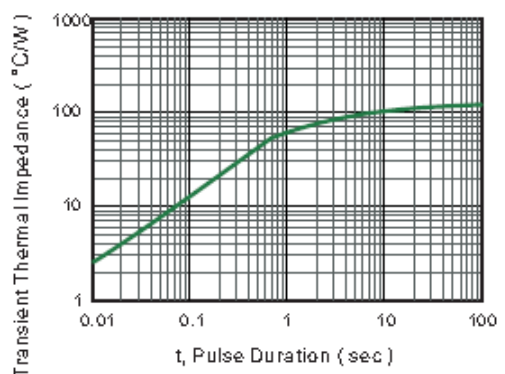
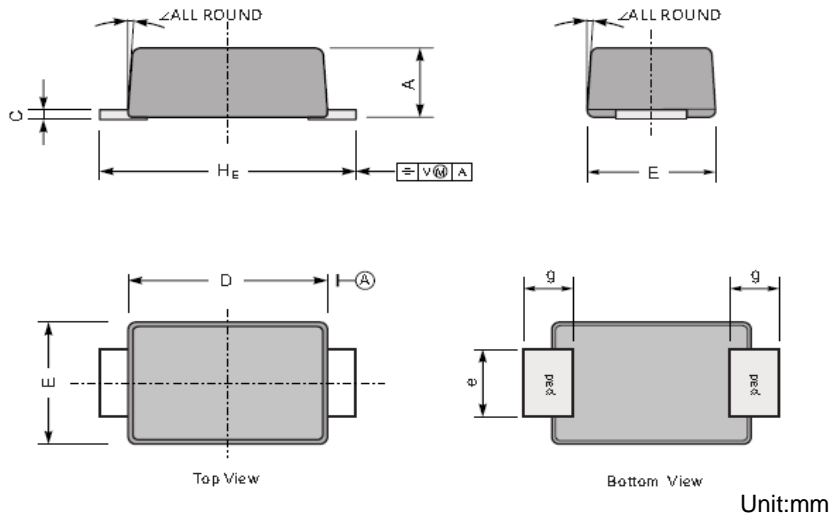

Fig.6 Typical Transient Thermal Impedance

Product dimension (SOD-123FL)



| UNIT | | A | C | D | E | e | g | H _E | ∠ |
|------|-----|-----|------|-----|-----|-----|-----|----------------|----|
| mm | max | 1.1 | 0.20 | 2.9 | 1.9 | 1.1 | 0.9 | 3.8 | 7° |
| | min | 0.9 | 0.12 | 2.6 | 1.7 | 0.8 | 0.7 | 3.5 | |
| mil | max | 43 | 7.9 | 114 | 75 | 43 | 35 | 150 | |
| | min | 35 | 4.7 | 102 | 67 | 31 | 28 | 138 | |

The recommended mounting pad size

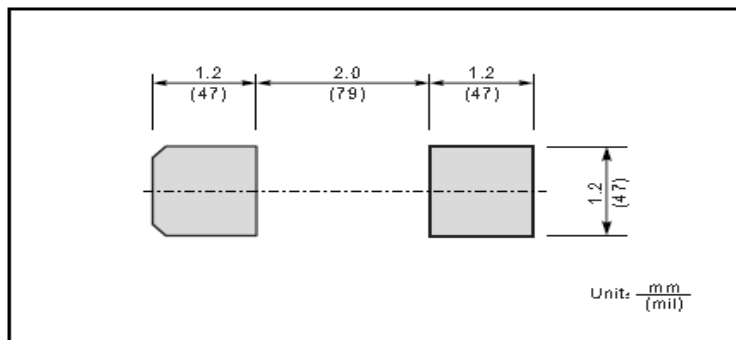

• Recommended condition of flow soldering

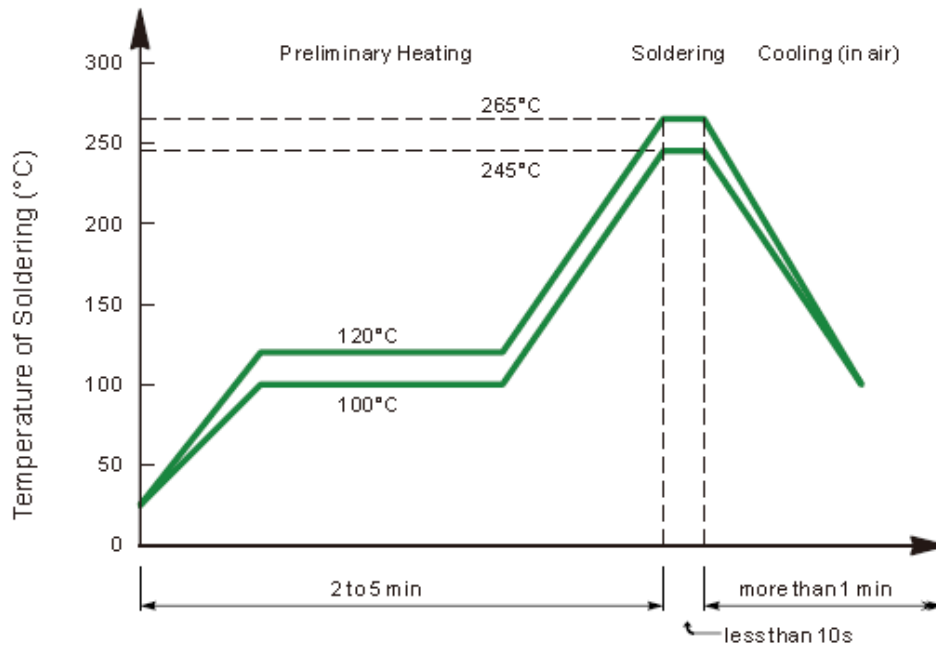

• Recommended condition of reflow soldering

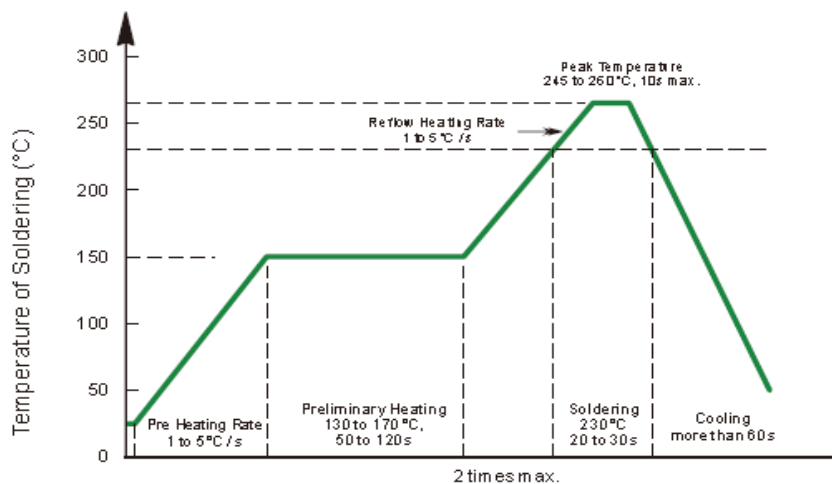

Recommended peak temperature is over 245 °C. If peak temperature is below 245 °C, you may adjust the following parameters; time length of peak temperature (longer), time length of soldering (longer), thickness of solder paste (thicker)

• Condition of hand soldering

Temperature: 370°C
 Time: 3s max.
 Times: one time

• Remark:

Lead free solder paste (98.5Sn/3.0Ag/0.5Cu)

Marking information

| Device | Marking |
|--------------|---------|
| PSBD1DF20V1H | S12 |
| PSBD1DF40V1H | 14A |

Ordering information

| Device | Package | Reel | Shipping |
|--------------|---------------------|------|--------------------|
| PSBD1DFXXV1H | SOD-123FL (Pb-Free) | 7" | 3000 / Tape & Reel |

IMPORTANT NOTICE

 and **Prisemi**[®] are registered trademarks of **Prisemi Electronics Co., Ltd (Prisemi)** ,Prisemi reserves the right to make changes without further notice to any products herein. Prisemi makes no warranty, representation or guarantee regarding the suitability of its products for any particular purpose, nor does Prisemi assume any liability arising out of the application or use of any product or circuit, and specifically disclaims any and all liability, including without limitation special, consequential or incidental damages. “Typical” parameters which may be provided in Prisemi data sheets and/or specifications can and do vary in different applications and actual performance may vary over time. All operating parameters, including “Typicals” must be validated for each customer application by customer’s technical experts. Prisemi does not convey any license under its patent rights nor the rights of others. The products listed in this document are designed to be used with ordinary electronic equipment or devices, Should you intend to use these products with equipment or devices which require an extremely high level of reliability and the malfunction of with would directly endanger human life (such as medical instruments, aerospace machinery, nuclear-reactor controllers, fuel controllers and other safety devices), please be sure to consult with our sales representative in advance.

Website: <http://www.prisemi.com>

For additional information, please contact your local Sales Representative.

©Copyright 2009, Prisemi Electronics

 **Prisemi**[®] is a registered trademark of Prisemi Electronics.

All rights are reserved.