

Description

The enhancement mode MOS is extremely high density cell and low on-resistance.

MOSFET Product Summary		
$V_{DS}(V)$	$R_{DS(on)}(m\Omega)$	$I_D(A)$
-12	12 @ $V_{GS}=-4.5V$	-10

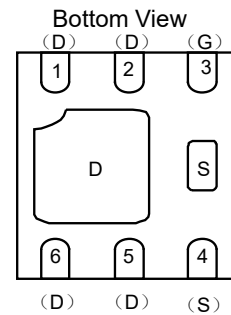
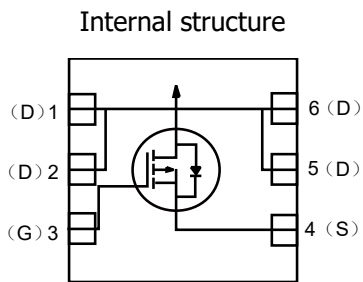

Absolute maximum rating@25°C

Rating	Symbol	Value	Units
Drain-Source Voltage	V_{DS}	-12	V
Gate-Source Voltage	V_{GS}	± 8.0	V
Drain Current	Continuous $T_A=25^\circ C$	I_D	-10 A
	Pulsed $T_A=70^\circ C$	I_D	-40 A
Total Power Dissipation	$T_A=25^\circ C$	P_D	2.4 W
	$T_A=125^\circ C$	P_D	0.9 W
Operating and Storage Junction Temperature Range	T_J, T_{STG}	-55 to +150	$^\circ C$

Thermal Characteristics

Parameter	Symbol	Max.	Units
Thermal Resistance, Junction to Ambient (Note 1a)	$R_{\theta JA}$	52	$^\circ C/W$
Thermal Resistance, Junction to Ambient (Note 1b)	$R_{\theta JA}$	145	
Thermal Resistance, Junction to Case	$R_{\theta JC}$	6.9	

Electrical characteristics per line@25°C (unless otherwise specified)

Parameter	Symbol	Conditions	Min.	Typ.	Max.	Units
Drain-Source Breakdown Voltage	BV_{DSS}	$I_D = -250\mu A, V_{GS} = 0V$	-12	-	-	V
Zero Gate Voltage Drain Current	I_{DSS}	$V_{DS} = -9.6V, V_{GS} = 0V$	-	-	-1.0	μA
Gate-to-Source Forward Leakage	I_{GSS}	$V_{GS} = \pm 8.0V$	-	-	± 100	nA
Gate Threshold Voltage	$V_{GS(th)}$	$V_{DS} = V_{GS}, I_D = -250\mu A$	-0.4	-0.7	-1.0	V
Static Drain-Source On-Resistance	$R_{DS(on)}$	$V_{GS} = -4.5V, I_D = -7A$	-	12	17	m Ω
		$V_{GS} = -2.5V, I_D = -6A,$	-	18	24	m Ω
		$V_{GS} = -1.8V, I_D = -4.5A,$	-	25	80	m Ω
Forward Trans conductance	g_{FS}	$V_{DS} = -5V, I_D = -10A$	-	50	-	S
Total Gate Charge	Q_g	$I_D = -10A, V_{DD} = -6V,$ $V_{GS} = -4.5V$	-	21	29	nC
Gate-to-Source Charge	Q_{gs}		-	3.5		
Gate-to-Drain(Miller) Charge	Q_{gd}		-	4.2		
Input Capacitance	C_{ISS}	$V_{GS} = 0V, V_{DS} = -6V,$ $f = 1MHz$	-	2559	3405	pF
Output Capacitance	C_{DSS}		-	490	735	pF
Reverse Transfer Capacitance	C_{RSS}		-	437	655	pF
Turn-On Delay Time	$t_{d(on)}$	$V_{DD} = -6.0V, I_D = -10A,$ $V_{GS} = -4.5V, R_{GEN} = 6\Omega,$	-	11	20	ns
Rise Time	t_r		-	11	20	
Turn-Off Delay Time	$t_{d(off)}$		-	120	192	
Fall Time	t_f		-	59	94	
Source to Drain Diode Forward Voltage	V_{SD}	$V_{GS} = 0V, I_S = -2A$		-0.6	-1.2	V
		$V_{GS} = 0V, I_S = -10A$		-0.8	-1.2	
Reverse Recovery Time	t_{rr}	$I_F = -10A, di/dt = 100A/\mu s$		21	34	ns
Reverse Recovery Charge	Q_{rr}			6.1	12	nC

Typical Characteristics

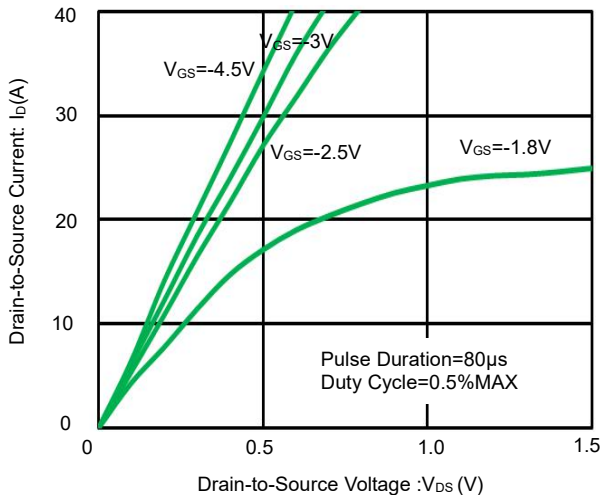

Fig 1. On-Region Characteristics

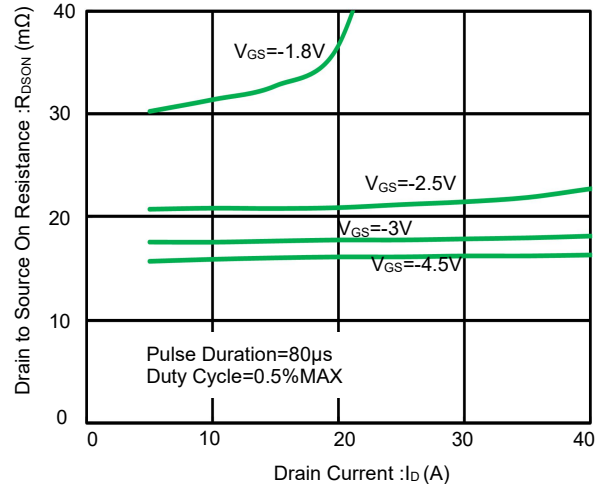

Fig 2. On-Resistance vs. Drain Current

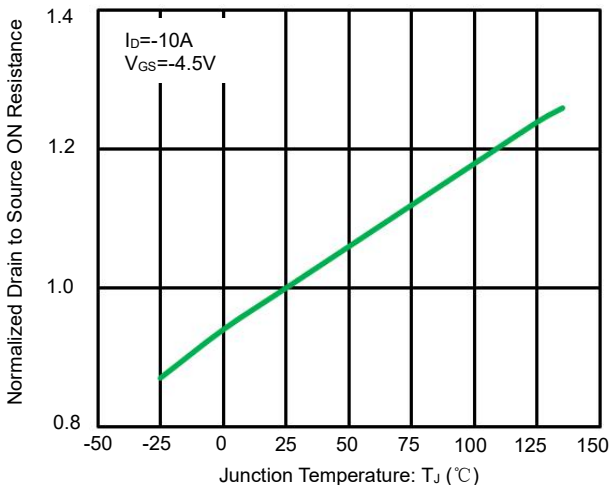

Fig 3. Normalized On-Resistance vs. Junction Temperature

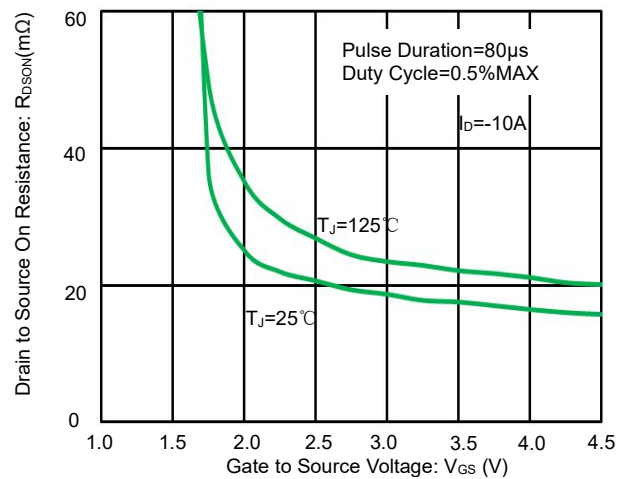

Fig 4. On-Resistance vs. Gate-to-Source Voltage

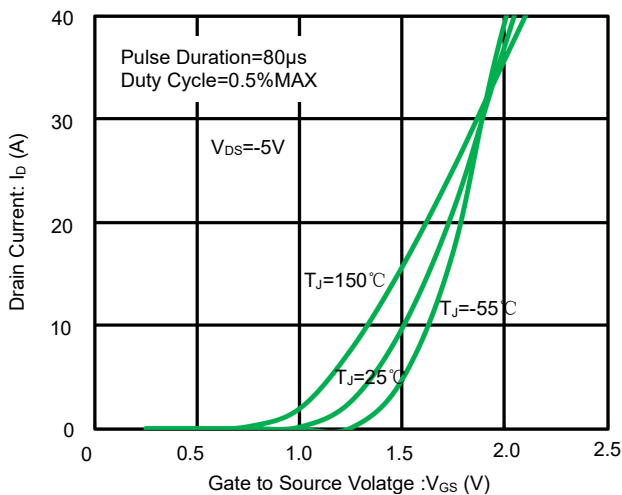

Fig 5. Transfer Characteristics

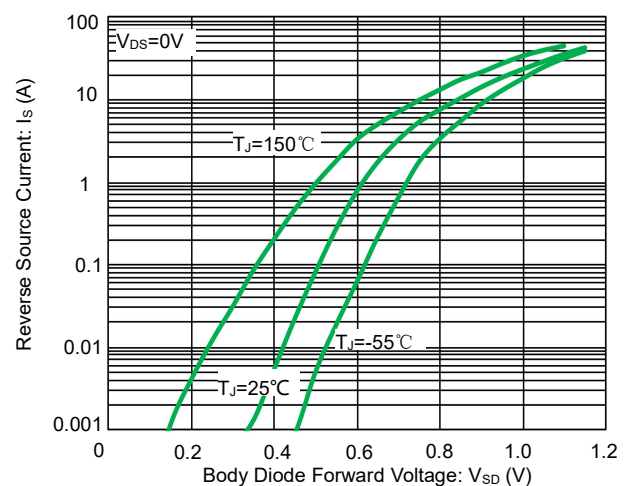

Fig 6. Reverse Source Current vs. Source to Drain Diode Forward Voltage

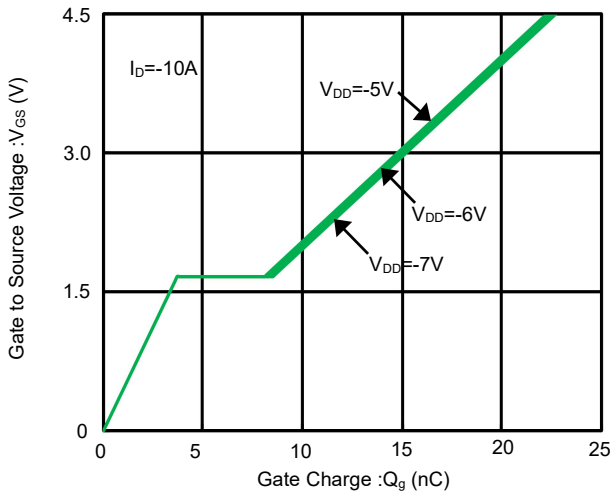

Fig 7. Gate Charge Characteristics

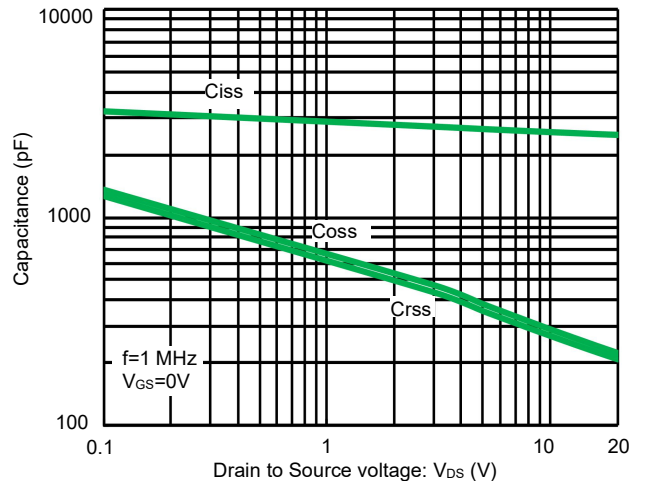

Fig 8. Capacitance vs. Drain-to-Source Voltage

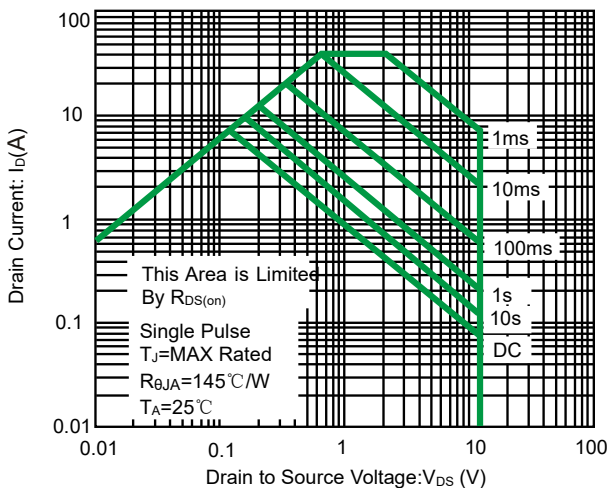

Fig 9. Forward Bias Safe Operating Area

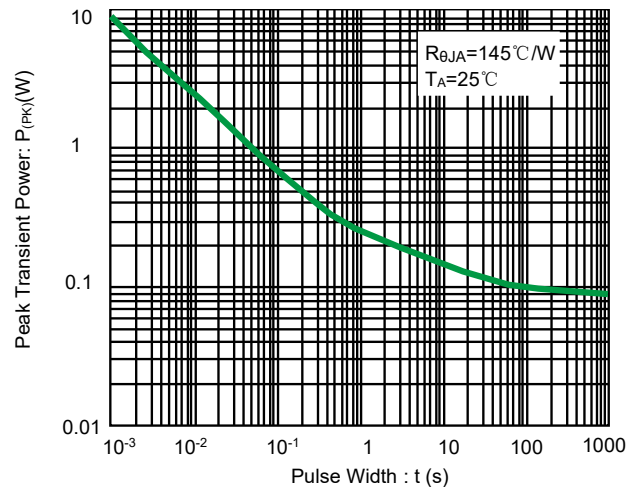

Fig 10. Single Pulse Maximum Power Dissipation

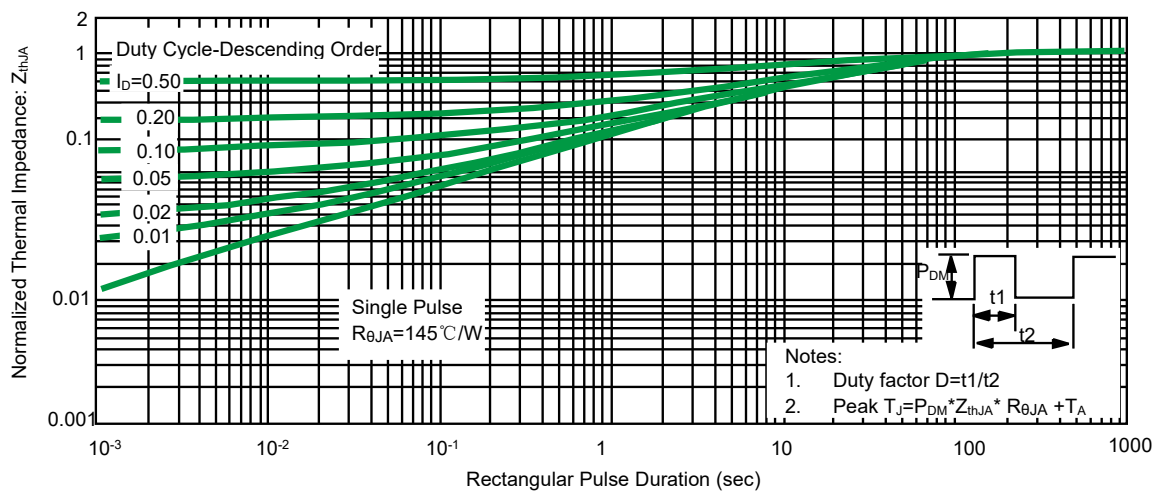
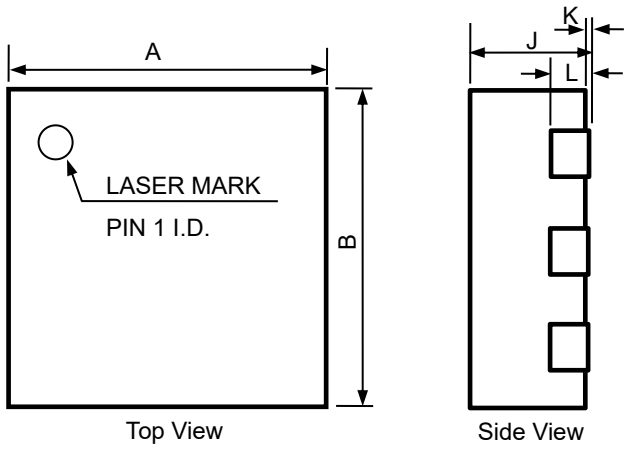
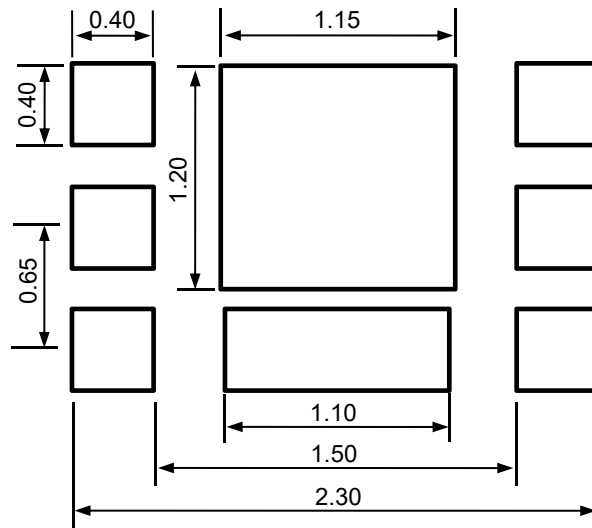
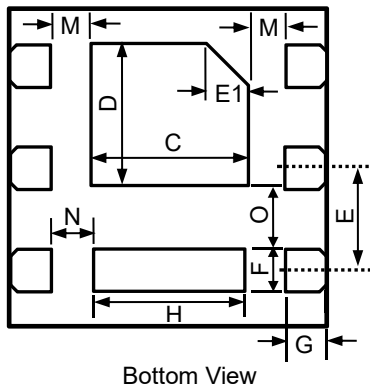

Fig 11. Transient Thermal Response Curve, Junction-to-Ambient

Product dimension (DFN2*2-6L)



Dim	Millimeters	
	MIN	MAX
A	1.90	2.10
B	1.90	2.10
C	0.70	1.10
D	0.80	1.00
E	0.55	0.75
E1	0.25 Ref.	
F	0.25	0.35
G	0.20	0.35
H	0.50	1.00
J	0.60	0.80
K	0.00	0.05
L	0.20 Ref.	
M	0.15	--
N	0.20	--
O	0.25	--



Suggested PCB Layout

Marking information

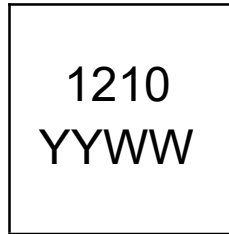

YY =Year code
 WW =Week code

Ordering information

Device	Package	Reel	Shipping
PPM6N12V10	DFN2*2-6L	7"	3000 / Tape & Reel

IMPORTANT NOTICE

 and **Prisemi**[®] are registered trademarks of **Prisemi Electronics Co., Ltd (Prisemi)** ,Prisemi reserves the right to make changes without further notice to any products herein. Prisemi makes no warranty, representation or guarantee regarding the suitability of its products for any particular purpose, nor does Prisemi assume any liability arising out of the application or use of any product or circuit, and specifically disclaims any and all liability, including without limitation special, consequential or incidental damages. "Typical" parameters which may be provided in Prisemi data sheets and/or specifications can and do vary in different applications and actual performance may vary over time. All operating parameters, including "Typicals" must be validated for each customer application by customer's technical experts. Prisemi does not convey any license under its patent rights nor the rights of others. The products listed in this document are designed to be used with ordinary electronic equipment or devices, Should you intend to use these products with equipment or devices which require an extremely high level of reliability and the malfunction of with would directly endanger human life (such as medical instruments, aerospace machinery, nuclear-reactor controllers, fuel controllers and other safety devices), please be sure to consult with our sales representative in advance.

Website: <http://www.prisemi.com>

For additional information, please contact your local Sales Representative.

©Copyright 2009, Prisemi Electronics

 **Prisemi**[®] is a registered trademark of Prisemi Electronics.

All rights are reserved.