

**Feature**

This device is Pb-Free, Halogen Free/BFR Free and RoHS compliant.

PNMT6N1-LB is composed by a transistor and a MOSFET

Transistor:

- Very low collector to emitter saturation voltage
- DC current gain <100
- 3A continuous collector current
- PNP epitaxial planar silicon transistor

MOSFET:

MOSFET Product Summary			
V <sub>DS</sub> (V)	R <sub>DS(on)</sub> (Ω)	V <sub>GS(th)</sub> (V)	I <sub>D</sub> (A)
40	4.5@ V <sub>GS</sub> =4V	0.6 to 1.5	0.18

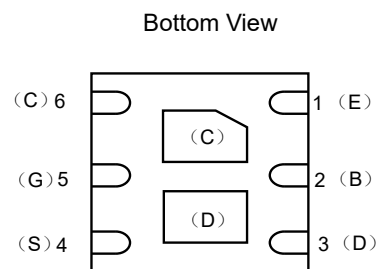
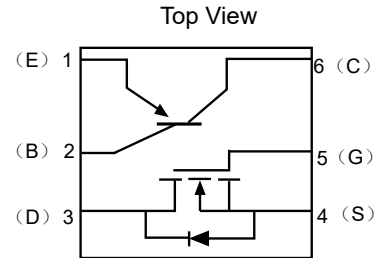

- Transistor

**Electrical characteristics per line@25°C ( unless otherwise specified)**

Parameter	Symbol	Conditions	Value	Units
Collector-Emitter Breakdown Voltage	V <sub>(BR)CEO</sub>	I <sub>C</sub> = -10mA	-30	V
Collector-Base Breakdown Voltage	V <sub>(BR)CBO</sub>	I <sub>C</sub> = -0.1mA	-40	V
Emitter -Base Breakdown Voltage	V <sub>(BR)EBO</sub>	I <sub>E</sub> = -0.1mA	-5	V
Collector Current	I <sub>C</sub>		-3	A
Collector Peak Current	I <sub>CM</sub>		-6	A
Base Current	I <sub>B</sub>		-0.2	A
Base Peak Current	I <sub>BM</sub>		-0.5	A
Total Dissipation @25°C	P <sub>tot</sub>		1.2	W
Storage Temperature	T <sub>stg</sub>		-65~150	°C
Max. Operating Junction Temperature	T <sub>j</sub>		150	°C
Junction-to-Ambient Thermal Resistance <sup>(1)</sup>	R <sub>θJA</sub>		104	°C/ W

Note 1: Surface mounted on FR-4 Board using 1 square inch pad size, 1oz copper

## Absolute maximum rating@25°C

Parameter	Symbol	Conditions	Min.	Typ.	Max.	Units
DC Current Gain	$h_{FE}$	$I_C=-0.001A, V_{CE}=-5.0V$	60		120	-
		$I_C=-0.1A, V_{CE}=-5.0V$	60		105	
		$I_C=-0.5A, V_{CE}=-5.0V$	60		100	
Collector-Emitter Saturation Voltage	$V_{CE(sat)}$	$I_C=-0.5A, I_B=-15mA$			-0.14	V
		$I_C=-1.2A, I_B=-40mA$			-0.23	
		$I_C=-2A, I_B=-220mA$			-0.30	
Base-Emitter Saturation Voltage	$V_{BE(sat)}$	$I_C=-1A, I_B=-0.05mA$			-1.1	V
Collector Cut-off Current ( $I_E=0$ )	$I_{CBO}$	$V_{CB}=-40V$			-0.1	$\mu A$
		$V_{CB}=-30V, T_C=125^\circ C$			-20	
Emitter Cut-off Current( $I_C=0$ )	$I_{EBO}$	$V_{EB}=-5V$			-0.1	$\mu A$

➤ MOSFET

## Electrical characteristics per line@25°C ( unless otherwise specified)

Parameter	Symbol	Conditions	Min.	Typ.	Max.	Units
<b>OFF CHARACTERISTICS</b>						
Drain-Source Breakdown Voltage	$V_{DSS}$	$I_D=10\mu A, V_{GS}=0V$	40	-	-	V
Zero Gate Voltage Drain Current	$I_{DSS}$	$V_{DS}=35V, V_{GS}=0V$	-	-	1	$\mu A$
Gate-Body Leakage Current	$I_{GSS}$	$V_{DS}=0V, V_{GS}=\pm 15V$	-	-	$\pm 1$	$\mu A$
Gate Threshold Voltage	$V_{GS(th)}$	$V_{DS}=V_{GS}, I_D=250\mu A$	0.6	-	1.5	V
Static Drain-Source On-Resistance	$R_{DS(ON)}$	$V_{GS}=4.5V, I_D=0.2A$	-	-	4	$\Omega$
<b>DYNAMIC PARAMETERS</b>						
Input Capacitance	$C_{ISS}$	$V_{GS}=0V, V_{DS}=25V,$ $f=1MHz$	-	-	40	pF
Output Capacitance	$C_{DSS}$		-	-	20	pF
Reverse Transfer Capacitance	$C_{RSS}$		-	-	5	pF
<b>SWITCHING PARAMETERS</b>						
Turn-On Delay Time	$t_{d(on)}$	$V_{DS}=30V, V_{GS}=10V,$ $R_G=25\Omega, R_L=150\Omega$ $I_D=0.2A$	-	-	20	ns
Turn-Off Delay Time	$t_{d(off)}$		-	-	20	ns

Absolute maximum rating@25°C

Rating		Symbol	Value	Units
Drain-Source Voltage		$V_{DS}$	40	V
Gate-Source Voltage		$V_{GS}$	$\pm 20$	V
Drain Current	Continuous	$I_D$	0.18	A
	Pulsed	$I_D$	0.36	A
Total Power Dissipation	$T_A=25^\circ\text{C}$	$P_D$	150	mW

Typical Characteristics

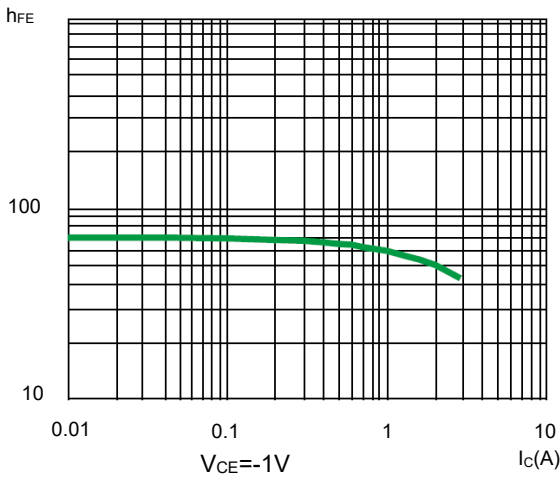

Fig1.DC Current Gain

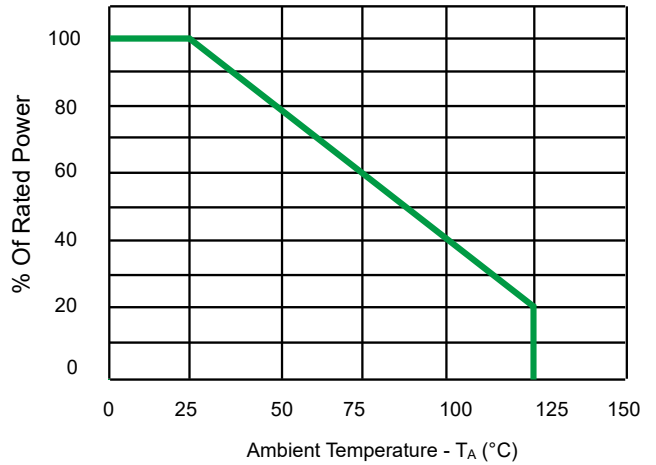

Fig2. Power Derating Curve

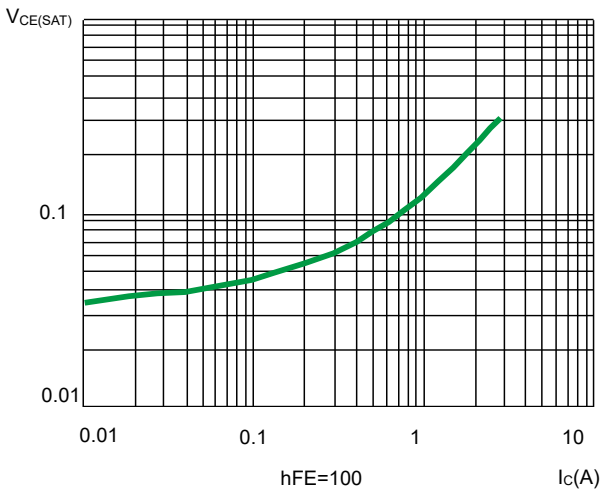

Fig 3.Collector-Emitter Saturation Voltage

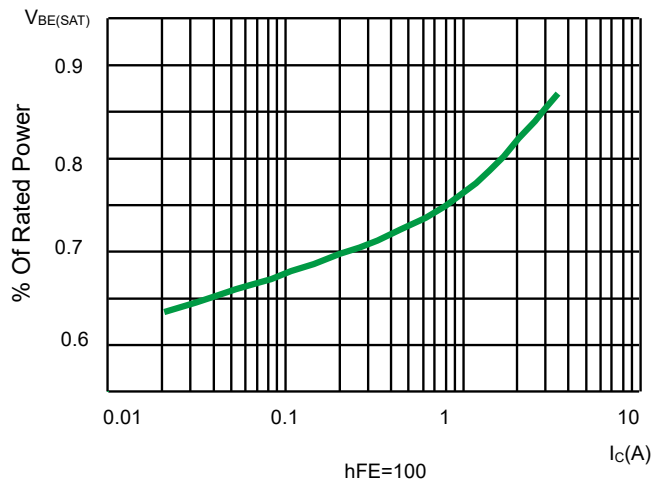

Fig4. Base-Emitter Saturation Voltage

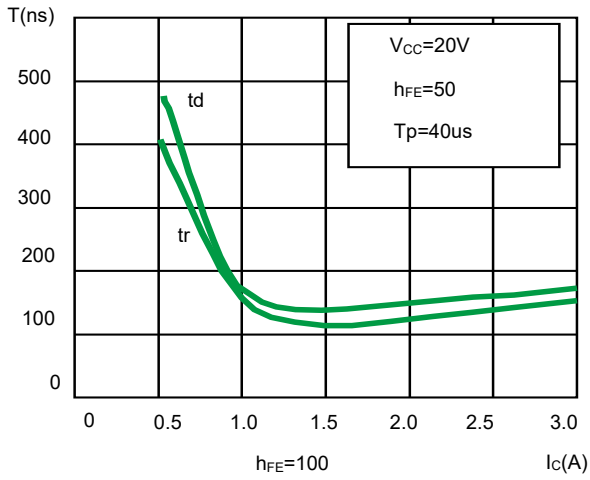

Fig 5. Switching Times Resistive Load

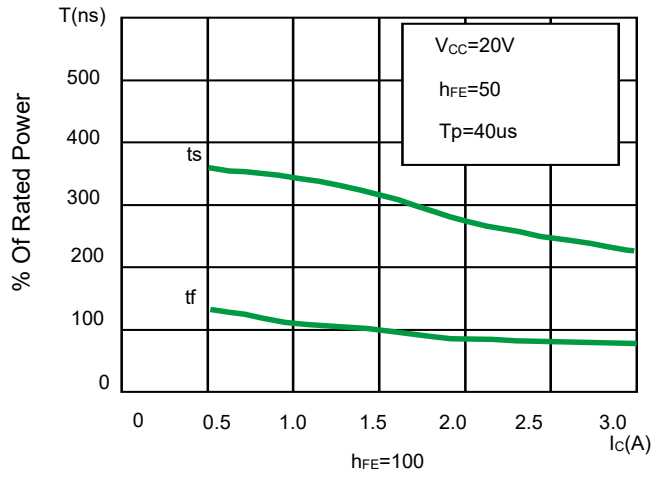

Fig 6. Switching Times Resistive Load

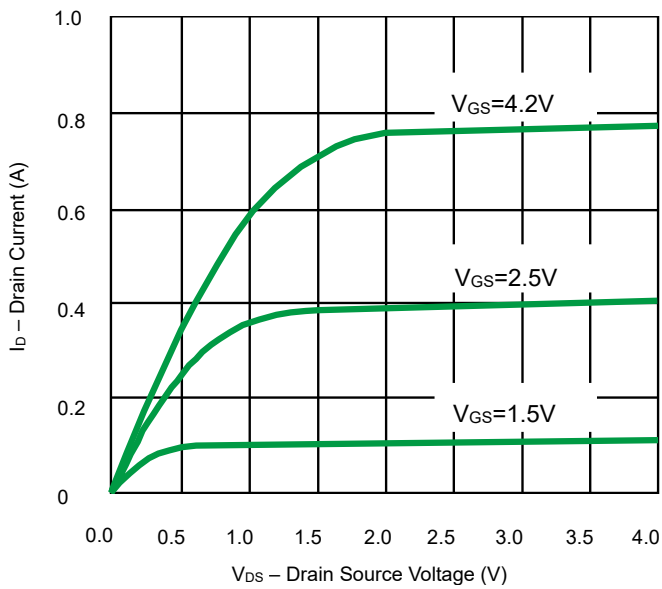

Fig 7. Output Characteristics

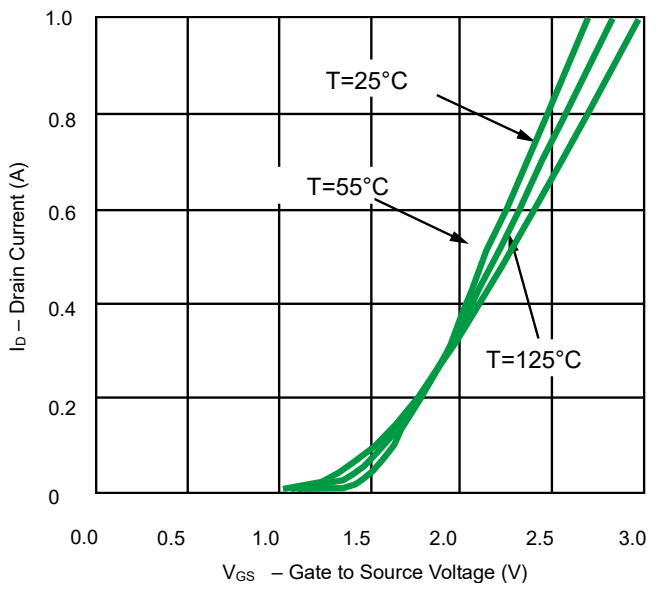

Fig 8. Transfer Characteristics

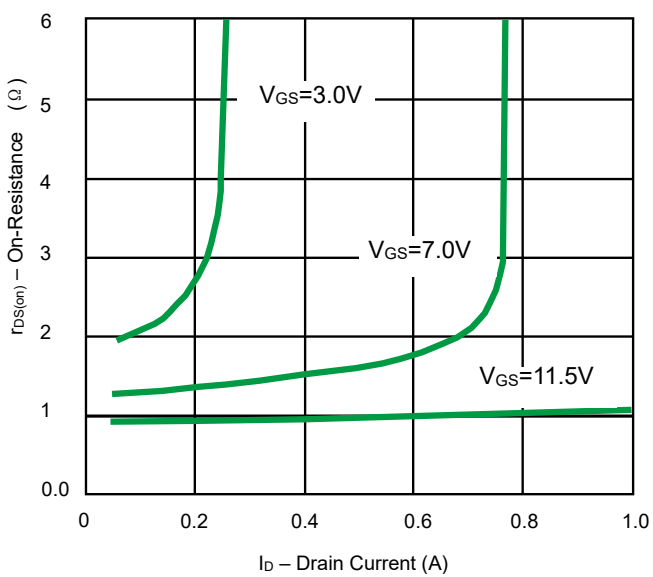

Fig 9. On-Resistance vs. Drain Current

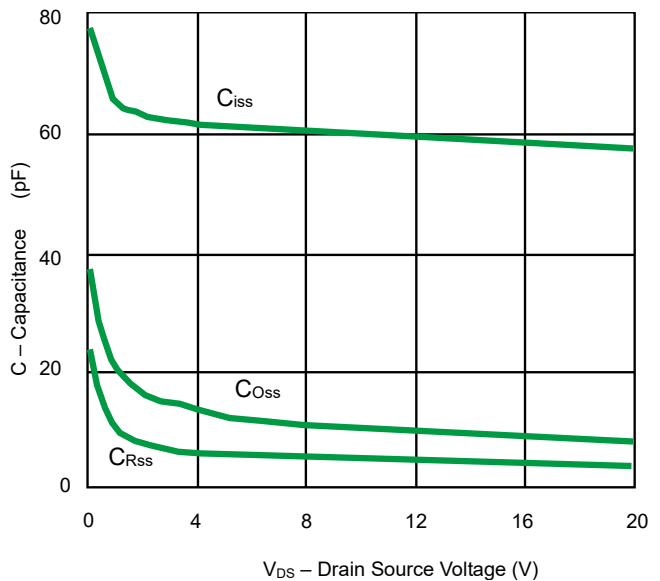
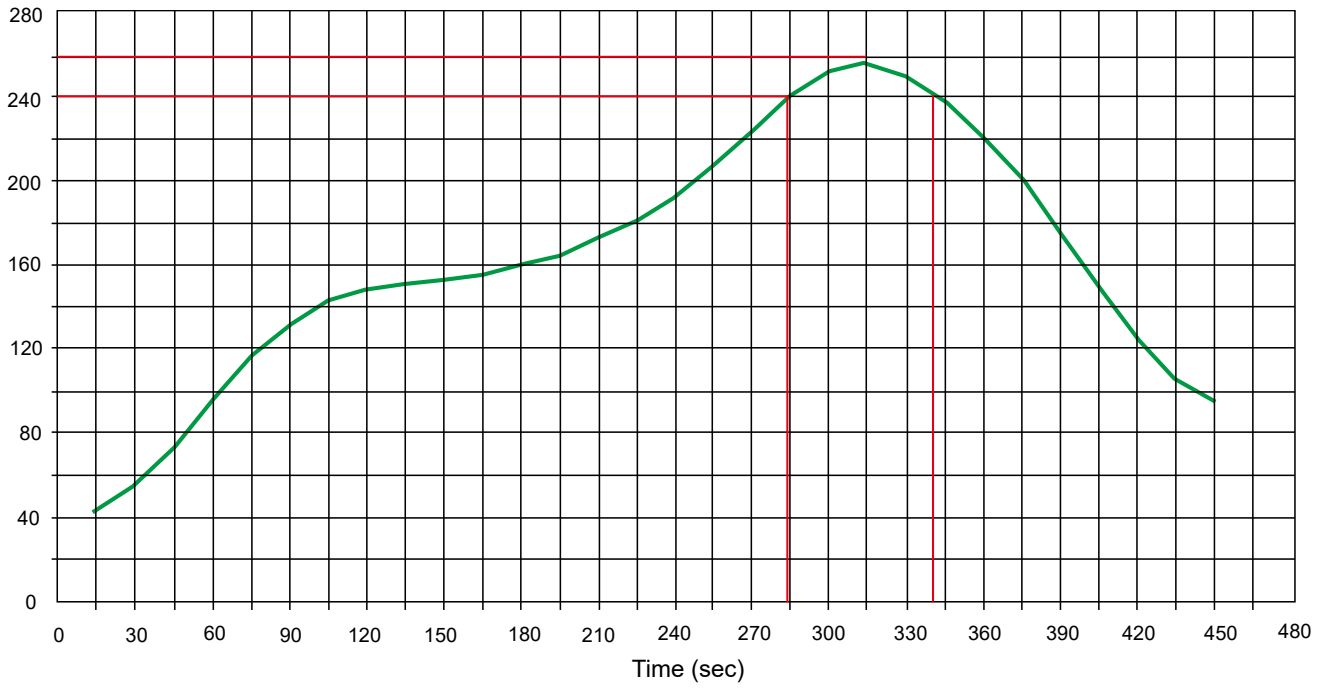

Fig 10. Capacitance

Solder Reflow Recommendation

Peak Temp=257°C, Ramp Rate=0.802deg. °C/sec



Product dimension DFN-6L(2\*2)

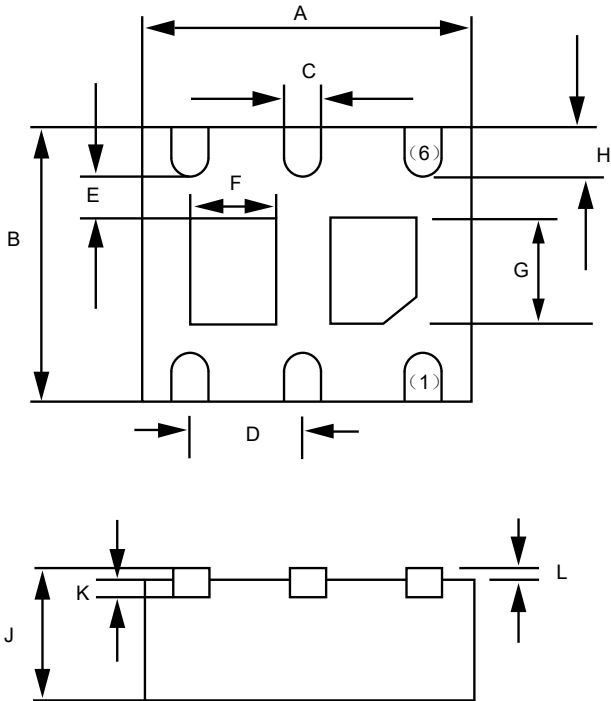

Dim	Millimeters		Inches	
	MIN	MAX	MIN	MAX
A	1.924	2.076	0.076	0.082
B	1.924	2.076	0.076	0.082
C	0.250	0.350	0.010	0.014
D	0.650 (typ.)		0.026 (typ.)	
E	0.200 MIN.		0.008 MIN.	
F	0.520	0.720	0.020	0.028
G	0.900	1.100	0.035	0.043
H	0.174	0.326	0.007	0.013
J	0.550	0.650	0.021	0.027
K	0.206 REF		0.206 REF	
L	0.203 REF		0.203 REF	

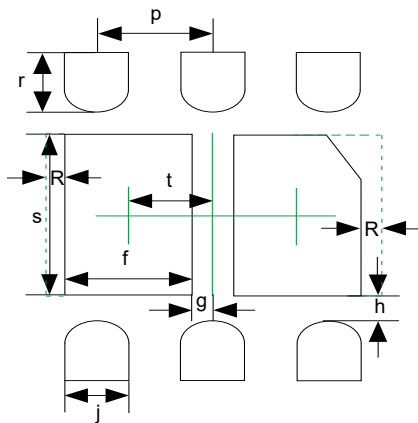

If there is enough place in PCB. It can be mounted with copper along the dotted line in order to optimize thermal design.

Dim	Millimeters	
	MIN	MAX
p	0.60	0.70
r	0.40	0.50
s	1.05	1.15
t	0.42	0.52
f	0.67	0.77
g	0.06	0.16
h	0.1	0.2
j	0.35	0.45
R	0.1	0.2

Marking information

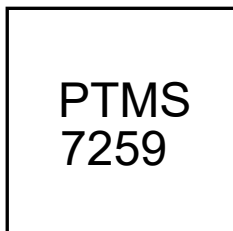

Ordering information

Device	Package	Reel	Shipping
PNMT6N1-LB	DFN-6L (2*2)	7"	3000 / Tape & Reel

Load with information

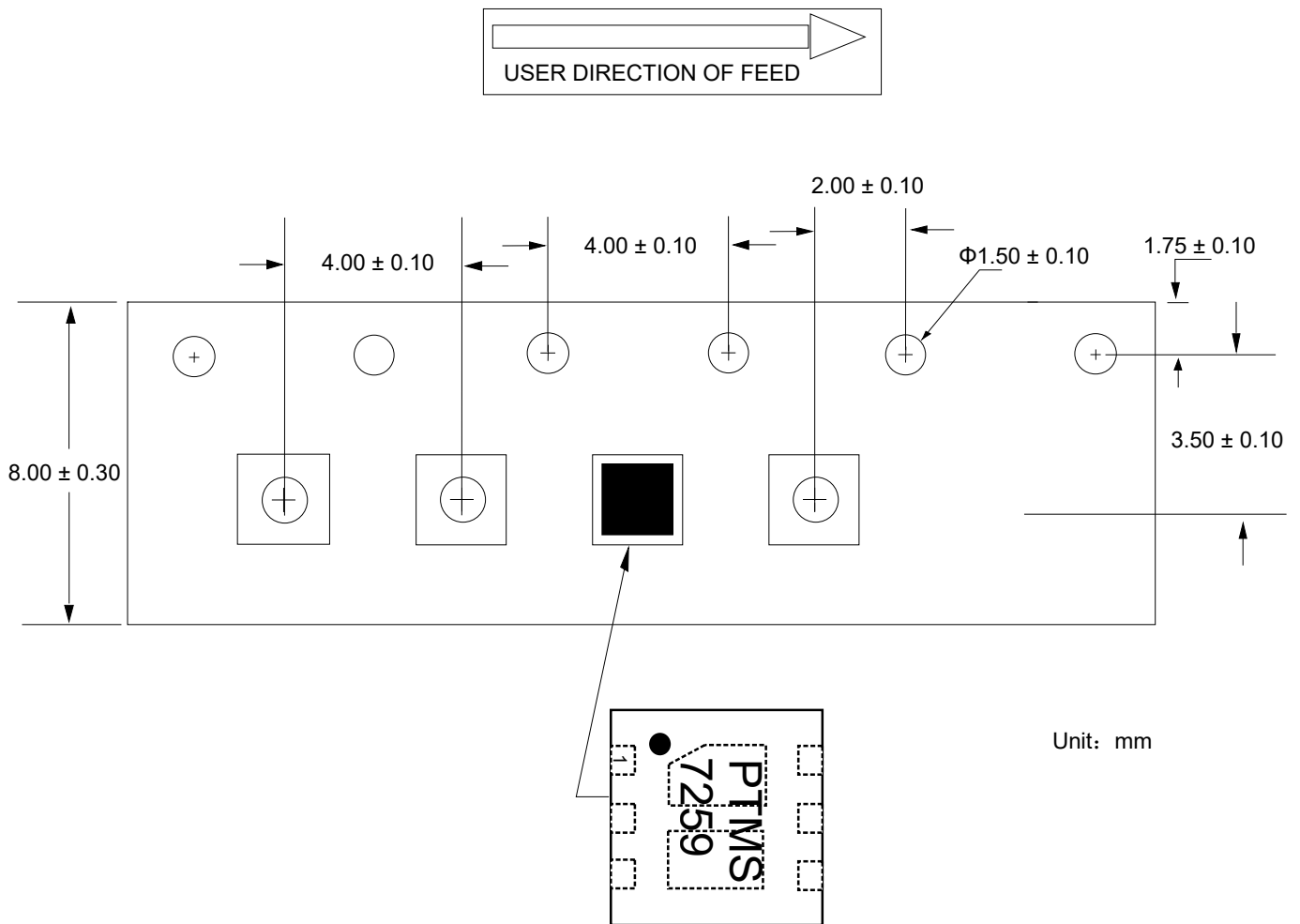

**IMPORTANT NOTICE**

 and **Prisemi**<sup>®</sup> are registered trademarks of **Prisemi Electronics Co., Ltd (Prisemi)** ,Prisemi reserves the right to make changes without further notice to any products herein. Prisemi makes no warranty, representation or guarantee regarding the suitability of its products for any particular purpose, nor does Prisemi assume any liability arising out of the application or use of any product or circuit, and specifically disclaims any and all liability, including without limitation special, consequential or incidental damages. “Typical” parameters which may be provided in Prisemi data sheets and/or specifications can and do vary in different applications and actual performance may vary over time. All operating parameters, including “Typicals” must be validated for each customer application by customer’s technical experts. Prisemi does not convey any license under its patent rights nor the rights of others. The products listed in this document are designed to be used with ordinary electronic equipment or devices, Should you intend to use these products with equipment or devices which require an extremely high level of reliability and the malfunction of with would directly endanger human life (such as medical instruments, aerospace machinery, nuclear-reactor controllers, fuel controllers and other safety devices), please be sure to consult with our sales representative in advance.

Website: <http://www.prisemi.com>

For additional information, please contact your local Sales Representative.

©Copyright 2009, Prisemi Electronics

 **Prisemi**<sup>®</sup> is a registered trademark of Prisemi Electronics.

All rights are reserved.