

Features

- P-Channel, -5V Logic Level Control
- Very low on-resistance $R_{DS(on)}$ @ $V_{GS}=-4.5V$
- Fast Switching
- Enhancement mode
- 100% Avalanche Tested
- Pb-free lead plating; RoHS compliant



Part ID	Package Type	Marking	Tape and reel information
VSP007P06MS	PDFN5x6	007P06M	3000pcs/Reel

V_{DS}	-60	V
$R_{DS(on),TYP@ V_{GS}=-10V}$	8.0	m Ω
$R_{DS(on),TYP@ V_{GS}=-4.5V}$	10.0	m Ω
I_D	-80	A

PDFN5x6

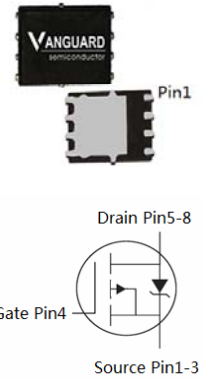

Maximum ratings, at $T_j=25^\circ\text{C}$, unless otherwise specified

Symbol	Parameter	Rating	Unit	
Common Ratings ($T_c=25^\circ\text{C}$ Unless Otherwise Noted)				
V_{GS}	Gate-Source Voltage	± 20	V	
$V_{(BR)DSS}$	Drain-Source Breakdown Voltage	-60	V	
T_j	Maximum Junction Temperature	175	$^\circ\text{C}$	
T_{STG}	Storage Temperature Range ^①	-55 to 175	$^\circ\text{C}$	
I_s	Diode Continuous Forward Current	$T_c=25^\circ\text{C}$ -80	A	
Mounted on Large Heat Sink				
I_D	Continuous Drain current @ $V_{GS}=-10V$	$T_c=25^\circ\text{C}$	-80	A
		$T_c=100^\circ\text{C}$	-51	A
I_{DM}	Pulse Drain Current Tested ^②	$T_c=25^\circ\text{C}$	-300	A
P_D	Maximum Power Dissipation	$T_c=25^\circ\text{C}$	115	W
$R_{\theta JC}$	Thermal Resistance-Junction to Case		1.3	$^\circ\text{C/W}$
$R_{\theta JA}$	Thermal Resistance Junction-Ambient		48	$^\circ\text{C/W}$
Drain-Source Avalanche Ratings				
EAS	Avalanche Energy, Single Pulsed ^③		56	mJ

Symbol	Parameter	Condition	Min.	Typ.	Max.	Unit
Static Electrical Characteristics @ T_J = 25°C (unless otherwise stated)						
V _{(BR)DSS}	Drain-Source Breakdown Voltage	V _{GS} =0V I _D =-250μA	-60	--	--	V
I _{DSS}	Zero Gate Voltage Drain Current(Tc=25°C)	V _{DS} =-60V,V _{GS} =0V	--	--	-1	μA
	Zero Gate Voltage Drain Current(Tc=125°C)	V _{DS} =-60V,V _{GS} =0V	--	--	-100	μA
I _{GSS}	Gate-Body Leakage Current	V _{GS} =±20V,V _{DS} =0V	--	--	±100	nA
V _{GS(TH)}	Gate Threshold Voltage	V _{DS} =V _{GS} ,I _D =-250μA	-1.0	-1.6	-2.5	V
R _{DS(ON)}	Drain-Source On-State Resistance ②	V _{GS} =-10V, I _D =-35A	--	8.0	10.0	mΩ
R _{DS(ON)}	Drain-Source On-State Resistance ②	V _{GS} =-4.5V, I _D =-10A	--	10.0	13.0	mΩ
Dynamic Electrical Characteristics @ T_J = 25°C (unless otherwise stated)						
C _{iss}	Input Capacitance	V _{DS} =-30V,V _{GS} =0V, f=1MHz	--	6985	--	pF
C _{oss}	Output Capacitance		--	450	--	pF
C _{rss}	Reverse Transfer Capacitance		--	290	--	pF
R _g	Gate Resistance	f=1MHz		13.8		Ω
Q _g	Total Gate Charge	V _{DS} =-30V,I _D =-20A, V _{GS} =-10V	--	94	--	nC
Q _{gs}	Gate-Source Charge		--	21	--	nC
Q _{gd}	Gate-Drain Charge		--	25	--	nC
Switching Characteristics						
t _{d(on)}	Turn-on Delay Time	V _{DD} =-30V, I _D =-5A, R _G =6.8Ω, V _{GS} =-10V	--	19	--	nS
t _r	Turn-on Rise Time		--	26	--	nS
t _{d(off)}	Turn-Off Delay Time		--	89	--	nS
t _f	Turn-Off Fall Time		--	45	--	nS
Source- Drain Diode Characteristics @ T_J = 25°C (unless otherwise stated)						
V _{SD}	Forward on voltage	I _{SD} =-35A,V _{GS} =0V	--	-0.88	-1.3	V
t _{rr}	Reverse Recovery Time	T _J =25°C,I _{sd} =-20A, V _{GS} =0V	--	35	--	nS
Q _{rr}	Reverse Recovery Charge	di/dt=-500A/μs		175		nC

NOTE:

① Repetitive rating; pulse width limited by max. junction temperature.

② Pulse width ≤ 300μs; duty cycle ≤ 2%.

③ Limited by T_{Jmax}, starting T_J = 25°C, L = 0.5mH,R_G = 25Ω, I_{AS} = -15A, V_{GS} = -10V. Part not recommended for use above this value

Typical Characteristics

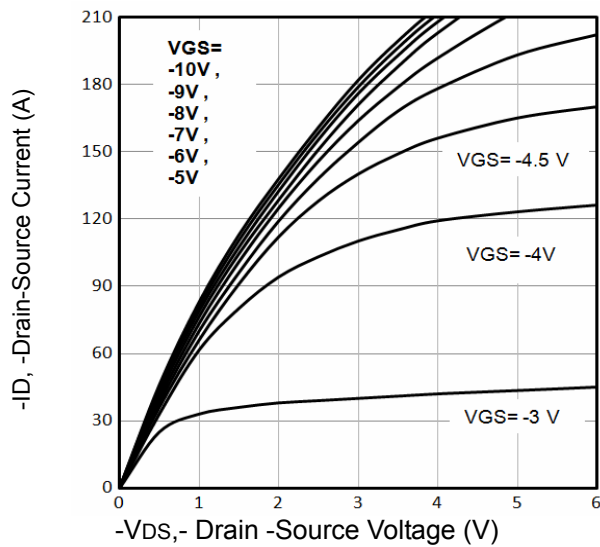

Fig1. Typical Output Characteristics

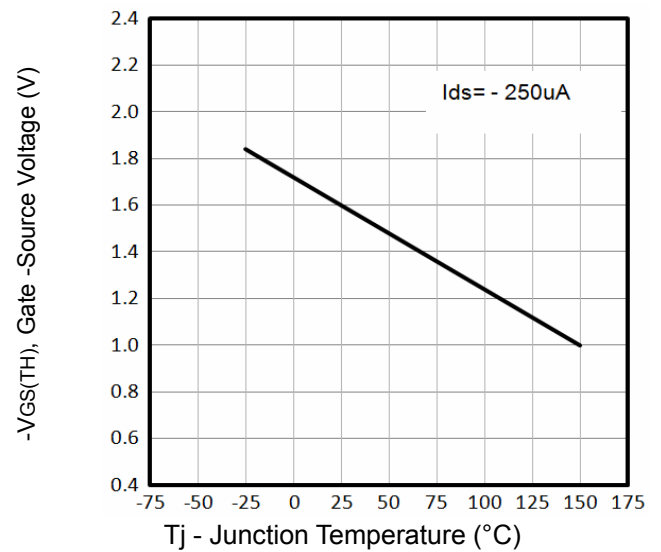

Fig2. Threshold Voltage Vs. Temperature

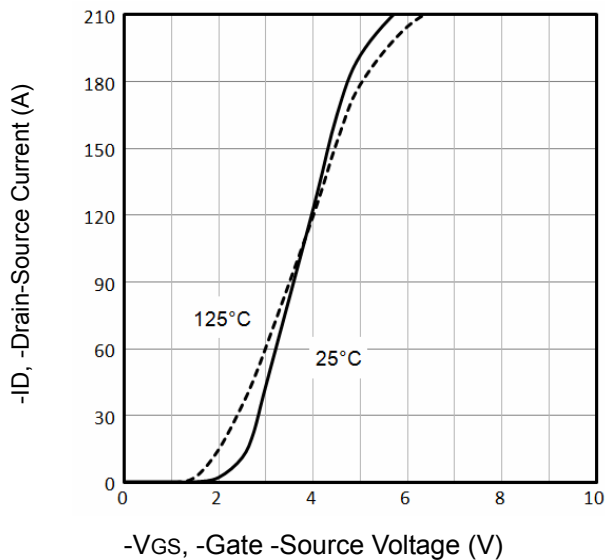

Fig3. Typical Transfer Characteristics

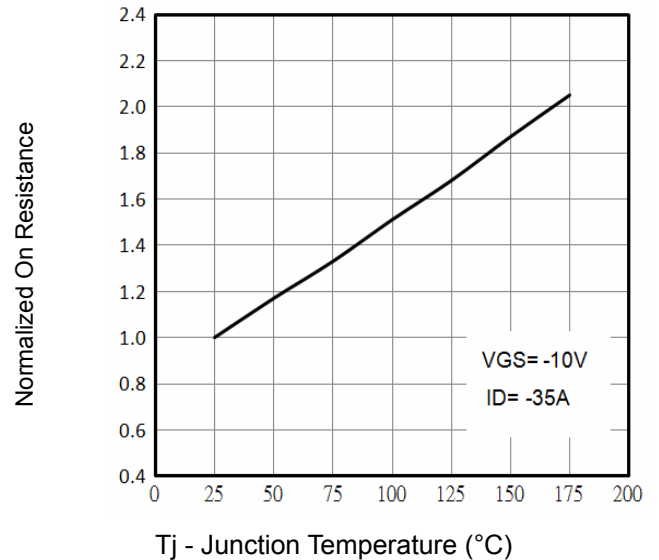

Fig4. Normalized On-Resistance Vs. Temperature

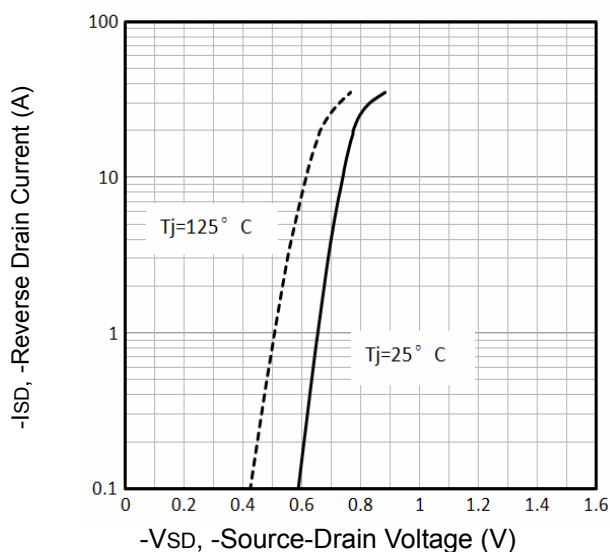

Fig5. Typical Source-Drain Diode Forward Voltage

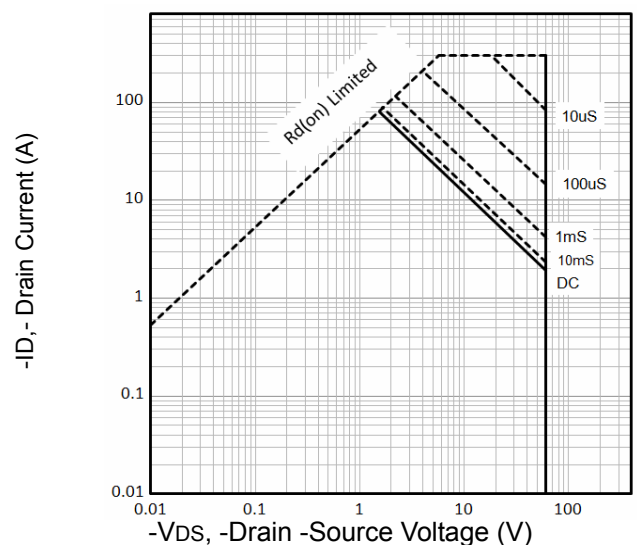

Fig6. Maximum Safe Operating Area

Typical Characteristics

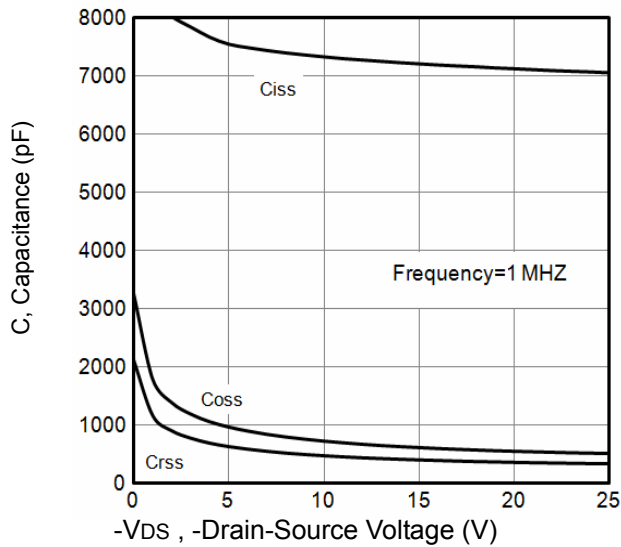

Fig7. Typical Capacitance Vs. Drain-Source Voltage

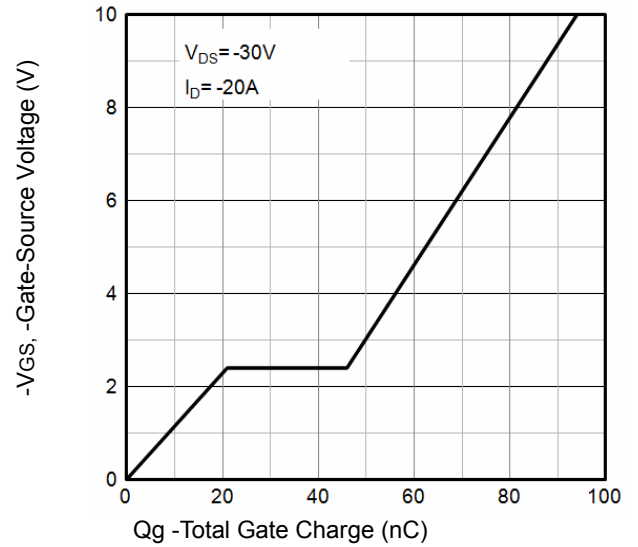

Fig8. Typical Gate Charge Vs. Gate-Source Voltage

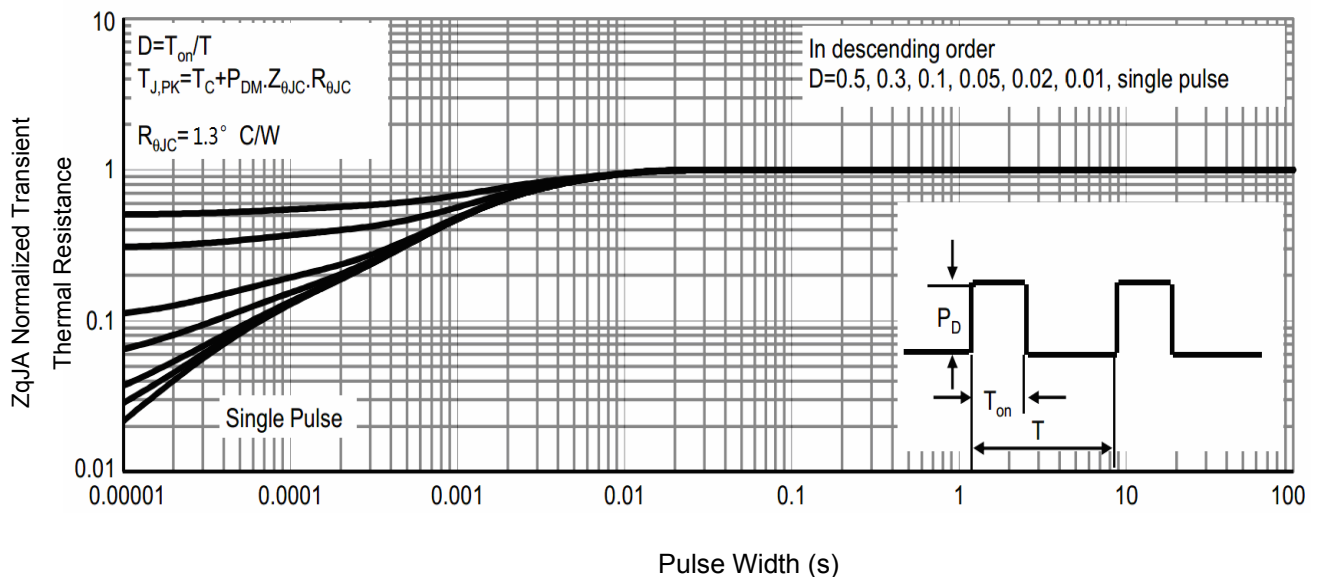

Fig9. Normalized Maximum Transient Thermal Impedance T_j -Junction

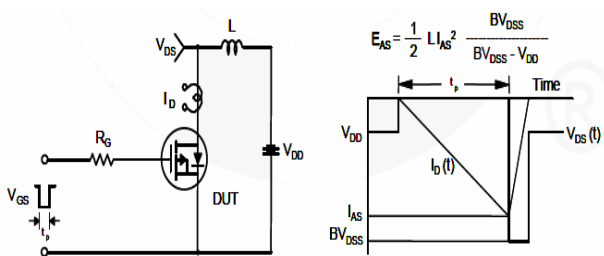

Fig10. Unclamped Inductive Test Circuit and Waveforms

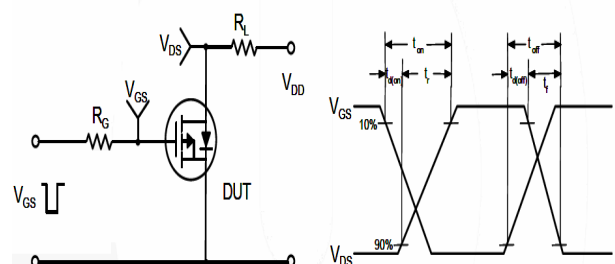
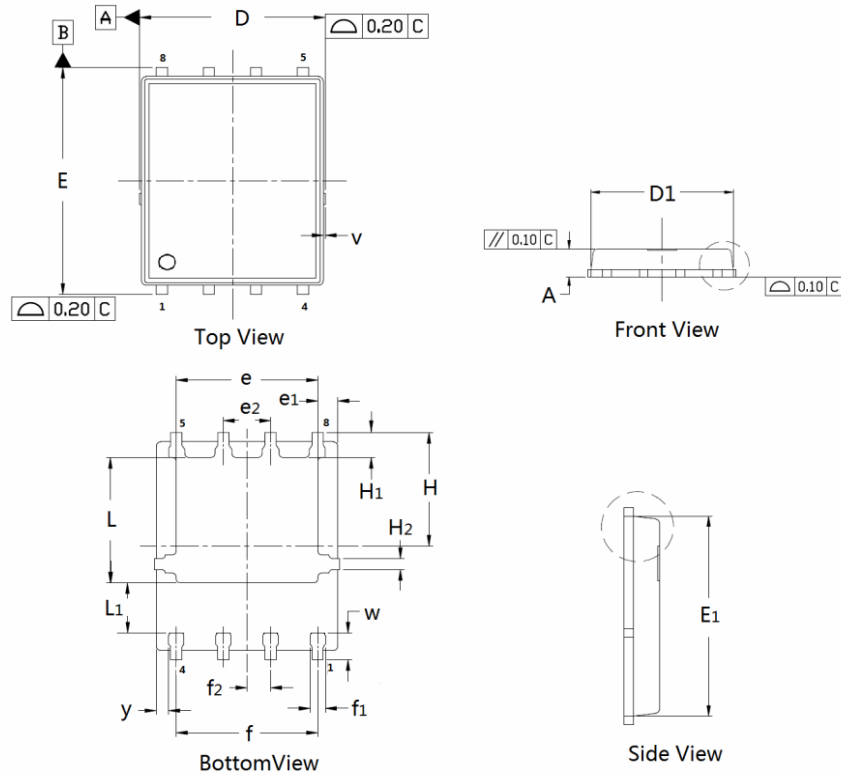

Fig11. Switching Time Test Circuit and waveforms

PDFN5×6 Package Outline Data



DIMENSIONS (unit : mm)

Symbol	Min	Typ	Max	Symbol	Min	Typ	Max
A	0.90	1.02	1.10	D	4.90	4.98	5.10
D ₁	4.80	4.89	5.00	E	6.00	6.11	6.20
E ₁	5.65	5.74	5.85	e	3.72	3.80	3.92
e ₁	--	0.54	--	e ₂	--	1.27	--
f	--	3.82	--	f ₁	0.31	0.37	0.51
f ₂	--	0.64	--	H	--	3.15	--
H ₁	0.59	0.63	0.79	H ₂	0.26	0.28	0.32
L	3.38	3.45	3.58	L ₁	--	1.39	--
v	--	0.13	--	w	0.64	0.68	0.84
y	--	0.34	--				

Customer Service

Sales and Service:

sales@vgsemi.com

Vanguard Semiconductor CO., LTD

TEL: (86-755) -26902410

FAX: (86-755) -26907027

WEB: www.vgsemi.com