

Transient Voltage Suppression Diodes Surface Mount – 5000W > 5SMDJ series

Descriptions

Transient Voltage Suppressors (TVS) are semiconductor devices designed to provide protection against over voltage transients. When over voltage events occur, the silicon TVS activates from an very high impedance status to a very low impedance status by operating in the avalanche mode and uses a large junction area to absorb large transient currents in a fast response time, protecting voltage sensitive electronics equipment from damaging.

JH supplies unipolar and bipolar TVS devices with axial and SMD packages, with maximum working voltage 5V to 550V, maximum power dissipation from 200W-5000W.

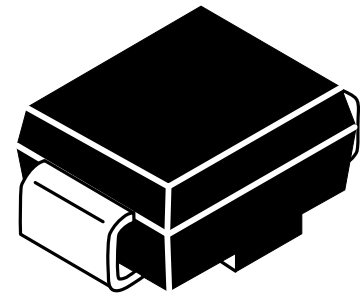

**SMC
(JEDEC DO-214AB)**

Features

- Glass passivated chip junction in SMC Package
- 5000W peak pulse power @10/1000 μ s
- Typical I_R less than 5 μ A above 13V
- Low incremental surge resistance
- Excellent clamping capability
- Typical failure mode is short from over-specified voltage / current
- Fast response time: typically less than 1.0ps from 0V to BV min
- IEC-61000-4-2 ESD 15kV(Air), 8kV (Contact)
- EFT protection of data lines in accordance with IEC 61000-4-4
- UL94V-0 Flammability Rating
- Halogen free and RoHS compliant

Order Information

Device	Qty per Box	Tape
5SMDJ series	500	7" Reel

Applications

- Telecom and Network
- Industrial Products
- Business Machines
- Vehicles Electronics
- Power Adapter
- Consumer Products
- Security Protection

Maximum Ratings and Thermal Characteristics (TA=25°C unless otherwise noted)

Parameter	Symbol	Value	Unit
Peak Pulse Power Dissipation by 10/1000 μ s Test Waveform	P_{PPM}	5000	W
Steady State Power Dissipation on Infinite Heat Sink at $T_L=75^\circ\text{C}$	P_D	6.5	W
Peak Forward Surge Current, 8.3ms Single Half Sine Wave Unidirectional Only ⁽¹⁾	I_{FSM}	300	A
Maximum Instantaneous Forward Voltage at 100A for Unidirectional Only ⁽²⁾	V_F	5.0	V
Operating Junction and Storage Temperature Range	T_J, T_{STG}	-55 to 150	$^\circ\text{C}$
Typical Thermal Resistance Junction to Lead	$R_{\theta JL}$	15	$^\circ\text{C/W}$
Typical Thermal Resistance Junction to Ambient	$R_{\theta JA}$	75	$^\circ\text{C/W}$

Notes:

1) Measured on 8.3ms single half sine wave or equivalent square wave, duty cycle=4 per minute maximum.

2) $V_F < 3.5\text{V}$ for devices of $V_{BR} \leq 200\text{V}$ and $V_F < 5.0\text{V}$ for devices of $V_{BR} \geq 201\text{V}$.

Electrical Characteristics (TA=25°C unless otherwise noted)

Type Number		V _{RMW}	I _R @V _{RMW}	V _{BR} @I _T (V)			I _T	V _C @I _{PP}	I _{PP} MAX
Uni	Bi	(V)	(μA)	Min	Nom	Max	(mA)	(V)	(A)
5SMDJ5.0A	5SMDJ5.0CA	5	800	6.4	6.7	7	10	9.2	543.5
5SMDJ6.0A	5SMDJ6.0CA	6	800	6.67	7.02	7.37	10	10.3	485.4
5SMDJ6.5A	5SMDJ6.5CA	6.5	500	7.22	7.6	7.98	10	11.2	446.4
5SMDJ7.0A	5SMDJ7.0CA	7	200	7.78	8.19	8.6	10	12	416.7
5SMDJ7.5A	5SMDJ7.5CA	7.5	100	8.33	8.77	9.21	1	12.9	387.6
5SMDJ8.0A	5SMDJ8.0CA	8	50	8.89	9.36	9.83	1	13.6	367.6
5SMDJ8.5A	5SMDJ8.5CA	8.5	20	9.44	9.92	10.4	1	14.4	347.2
5SMDJ9.0A	5SMDJ9.0CA	9	10	10	10.6	11.1	1	15.4	324.7
5SMDJ10A	5SMDJ10CA	10	5	11.1	11.7	12.3	1	17	294.1
5SMDJ11A	5SMDJ11CA	11	5	12.2	12.9	13.5	1	18.2	274.7
5SMDJ12A	5SMDJ12CA	12	5	13.3	14	14.7	1	19.9	251.3
5SMDJ13A	5SMDJ13CA	13	5	14.4	15.2	15.9	1	21.5	232.6
5SMDJ14A	5SMDJ14CA	14	5	15.6	16.4	17.2	1	23.2	215.5
5SMDJ15A	5SMDJ15CA	15	5	16.7	17.6	18.5	1	24.4	204.9
5SMDJ16A	5SMDJ16CA	16	5	17.8	18.8	19.7	1	26	192.3
5SMDJ17A	5SMDJ17CA	17	5	18.9	19.9	20.9	1	27.6	181.2
5SMDJ18A	5SMDJ18CA	18	5	20	21.1	22.1	1	29.2	171.2
5SMDJ20A	5SMDJ20CA	20	5	22.2	23.4	24.5	1	32.4	154.3
5SMDJ22A	5SMDJ22CA	22	5	24.4	25.7	26.9	1	35.5	140.8
5SMDJ24A	5SMDJ24CA	24	5	26.7	28.1	29.5	1	38.9	128.5
5SMDJ26A	5SMDJ26CA	26	5	28.9	30.4	31.9	1	42.1	118.8
5SMDJ28A	5SMDJ28CA	28	5	31.1	32.8	34.4	1	45.4	110.1
5SMDJ30A	5SMDJ30CA	30	5	33.3	35.1	36.8	1	48.4	103.3
5SMDJ33A	5SMDJ33CA	33	5	36.7	38.7	40.6	1	53.3	93.8
5SMDJ36A	5SMDJ36CA	36	5	40	42.1	44.2	1	58.1	86.1
5SMDJ40A	5SMDJ40CA	40	5	44.4	46.8	49.1	1	64.5	77.5
5SMDJ43A	5SMDJ43CA	43	5	47.8	50.3	52.8	1	69.4	72
5SMDJ45A	5SMDJ45CA	45	5	50	52.7	55.3	1	72.7	68.8
5SMDJ48A	5SMDJ48CA	48	5	53.3	56.1	58.9	1	77.4	64.6
5SMDJ51A	5SMDJ51CA	51	5	56.7	59.7	62.7	1	82.4	60.7
5SMDJ54A	5SMDJ54CA	54	5	60	63.2	66.3	1	87.1	57.4
5SMDJ58A	5SMDJ58CA	58	5	64.4	67.8	71.2	1	93.6	53.4
5SMDJ60A	5SMDJ60CA	60	5	66.7	70.2	73.7	1	96.8	51.7
5SMDJ64A	5SMDJ64CA	64	5	71.1	74.9	78.6	1	103	48.5
5SMDJ70A	5SMDJ70CA	70	5	77.8	81.9	86	1	113	44.2
5SMDJ75A	5SMDJ75CA	75	5	83.3	87.7	92.1	1	121	41.3
5SMDJ78A	5SMDJ78CA	78	5	86.7	91.3	95.8	1	126	39.7
5SMDJ85A	5SMDJ85CA	85	5	94.4	99.2	104	1	137	36.5
5SMDJ90A	5SMDJ90CA	90	5	100	105.5	111	1	146	34.2
5SMDJ100A	5SMDJ100CA	100	5	111	117	123	1	162	30.9
5SMDJ110A	5SMDJ110CA	110	5	122	128.5	135	1	177	28.2
5SMDJ120A	5SMDJ120CA	120	5	133	140	147	1	193	25.9
5SMDJ130A	5SMDJ130CA	130	5	144	151.5	159	1	209	23.9
5SMDJ150A	5SMDJ150CA	150	5	167	176	185	1	243	20.6
5SMDJ160A	5SMDJ160CA	160	5	178	187.5	197	1	259	19.3
5SMDJ170A	5SMDJ170CA	170	5	189	199	209	1	275	18.2
5SMDJ180A	5SMDJ180CA	180	5	201	211.5	222	1	290	17.2
5SMDJ200A	5SMDJ200CA	200	5	224	235.5	247	1	322	15.5
5SMDJ210A	5SMDJ210CA	210	5	233	251	269	1	339	14.7
5SMDJ220A	5SMDJ220CA	220	5	246	259	272	1	355	14.1

For bidirectional type having V_{RMW} of 10 volts and less, the I_R limit is double.

I-V Curve Characteristics

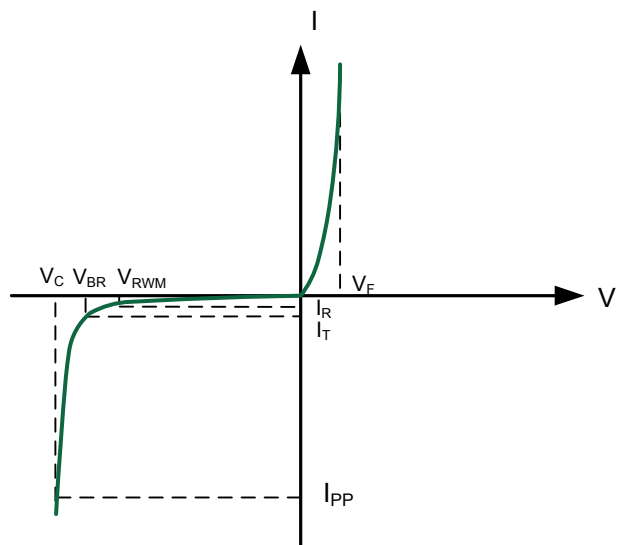

Uni-Directional TVS

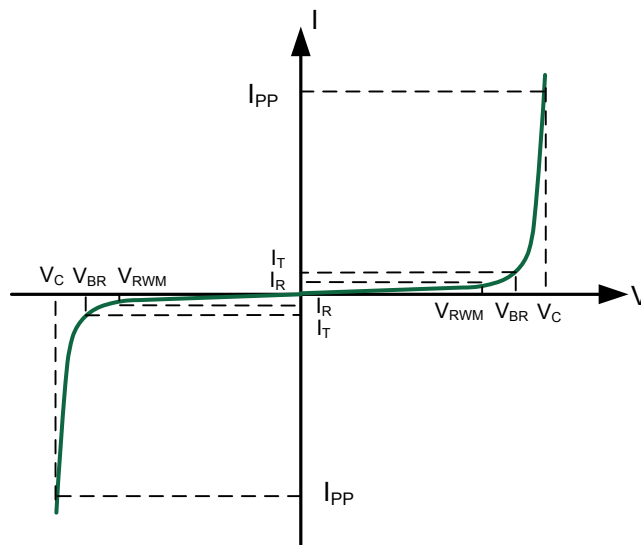

Bi-Directional TVS

V_{RWM} - Reverse Stand-Off Voltage - Working Peak Reverse Voltage

V_{BR} - Breakdown Voltage - Maximum current that flows through the TVS at a specified test current (I_T)

I_T - Test Current - Test Current

V_C - Clamping Voltage - Peak voltage measured across the suppressor at a specified I_{ppm} (peak impulse current)

I_{PP} - Peak Pulse Current - Maximum Reverse Peak Pulse Current

P_{PPM} - Peak Pulse Power Dissipation - Max power dissipation

I_R - Reverse Leakage Current - Current measured at V_{RWM}

V_F - Forward Voltage - Drop for Uni-directional

Ratings and Characteristic Curves (TA=25°C unless otherwise noted)

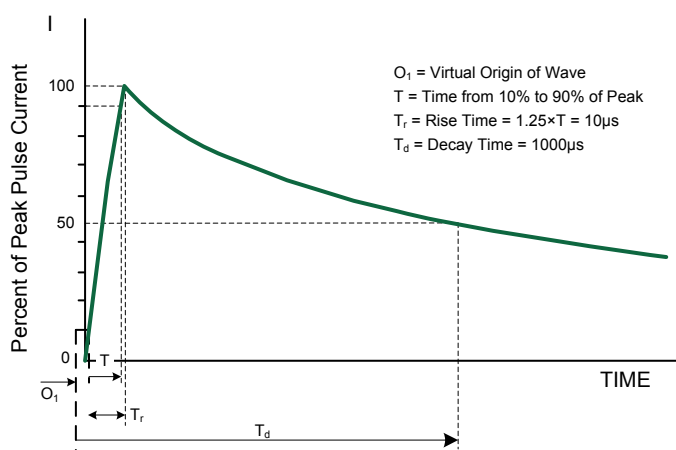

Pulse Waveform- 10/1000µs

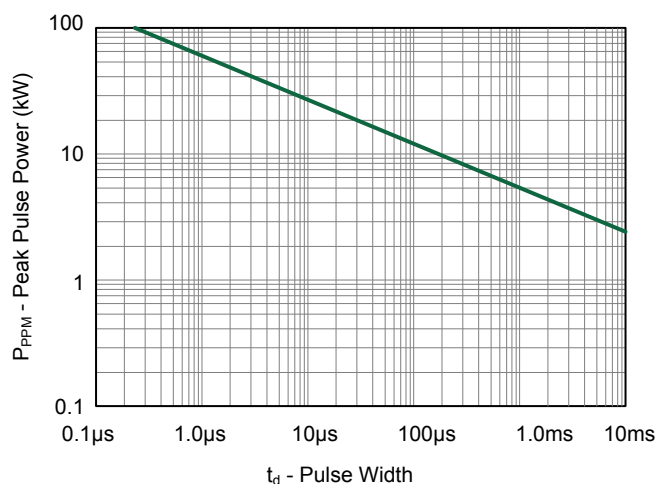

Peak Pulse Power Rating Curve

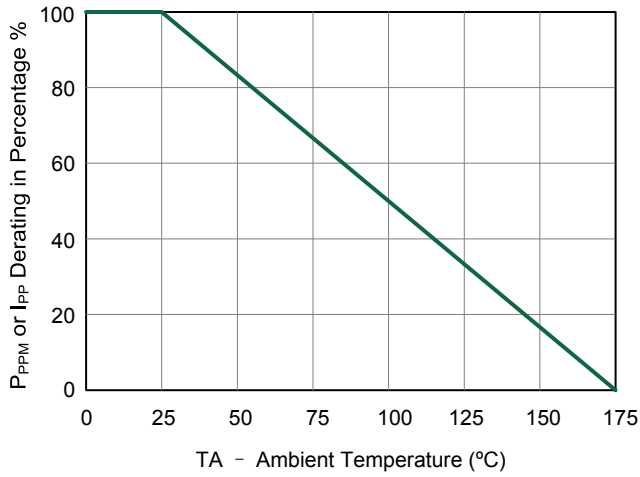

Pulse Derating Curve

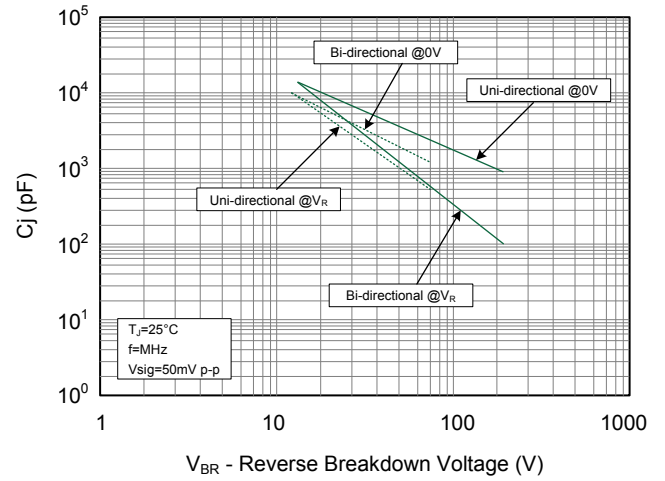

Typical Junction Capacitance

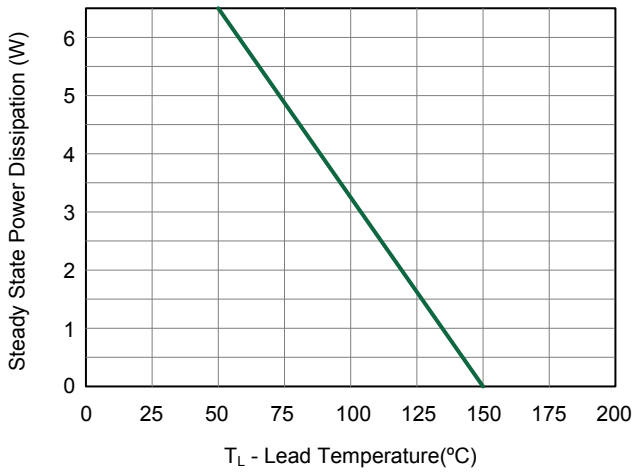

Steady State Power Derating Curve

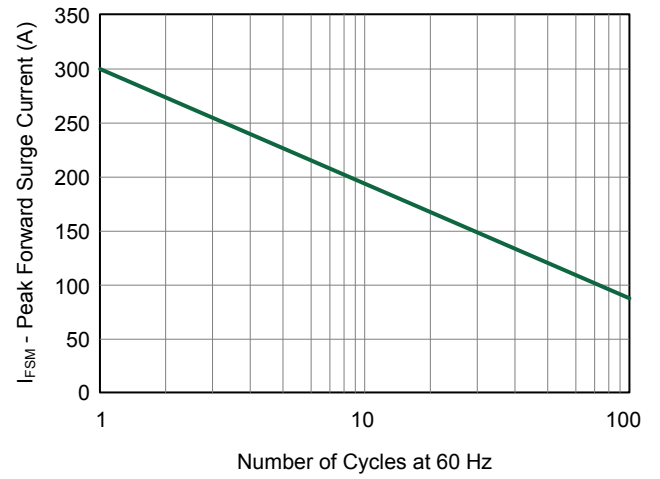

Maximum Non-Repetitive Peak Forward Surge Current Uni-Directional Only

Product Dimensions

Dimensions	Inches		Millimeters	
	Min	Max	Min	Max
A	0.114	0.126	2.900	3.200
B	0.260	0.280	6.600	7.110
C	0.220	0.245	5.590	6.220
D	0.079	0.103	2.060	2.620
E	0.030	0.060	0.760	1.520
F	-	0.008	-	0.203
G	0.205	0.320	7.750	8.130
H	0.006	0.012	0.152	0.305
I	0.129	-	3.300	-
J	0.094	-	2.400	-
K	-	0.165	-	4.200
L	0.094	-	2.400	-

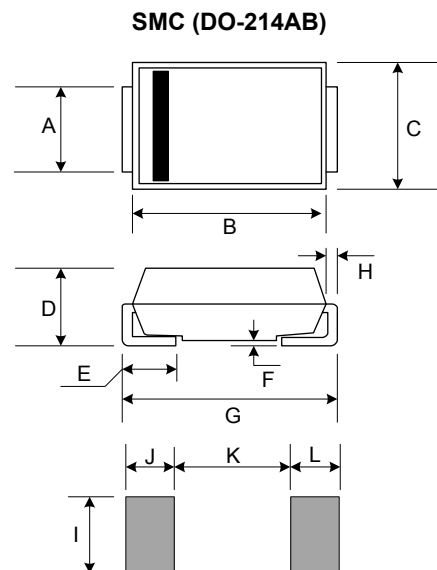

Soldering Parameters

Profile Feature	Lead-Free Assembly
Average Ramp-up Rate ($T_{S_{MAX}}$ to T_p) Average Ramp-down Rate (T_p to T_L)	3°C/second max. 6°C/second max.
Preheat • Temperature Min ($T_{S_{MIN}}$) • Temperature Max ($T_{S_{MAX}}$) • Time (t_s Preheat)	150°C 200°C 60-180 seconds
Time maintained above: • Temperature (T_L) • Time (t_L)	217°C 60-150 seconds
Peak/Classification Temperature • Temperature (T_p)	260 ^{+0/-5} °C
Time within 5°C of actual Peak Time (t_p)	20-40 seconds
Time 25°C to peak Temperature	8 minutes max
Do not exceed	280 °C

