



深圳市宏业兴电子有限公司

Shenzhen HongyeX Electronics Co.,Ltd.

文件编号 Document number:

HYSP-HL000XX

版本编码 Version number:

A2

# 产品规格书

## PRODUCT SPECIFICATION

客户名称

CUSTOMER

宏业产品系列

HBLS 系列叠层片式电感器

PRODUCT SERIES

HBLS SERIES MULTILAYER CHIP INDUCTOR

宏业规格型号

PRODUCT TYPE

客户型号规格

CUSTOMER'S PRODUCT TYPE

研发	品质	业务	批准

深圳市宏业兴电子有限公司 SHENZHEN HONGYEX ELECTRONICS CO.,LTD.

传真 Fax number: 0755-83295141

邮箱 Email: [hy@hongyex.com](mailto:hy@hongyex.com)

公司地址: 广东省深圳市福田区深南中路佳和大厦 A 座 23 层

Company address: 23/F,Block A,Jiahe building,Shenzhen City,Guangdong Province,China

工厂地址: 惠州市罗阳镇鸿达工业区五号宏业兴工业园

Factory address:Hongyexing Industrial Park, No.5, Hongda Industrial Zone,Luoyang Town,Huizhou City,Guangdong Province,China

备注 REMARK:

客户回签 CUSTOMER APPROVAL



深圳市宏业兴电子有限公司

Shenzhen HongyeX Electronics Co.,Ltd.

文件编号 Document number:

HYSP-HL000XX

版本编码 Version number:

A2

### 变更履历 Change list

序号 NO.	修改日期 DATE	修改内容 CHANGE CONTENT	版本号 Version NO.
1	2014.10.14	初版 First edition	A1
2	2019.11.29	更新联系方式 Update contact	A2

### 1 用途 APPLICATIONS

广泛应用于通信、影音设备、计算机、遥控等领域。

Widely use in Communications, Video and audio equipment, Computer, Remote control, etc.

### 2 特点 FEATURES

高可靠的一体化结构；

Monolithic structure for high reliability;

尺寸小；

Compact size inductor possible;

适用于各类表面贴装工艺；

Perfect shape for mounting with no directionality;

具有优异的可焊性和耐焊性。

Excellent solderability and high heat resistance for reflow soldering or wave soldering.

### 3 产品编码 PRODUCT IDENTIFICATION

HBLS    1005    -    10N    J

①            ②                    ③            ④

①	Type: Chip Ferrite Inductor
②	External Dimensions (L×W) (mm): 1.0×0.5
③	Nominal Inductance: 1N0, 1.0nH; 47N, 47nH; R10, 100nH
④	Inductance Tolerance: B, ±0.1nH; C, ±0.2nH; S, ±0.3nH; G, ±2%; H, ±3%; J, ±5%; K, ±10%;

### 4 外形及尺寸 SHAPE AND DIMENSIONS

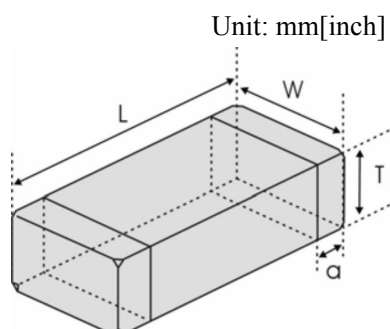

Type	L	W	T	a
HBLS0603 [0201]	0.6±0.05 [.024±.002]	0.3±0.05 [.012±.002]	0.3±0.05 [.012±.002]	0.12±0.05 [.005±.002]
HBLS1005 [0402]	1.0±0.15 [.039±.006]	0.5±0.15 [.020±.006]	0.5±0.15 [.020±.006]	0.25±0.1 [.010±.004]
HBLS1608 [0603]	1.6±0.15 [.063±.006]	0.8±0.15 [.031±.006]	0.8±0.15 [.031±.006]	0.3±0.2 [.012±.008]
	1.65±0.15 [.065±.006]			
HBLS2012 [0805]	2.0(+0.3,-0.1) [.079(+.012,-.004)]	1.25±0.2 [.049±.008]	0.85±0.2 [.033±.008]	0.5±0.3 [.020±.012]

### 5 特性参数 SPECIFICATIONS

详见附录 A。Please refer to Appendix A.

工作温度范围 Operating temperature range: -40℃~+85℃

储存温度范围 Storage temperature range: -10℃~+40℃, 70% RH.

## 6 测试及可靠性 TESTING AND RELIABILITY

### 6.1 测试环境条件 Test Conditions

一般按照以下环境条件测试（有特殊要求的除外），：

Unless otherwise specified, the standard atmospheric conditions for measurement/test as:

- a. 温度 Ambient Temperature: 20±15℃
- b. 湿度 Relative Humidity: 65±20%
- c. 大气压 Air Pressure: 86 kPa to 106 kPa

如果对测试结果有疑义，可以按照以下条件复测：

If any doubt on the results, measurements/tests should be made within the following limits:

- a. 温度 Ambient Temperature: 20±2℃
- b. 湿度 Relative Humidity: 65±5%
- c. 大气压 Air Pressure: 86kPa to 106 kPa

### 6.2 测试及可靠性 Testing and reliability

测试与可靠性 Testing and reliability	测试方法与要求 Test Methods and Remarks
直流电阻 RDC	标准值参考第 5 章节。Refer to Item 5. 测试仪器：高精度电阻表 HP4338B 或等效仪器。Test equipment (Analyzer): High Accuracy Milliohmmeter-HP4338B or equivalent.
电感量 Inductance (L)	a. 标准值参考第 5 章节。Refer to Item 5. b. 测试仪器：高精度射频阻抗分析仪 Anglient E4991A+HP16192A 或等效仪器。 Test equipment: High Accuracy RF Impedance /Material Analyzer -Anglient E4991A+ HP16192A or equivalent. c. 测试信号 Test signal: -40dBm or 100mV. d. 测试频率参考第 5 章节。Test frequency refers to Item 5.
额定电流 Rated Current (Ir)	a. 标准值参考第 5 章节。Refer to Item 5. b. 测试仪器：HP6632B 直流电源, Anglient E4991A+HP16192A+HP16200A 或等效仪器。 Test equipment: HP6632B system DC power supply, Anglient E4991A+HP16192A+HP16200A or equivalent.t. c. 额定直流电流下的电感量下降不超过 5%。The decreasing-rate of inductance value is within 5 %.
品质因数 Q	a. 标准值参考第 5 章节。Refer to Item 5. b. 测试仪器：高精度射频阻抗分析仪 Anglient E4991A+HP16192A 或等效仪器。 Test equipment: High Accuracy RF Impedance /Material Analyzer -Anglient E4991A+ HP16192A or equivalent. c. 测试信号 Test signal: -40dBm or 100mV. d. 测试频率参考第 5 章节。Test frequency refers to Item 5.
可焊性 SOLDER – ABILITY	至少 95%的焊接面完全被焊锡连续覆盖。95% min. coverage of all metabolised area. 焊锡温度 Solder temp. : 240±5℃ 浸入时间 Immersion time : 3±1 sec 焊锡 Solder : Sn-3Ag-0.5Cu
耐焊性 RESISTANCE TO SOLDER HEAT	无可见损伤。电特性和机械特性满足产品规范或检验标准要求。No visible damage. Electrical characteristics and mechanical characteristics shall be satisfied. 焊锡温度 Solder Temp. : 265±3℃ 浸入时间 Immersion time : 6±1 sec 预热 Preheating : 100℃ to 150℃, 1 minute. 在室温下放置 24±2 小时后测试检查。Measurement to be made after keeping at room temp for 24±2 hrs. 焊锡 Solder : Sn-3Ag-0.5Cu

<p>弯曲 Bend</p>	<p>试验后无破损现象，电感量应在±20%以内，直流电阻应符合标准/规范要求。 Without deformation cases, Inductance shall be satisfied ± 20%, DC resistance shall be satisfied. 将产品焊接在试验板上，如图所示在试验板中间位置施加压力，使得试验板中心点向下弯曲2mm，保持10秒。After soldering a chip to a test substrate, bend the substrate by 2mm hold for 10s and then return. Soldering shall be done in accordance with the recommended PC board pattern and reflow soldering.</p>	
<p>振动 Vibration</p>	<p>a. 试验要求 Performance specification 1) 外观 Appearance: 无可见机械损伤 no mechanical damage 2) 电感量变化应在±20%以内 Inductance shall be with ±20% of the initial value b. 试验条件 Test condition 1) 波形 Waveform: 正弦波 Sine wave 2) 频率 Frequency: 10~55~10 Hz 3) 持续时间 Sweep time: 1min 4) Amplitude: 1.5mm(peak-peak) 5. Direction: X, Y, Z (3 axes) 6. Duration: 2 hrs./axis, total 6 hrs.</p>	
<p>温度冲击 Temperature shock</p>	<p>a. 试验要求 Performance specification 1) 外观 Appearance: 无可见机械损伤 no mechanical damage 2) 电感量变化应在±20%以内 Inductance shall be with ±20% of the initial value b. 试验条件 Test condition 1) 温度 Temperature : -40℃, +85℃各保持30分钟。-40℃, +85℃ kept stabilized for 30 minutes each 2) 周期 Cycle: 5次。5 cycles. 3) 检查 Measurement: 试验后至少在室温条件下放置24小时以上。After placing at room ambient temperature for 24 hours minimum.</p>	
<p>湿热负载 HUMIDITY RESISTANCE</p>	<p>a. 试验要求 Performance specification 1) 外观 Appearance: 无可见机械损伤 no mechanical damage 2) 电感量变化应在±20%以内 Inductance shall be with ±20% of the initial value b. 试验条件 Test condition 1) 湿度 Humidity: 90 to 95 % RH 2) 温度 Temperature: 60±2℃ 3) 加载电流 Applied current: 额定直流电流 Rated current 4) 试验时间 Testing time: 1000 (+48,0) hours 5) 检查 Measurement: 试验后至少在室温条件下放置24小时以上。After placing at room ambient temperature for 24 hours minimum.</p>	
<p>高温负载 HIGH TEMPERATURE RESISTANCE</p>	<p>a. 试验要求 Performance specification 1) 外观 Appearance: 无可见机械损伤 no mechanical damage 2) 电感量变化应在±20%以内 Inductance shall be with ±20% of the initial value b. 试验条件 Test condition 1) 温度 Temperature: +85℃±2℃ 2) 加载电流 Applied current: 额定直流电流 Rated current 3) 试验时间 Testing time: 1000 (+48,0) hours 4) 检查 Measurement: 试验后至少在室温条件下放置24小时以上。After placing at room ambient temperature for 24 hours minimum.</p>	
<p>低温储存 LOW TEMPERATURE STORAGE LIFE</p>	<p>a. 试验要求 Performance specification 1) 外观 Appearance: 无可见机械损伤 no mechanical damage. 2) 电感量变化应在±20%以内 Inductance shall be with ±20% of the initial value. b. 试验条件 Test condition 1. 温度 Temperature: -40℃±2℃</p>	

	2. 试验时间 Testing time: 1000 (+48,0) hours 3. 检查 Measurement: 试验后至少在室温条件下放置 24 小时以上。After placing for 24 hours minimum at room ambient temperature.
端头强度 TERMINAL STRENGTH	无破损现象。Without deformation cases. 电感量变化应在±20%以内。Inductance shall be satisfied ± 20%. 直流电阻应满足标准要求。DC resistance shall be satisfied. 焊接在 PCB 上的产品应持续成熟 10N 推力共 10 秒; 0603[0201]产品推力为 2N。Solder chip on PCB and applied 10N(1.02Kgf) for 10 sec.0603[0201] chip applied 2N. <div style="text-align: right; margin-top: 10px;">  </div>
跌落 Drop	试验后产品应无失效现象。Products shall be no failure after test. 产品跌落在混凝土地面或钢板上。It shall be dropped on concrete or steel board. 试验方法: 自由落下。Method : free fall. 高度 Height : 100cm. 产品跌落方向: 3 个方向。Attitude from which the product is dropped : 3 direction. 总次数: 每个方向 3 次 (共 9 次)。The number of times : 3 times for each direction (Total 9 times).
盐雾 Salt mist	a. 试验要求 Performance specification 1) 外观 Appearance: 无可见机械损伤 no mechanical damage. 2) 电感量变化应在±20%以内 Inductance shall be with ±20% of the initial value. b. 试验条件 Test condition 1) 盐溶液溶度 Concentration of salt solution: (5±0.1) %. 2) PH: 6.5-7.2 3) 时间 Time: 48±2h

## 7 包装及储存 Packaging, Storage

### 7.1 包装 Packaging

#### (1) 载带尺寸 Tape Dimensions(Unit: mm)



Paper Tape				
型号 Type	A	B	P	Tmax
0603[0201]	0.4±0.1	0.7±0.1	2.0±0.05	0.55
1005[0402]	0.65±0.1	1.25±0.1	2.0±0.05	0.8
1608[0603]	1.0±0.2	1.8±0.2	4.0±0.1	1.1
2012[0805]	1.5±0.2	2.3±0.2	4.0±0.1	1.1
3216[1206]	1.9±0.2	3.5±0.2	4.0±0.1	1.1



EMbossed Tape					
型号 Type	A	B	P	Pmax	Tmax
2012[0805]	1.55±0.2	2.25±0.2	4.0±0.1	1.45	0.3
3216[1206]	1.88±0.2	3.5±0.2	4.0±0.1	1.27	0.3
3225[1210]	2.9±0.2	3.5±0.2	4.0±0.1	1.55	0.28
4532[1812]	3.66±0.2	4.95±0.2	4.0±0.1	1.85	0.33

#### (2) 载带 Tape

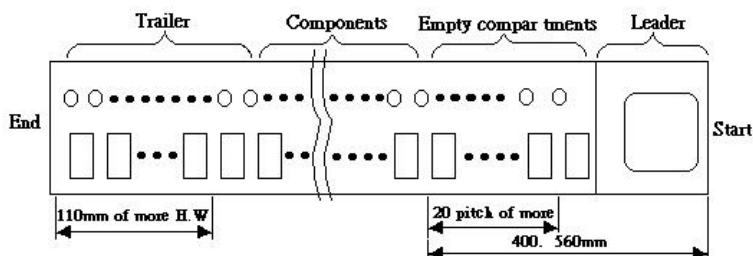

### (3) 卷盘 REEL



型号 Type	T(mm)	载带 Tape	数量 Quantity
0603[0201]	0.3 $\pm$ 0.05	Paper Tape	10K
1005[0402]	0.5 $\pm$ 0.15	Paper Tape	10K
1608[0603]	0.8 $\pm$ 0.15	Paper Tape	4K
2012[0805]	0.85 $\pm$ 0.2	Paper Tape	4K
	1.25 $\pm$ 0.2	Embossed Tape	3K
3216[1206]	0.85 $\pm$ 0.2	Paper Tape	4K
	1.1 $\pm$ 0.2	Embossed Tape	3K
3225[1210]	1.3 $\pm$ 0.3	Embossed Tape	2K
4532[1812]	1.5 $\pm$ 0.3	Embossed Tape	1K

### (4) 剥离力 PEELING OFF FORCE



剥离速度 Speed of peeling off	300mm/s
剥离力 Peeling off force	0.1N to 1N(10g to 100g).

### (5) 包装 Packaging

- 卷盘和干燥剂一同放入尼龙或塑料袋中。Reel and a bag of desiccant shall be packed in Nylon or plastic bag.
- 每个内盒中最多装 2 个上述袋子。Maximum of 2 bags shall be packaged in a inner box.
- 每个外箱中最多装 8 个内盒。Maximum of 8 inner box shall be packaged in a outer box.

### 7.2 储存 Storage

7.2.1 不得暴露在高温高湿环境下储存，否则导致产品外电极和焊接性恶化变差。建议包装好的产品储存

在低于 40°C、小于 70% RH 条件下。The solderability of the external electrode may be deteriorated if packages are stored where they are exposed to high humidity. Packages must be stored at 40°C or less and 70% RH or less.

7.2.2 不得暴露在灰尘或腐蚀性气体（如氯化氢，亚硫酸气体或硫化氢等）环境下储存，否则会导致产品外电极和焊接性恶化变差。The solderability of the external electrode may be deteriorated if packages are stored where they are exposed to dust or harmful gas (hydrogen chloride, sulfurous acid gas or hydrogen sulfide).

7.2.3 如果暴露在阳光直射或加热环境下储存，会导致包装材料变形。Packaging material may be deformed if packages are stored where they are exposed to heat or direct sunlight.

7.2.4 采用聚乙烯热封载带形式的最小包装，在使用之前不要拆开。如果拆开了，应尽快使用卷盘保护起来。Minimum packages, such as polyvinyl heat-seal packages shall not be opened until just before they are used.If opened, use the reels as soon as possible.

7.2.5 在符合 8.2.1 和 8.2.2 要求的环境下储存，从产品发货日期开始 6 个月内，产品的焊接性能够满足 7.2 规定的要求。Solderability specified in composite specification 7.2 shall be for 6 months from the date of delivery on condition that they are stored at the environment specified clause 8.2.1 & 8.2.2.

在产品使用之前，如果储存期超过 6 个月，则需要复检焊接性。For those parts which passed more than 6 months shall be checked solderability before it is used.

## 8 安装使用及注意事项

### 8.1 回流焊条件 Reflow soldering conditions

焊接之前产品应预热到 150°C。焊接后应冷却到 100°C。Pre-heating should be in such a way that the temperature difference between solder and ferrite surface is limited to 150°C max.Also cooling into solvent after soldering should be in such a way that the temperature difference is limited to 100°C max.

如果预热不充分，会导致产品质量恶化。Unenough pre-heating may cause cracks on the ferrite, resulting in the deterioration of product quality.

产品应当按照下述曲线焊接。Products should be soldered within the following allowable range indicated by the slanted line.

作业前，应对焊锡炉进行校准确认，保证能够符合焊接工艺条件。The excessive soldering conditions may cause the corrosion of the electrode, When soldering is repeated, allowable time is the accumulated time.



Temperature Profile



A	Slope of temp. rise	※ 1 to 5	※ °C/sec
B	Heat time	50 to 150	※ sec
	Heat temperature	120 to 180	※ °C
C	Slope of temp. rise	1 to 5	※ °C/sec
D	Time over 230°C	90~120	※ sec
E	Peak temperature	255~260	※ °C
	Peak hold time	10 max.	※ sec
※ No. of mounting		3	※ times



### 8.2 返工 Reworking with soldering iron

预热 Preheating	150°C, 1 minute
最高温度 Tip temperature	280°C max
焊接时间 Soldering time	3seconds max.
电烙铁输出功率 Soldering iron output	30w max.
电烙铁焊头尺寸 End of soldering iron	φ 3mm max.

\*返工仅限一次。Reworking should be limited to only one time.

注意 Note: 为了避免焊接高温冲击导致产品本体开裂，电烙铁焊头焊锡时应避免直接与产品接触。Do not directly touch the products with the tip of the soldering iron in order to prevent the crack on the ferrite material due to the thermal shock.

### 8.3 焊料量 Solder Volume

焊料使用时，不得超过如下所示的上限要求。Solder shall be used not to be exceed the upper limits as shown below.



随着焊料的增加，产品承受的机械应力也随之增加。过量的焊料所产生的机械应力，会导致产品出现机械或电气特性失效。Accordingly increasing the solder volume, the mechanical stress to product is also increased. Exceeding solder volume may cause the failure of mechanical or electrical performance.



# 深圳市宏业兴电子有限公司

Shenzhen HongyeX Electronics Co.,Ltd.

文件编号 Document number:

HYSP-HL000XX

版本编码 Version number:

A2

## 附录 A 电气特性表

### Appendix A Electrical Characteristics

#### HBLS0603 Series

Part Number	Inductance	Mini. Quality Factor	L,Q test Freq.	Typical Q@Freq.(GHz)					Mini.self resonant frequency	Max.DC resistance	Max. rated Current	Thickness
				0.5	0.8	1.8	2.0	2.4				
Unit	nH	-	MHz	-					MHz	Ω	mA	mm [inch]
Symbol	L	Q	Freq.	Q					S.R.F	DCR	Ir	T
HBLS0603-0N6□	0.6	13	500	>24	>32	>54	>57	>65	10000	0.06	600	0.3±0.05 [.012±.002]
HBLS0603-0N7□	0.7	13	500	>24	>32	>54	>57	>65	10000	0.06	550	
HBLS0603-0N8□	0.8	13	500	>24	>32	>54	>57	>65	10000	0.07	550	
HBLS0603-0N9□	0.9	13	500	>24	>32	>54	>57	>65	10000	0.07	550	
HBLS0603-1N0□	1	13	500	24	32	54	57	65	10000	0.08	520	
HBLS0603-1N1□	1.1	13	500	19	26	45	47	55	10000	0.11	440	
HBLS0603-1N2□	1.2	13	500	19	25	43	44	52	10000	0.12	420	
HBLS0603-1N3□	1.3	13	500	19	25	40	42	47	10000	0.12	420	
HBLS0603-1N4□	1.4	13	500	19	24	39	41	47	10000	0.11	440	
HBLS0603-1N5□	1.5	13	500	19	24	39	41	46	10000	0.12	420	
HBLS0603-1N6□	1.6	13	500	19	24	39	41	46	10000	0.13	410	
HBLS0603-1N7□	1.7	13	500	19	24	39	41	46	10000	0.15	380	
HBLS0603-1N8□	1.8	13	500	19	24	39	41	46	10000	0.15	380	
HBLS0603-1N9□	1.9	13	500	18	24	38	40	45	10000	0.18	350	
HBLS0603-2N0□	2	13	500	17	24	38	39	44	10000	0.23	300	
HBLS0603-2N1□	2.1	13	500	17	24	37	39	44	10000	0.24	300	
HBLS0603-2N2□	2.2	13	500	17	24	38	40	43	10000	0.25	290	
HBLS0603-2N3□	2.3	13	500	17	24	37	39	43	10000	0.2	330	
HBLS0603-2N4□	2.4	13	500	17	23	36	38	42	10000	0.22	310	
HBLS0603-2N5□	2.5	13	500	17	23	35	36	40	9600	0.2	330	
HBLS0603-2N6□	2.6	13	500	17	22	34	35	39	9400	0.2	330	
HBLS0603-2N7□	2.7	13	500	17	22	34	35	39	9200	0.22	310	
HBLS0603-2N8□	2.8	13	500	17	22	34	35	39	8900	0.24	300	
HBLS0603-2N9□	2.9	13	500	17	22	34	35	39	8800	0.26	280	
HBLS0603-3N0□	3	13	500	17	22	34	35	39	8600	0.26	280	
HBLS0603-3N1□	3.1	13	500	17	22	34	35	39	8500	0.28	270	
HBLS0603-3N2□	3.2	13	500	17	22	33	35	39	8200	0.28	270	
HBLS0603-3N3□	3.3	13	500	18	23	34	36	40	8100	0.3	270	
HBLS0603-3N4□	3.4	13	500	17	23	33	35	39	8000	0.3	270	



# 深圳市宏业兴电子有限公司

Shenzhen HongyeX Electronics Co.,Ltd.

文件编号 Document number:

HYSP-HL000XX

版本编码 Version number:

A2

HBSL0603-3N5□	3.5	13	500	17	23	33	35	39	7900	0.34	250	0.3±0.05 [.012±.002]
HBSL0603-3N6□	3.6	13	500	16	23	33	35	39	7700	0.38	240	
HBSL0603-3N7□	3.7	13	500	16	23	33	35	38	7600	0.4	230	
HBSL0603-3N8□	3.8	13	500	16	22	33	35	38	7500	0.42	230	
HBSL0603-3N9□	3.9	13	500	16	22	33	35	38	7400	0.42	230	
HBSL0603-4N3□	4.3	13	500	16	21	32	34	37	6800	0.44	220	
HBSL0603-4N7□	4.7	13	500	16	22	33	35	38	6200	0.45	220	
HBSL0603-5N1□	5.1	13	500	17	22	34	36	38	5900	0.46	210	
HBSL0603-5N6□	5.6	13	500	16	21	33	34	37	5500	0.46	210	
HBSL0603-6N2□	6.2	13	500	18	23	34	35	37	5100	0.48	210	
HBSL0603-6N8□	6.8	13	500	17	22	32	33	35	4900	0.5	200	
HBSL0603-7N5□	7.5	13	500	16	21	31	33	34	4700	0.5	200	
HBSL0603-8N2□	8.2	13	500	16	21	31	32	34	4300	0.56	190	
HBSL0603-9N1□	9.1	13	500	16	20	30	31	32	4100	0.72	170	
HBSL0603-10N□	10	13	500	16	20	28	29	31	3800	0.8	160	
HBSL0603-12N□	12	13	500	16	20	27	28	28	3400	0.8	160	
HBSL0603-15N□	15	13	500	15	19	24	24	23	2600	0.85	160	
HBSL0603-18N□	18	13	500	15	19	23	24	22	2300	1	140	
HBSL0603-22N□	22	13	500	15	19	22	23	20	1900	1.2	130	
HBSL0603-27N□	27	13	500	15	19	15	13	8	1800	1.6	120	
HBSL0603-33N□	33	11	300	14	15	8	5	-	1800	2.2	110	
HBSL0603-39N□	39	11	300	14	15	6	-	-	1600	2.3	100	
HBSL0603-47N□	47	11	300	14	15	-	-	-	1500	2.6	100	
HBSL0603-56N□	56	11	300	13	13	-	-	-	1400	2.8	80	
HBSL0603-68N□	68	11	300	13	11	-	-	-	1200	3.2	80	
HBSL0603-82N□	82	10	300	12	10	-	-	-	1100	3.8	70	
HBSL0603-R10□	100	10	300	12	10	-	-	-	1000	4	60	
HBSL0603-R12□	120	9	300	12	8	-	-	-	1000	5	50	

\*请选用时注明公差 (B, ±0.1nH; C, ±0.2nH; S, ±0.3nH; G, ±2%; H, ±3%; J, ±5%; K, ±10%) Please specify the inductance tolerance code(B, ±0.1nH; C, ±0.2nH; S, ±0.3nH; G, ±2%; H, ±3%; J, ±5%; K, ±10%).

## HBSL1005 Series

Part Number	Inductance	Mini. Quality Factor	L,Q test frequency	Typical Q@Freq.(MHz)			Mini.self resonant frequency	Max.DC resistance	Max.rate d Current	Thickness
				100	800	1000				
Unit	nH	-	MHz	-			MHz	Ω	mA	mm [inch]
Symbol	L	Q	Freq.	Q			S.R.F	DCR	Ir	T
HBSL1005-1N0S	1.0±0.3	8	100	11	34	36	10000	0.1	400	0.5±0.15



# 深圳市宏业兴电子有限公司

Shenzhen HongyeX Electronics Co.,Ltd.

文件编号 Document number:

HYSP-HL000XX

版本编码 Version number:

A2

HBL51005-1N1S	1.1±0.3	8	100	11	34	36	10000	0.1	400	[.020±.006 ]
HBL51005-1N2S	1.2±0.3	8	100	11	34	36	10000	0.1	400	
HBL51005-1N3S	1.3±0.3	8	100	11	34	36	10000	0.1	400	
HBL51005-1N5S	1.5±0.3	8	100	11	34	36	6000	0.1	300	
HBL51005-1N6S	1.6±0.3	8	100	11	32	35	6000	0.1	300	
HBL51005-1N8S	1.8±0.3	8	100	11	30	34	6000	0.1	300	
HBL51005-2N0S	2.0±0.3	8	100	10	29	33	6000	0.2	300	0.5±0.15 [.020±.006 ]
HBL51005-2N2S	2.2±0.3	8	100	10	29	33	6000	0.2	300	
HBL51005-2N4S	2.4±0.3	8	100	10	29	32	6000	0.2	300	
HBL51005-2N7S	2.7±0.3	8	100	10	29	32	6000	0.2	300	
HBL51005-3N0S	3.0±0.3	8	100	10	29	32	6000	0.2	300	
HBL51005-3N3S	3.3±0.3	8	100	10	29	32	6000	0.2	300	
HBL51005-3N6S	3.6±0.3	8	100	10	28	31	4000	0.2	300	
HBL51005-3N9S	3.9±0.3	8	100	10	28	31	4000	0.2	300	
HBL51005-4N3S	4.3±0.3	8	100	10	28	31	4000	0.2	300	
HBL51005-4N7S	4.7±0.3	8	100	10	28	31	4000	0.2	300	
HBL51005-5N1S	5.1±0.3	8	100	10	28	30	4000	0.3	300	
HBL51005-5N6S	5.6±0.3	8	100	10	28	30	4000	0.3	300	
HBL51005-6N2S	6.2±0.3	8	100	10	27	30	3900	0.3	300	
HBL51005-6N8□	6.8	8	100	10	27	30	3900	0.3	300	
HBL51005-7N5□	7.5	8	100	10	27	30	3700	0.4	300	
HBL51005-8N2□	8.2	8	100	10	27	30	3600	0.4	300	
HBL51005-9N1□	9.1	8	100	10	27	30	3400	0.4	300	
HBL51005-10N□	10	8	100	10	27	30	3200	0.4	300	
HBL51005-12N□	12	8	100	10	26	29	2700	0.5	300	
HBL51005-15N□	15	8	100	10	26	28	2300	0.5	300	
HBL51005-18N□	18	8	100	10	25	27	2100	0.6	300	
HBL51005-20N□	20	8	100	10	25	26	2000	0.6	300	
HBL51005-22N□	22	8	100	10	25	25	1900	0.6	300	
HBL51005-27N□	27	8	100	10	25	23	1600	0.7	300	
HBL51005-33N□	33	8	100	10	22	22	1300	0.8	200	
HBL51005-39N□	39	8	100	10	22	19	1200	1	200	
HBL51005-43N□	43	8	100	10	21	16	1100	1.1	200	
HBL51005-47N□	47	8	100	10	21	16	1000	1.1	200	
HBL51005-56N□	56	8	100	10	18	13	750	1.2	200	
HBL51005-68N□	68	8	100	10	18	9	750	1.4	180	
HBL51005-82N□	82	8	100	10	13	-	750	2.4	150	
HBL51005-R10□	100	8	100	10	12	-	700	2.6	150	
HBL51005-R12□	120	8	100	10	-	-	600	2.8	150	
HBL51005-R15□	150	8	100	10	-	-	550	3.2	100	



# 深圳市宏业兴电子有限公司

Shenzhen HongyeX Electronics Co.,Ltd.

文件编号 Document number:

HYSP-HL000XX

版本编码 Version number:

A2

HBLS1005-R18□	180	8	100	10	-	-	500	3.7	100
HBLS1005-R22□	220	8	100	12	-	-	450	4	100
HBLS1005-R27□	270	8	100	12	-	-	400	4.5	100
HBLS1005-R33□	330	6	50	-	-	-	350	7	50

\*请选用时注明公差 (B, ±0.1nH; C, ±0.2nH; S, ±0.3nH; G, ±2%; H, ±3%; J, ±5%; K, ±10%) Please specify the inductance tolerance code(B, ±0.1nH; C, ±0.2nH; S, ±0.3nH; G, ±2%; H, ±3%; J, ±5%; K, ±10%).

## HBLS1608 Series

Part Number	Inductance	Mini. Quality Factor	L,Q test frequency	Typical Q@Freq.(MHz)			Mini.self resonant frequency	Max.DC resistance	Max.rated Current	Thichness
				100	800	1000				
Unit	nH	-	MHz	-			MHz	Ω	mA	mm [inch]
Symbol	L	Q	Freq.	Q			S.R.F	DCR	Ir	T
HBLS1608-1N0S	1.0±0.3	8	100	13	70	80	10000	0.05	500	0.8±0.15 [.031±.006]
HBLS1608-1N2S	1.2±0.3	8	100	13	60	70	10000	0.05	500	
HBLS1608-1N5S	1.5±0.3	8	100	13	47	68	6000	0.1	500	
HBLS1608-1N8S	1.8±0.3	8	100	13	45	61	6000	0.1	500	
HBLS1608-2N2S	2.2±0.3	8	100	13	45	60	6000	0.1	500	
HBLS1608-2N7S	2.7±0.3	10	100	13	44	55	6000	0.12	500	
HBLS1608-3N3S	3.3±0.3	10	100	13	43	50	6000	0.15	500	
HBLS1608-3N9S	3.9±0.3	10	100	13	43	50	6000	0.16	500	
HBLS1608-4N7S	4.7±0.3	10	100	13	43	50	6000	0.2	500	
HBLS1608-5N6S	5.6±0.3	10	100	14	42	48	5000	0.25	500	
HBLS1608-6N8□	6.8	10	100	14	43	50	5000	0.3	500	
HBLS1608-8N2□	8.2	10	100	14	43	48	4500	0.35	500	
HBLS1608-10N□	10	12	100	15	45	50	3500	0.4	300	
HBLS1608-12N□	12	12	100	18	48	50	3000	0.45	300	
HBLS1608-15N□	15	12	100	18	48	50	2300	0.5	300	
HBLS1608-18N□	18	12	100	16	48	51	2200	0.55	300	
HBLS1608-22N□	22	12	100	16	45	48	2000	0.6	300	
HBLS1608-27N□	27	12	100	16	45	45	1700	0.65	300	
HBLS1608-33N□	33	12	100	16	45	41	1500	0.7	300	
HBLS1608-39N□	39	12	100	17	40	48	1400	0.7	300	
HBLS1608-47N□	47	12	100	17	35	35	1200	0.7	300	
HBLS1608-56N□	56	12	100	17	35	30	1100	0.75	300	
HBLS1608-68N□	68	12	100	17	30	20	900	0.85	300	
HBLS1608-82N□	82	8	100	15	22	-	800	1	300	
HBLS1608-R10□	100	8	100	15	16	-	700	1.2	300	



# 深圳市宏业兴电子有限公司

Shenzhen HongyeX Electronics Co.,Ltd.

文件编号 Document number:

HYSP-HL000XX

版本编码 Version number:

A2

HBLS1608-R12□	120	8	50	15	-	-	600	1.4	200
HBLS1608-R15□	150	8	50	15	-	-	500	1.6	200
HBLS1608-R18□	180	8	50	15	-	-	400	1.9	200
HBLS1608-R22□	220	8	50	15	-	-	350	2.4	200
HBLS1608-R27□	270	8	50	16	-	-	350	2.6	150
HBLS1608-R33□	330	8	50	16	-	-	350	2.8	150
HBLS1608-R39□	390	8	50	16	-	-	300	3.2	150
HBLS1608-R43□	430	8	50	16	-	-	280	3.4	150
HBLS1608-R47□	470	8	50	15	-	-	250	3.6	150
HBLS1608-R56□	560	8	50	15	-	-	250	4	100
HBLS1608-R68□	680	8	50	15	-	-	250	4.5	100

\*请选用时注明公差 (B, ±0.1nH; C, ±0.2nH; S, ±0.3nH; G, ±2%; H, ±3%; J, ±5%; K, ±10%) Please specify the inductance tolerance code(B, ±0.1nH; C, ±0.2nH; S, ±0.3nH; G, ±2%; H, ±3%; J, ±5%; K, ±10%).

## HBLS2012 Series

Part Number	Inductance	Mini. Quality Factor	L,Q test frequency	Mini.self resonant frequency	Max.DC resistance	Max.rated Current	Thichness
Unit	μH	-	MHz	MHz	Ω	mA	Mm [inch]
Symbol	L	Q	Freq.	S.R.F	DCR	Ir	T
HBLS2012-1N0□	1	10	100	>3000	0.1	600	0.85±0.20
HBLS2012-1N5□	1.5	10	100	>3000	0.1	600	
HBLS2012-1N8□	1.8	10	100	>3000	0.1	600	
HBLS2012-2N2□	2.2	10	100	>3000	0.1	600	
HBLS2012-2N7□	2.7	10	100	>3000	0.1	600	
HBLS2012-3N3□	3.3	10	100	>3000	0.13	600	
HBLS2012-3N9□	3.9	10	100	>3000	0.15	600	
HBLS2012-4N7□	4.7	10	100	>3000	0.2	400	
HBLS2012-5N6□	5.6	10	100	>3000	0.23	400	
HBLS2012-6N8□	6.8	10	100	>3000	0.25	400	
HBLS2012-8N2□	8.2	10	100	>3000	0.28	400	
HBLS2012-10N□	10	10	100	2500	0.3	300	
HBLS2012-12N□	12	10	100	2450	0.3	300	
HBLS2012-15N□	15	10	100	2000	0.4	300	
HBLS2012-18N□	18	10	100	1750	0.45	300	
HBLS2012-22N□	22	10	100	1700	0.5	300	
HBLS2012-27N□	27	10	100	1550	0.55	300	
HBLS2012-33N□	33	10	100	1350	0.6	300	
HBLS2012-39N□	39	13	100	1300	0.65	300	



# 深圳市宏业兴电子有限公司

Shenzhen HongyeX Electronics Co.,Ltd.

文件编号 Document number:

HYSP-HL000XX

版本编码 Version number:

A2

HBLS2012-47N□	47	15	100	1200	0.7	300	
HBLS2012-56N□	56	15	100	1150	0.75	300	
HBLS2012-68N□	68	15	100	1000	0.8	300	
HBLS2012-82N□	82	15	100	850	0.9	300	
HBLS2012-R10□	100	15	100	600	1	300	
HBLS2012-R12□	120	15	50	500	1.5	300	
HBLS2012-R15□	150	15	50	500	1.5	300	
HBLS2012-R22□	220	13	50	350	2.1	200	

\*请选用时注明公差 (B, ±0.1nH; C, ±0.2nH; S, ±0.3nH; G, ±2%; H, ±3%; J, ±5%; K, ±10%) Please specify the inductance tolerance code(B, ±0.1nH; C, ±0.2nH; S, ±0.3nH; G, ±2%; H, ±3%; J, ±5%; K, ±10%).