

YTS-A017-X系列

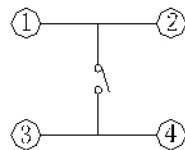

电路图
CIRCUIT DIAGRAM

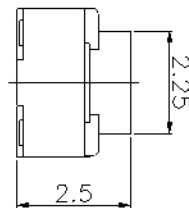
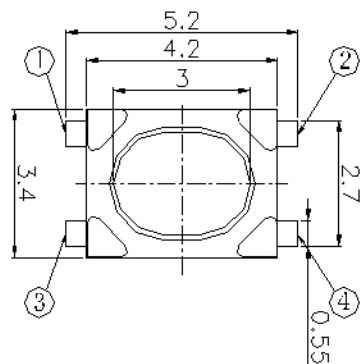
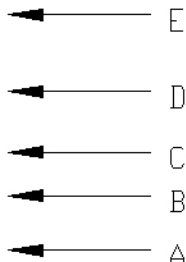
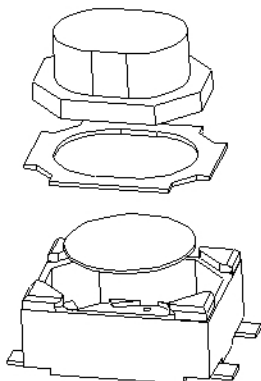
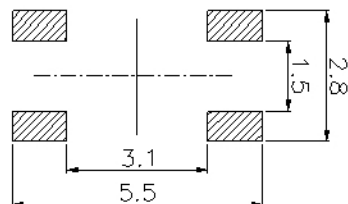

PCB. 焊接图
PCB. WELDING DRAWING

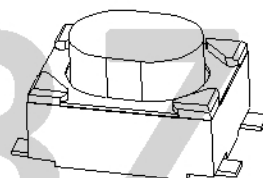
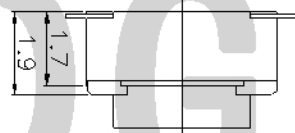

主要技术参数、性能

The Main Thonlogy Performance

额定电流、电压 Rate voltage, current	50mA DC12V
接触电阻 Contact resistance	≤100mΩ
按力 Operating force	见编码表
行程 travel	0.20±0.10mm
绝缘电阻 Insulated resistance	≥100MΩ
介电强度 Dielectric strength	≥250VAC/1min
寿命 Endurance	≥100000次

编码表

YTS	A017	X	XXX	XX	XX	X
开关	型号	等级	高度	克力	另码	包装
		A	025 (2.5mm)	18 (180g)	01~99	A散装
		B		25 (250g)		B冷封编带
						C管热
						H热封

E	按钮	PPA	1	白色
D	盖板	磷铜	1	镀铜锡
C	弹片	不锈钢	1	镀银
B	本体	LCF/FPA	1	白色
A	卡件	磷铜	1	镀银
项目 ITEM	名称 DESCRIPTION	材质 MATERIAL	数量 QTY	表面处理/颜色 FINSH/COLOR

					第一视角 FIRST VIEW			
标记 SIGN	频率 FREQUENCY	更改文件号 REVISION	签名 APPROVED	日期 DATE	比例 SCALE	1:1	一般公差 GENERAL TOLERANCE	
设计 DESIGN		赵晓峰	2017.05.17		单位 UNIT	mm	0.5~2	±0.10
审核 CHECKED		陈乐峰	2017.05.17		重量 WEIGHT		2~5	±0.25
批准 APPROVED		朱旭静	2017.05.17				5~10	±0.30
							角度 ANGLE	±0.5°

名称/NAME:	轻触开关 TACTILE SWITCH
型号/MODEL:	YTS-A017-X系列
东莞市博众电气有限公司 DONGGUAN BOZHONG ELECTRIC CO., LTD	